

ZEMĚDĚLSKÁ A KOMUNÁLNÍ TECHNIKA

AGRICULTURE AND MUNICIPAL MACHINES

LANDMASCHINEN UND KOMMUNALFAHRZEUGE

СЕЛЬСКОХОЗЯЙСТВЕННАЯ И ДОРОЖНАЯ ТЕХНИКА



2018/2019

■	✓ ZETOR	2 - 20
■	✓ NEW HOLLAND	21 - 25
■	✓ MAJÁKY / BEACONS / DREHKENNLEUCHTENN / МАЯКИ	26 - 47
■	✓ PRACOVNÍ SVĚTLOMETY / WORK LAMPS / ARBEITSSCHEINWERFER / РАБОЧИЕ ЛАМПЫ	48 - 61
■	✓ HLAVNÍ SVĚTLOMETY / HEAD LAMPS / HAUSSCHEINWERFER / ПЕРЕДНИЕ ФАРЫ	62 - 73
■	✓ PŘEDNÍ POZIČNÍ SVÍTILNY / FRONT POSITION LAMP / VORDERE POSITIONLEUCHTE / ПЕРЕДНЕГО УКАЗАТЕЛЯ ПОВОРОТА	74 - 86
■	✓ ZADNÍ SKUPINOVÉ SVÍTILNY / REAR LAMPS / HECKLEUCHTEN / ЗАДНИЕ ФОНАРИ	87 - 152
■	✓ SADA ZADNÍCH SKUPINOVÝCH SVÍTILEN / SET REAR LAMP / SET HECKLEUCHTE / KIT - ЗАДНИЕ ФОНАРИ	153 - 159
■	✓ POZIČNÍ SVĚTLA, OBRYSOVÁ SVĚTLA, OSVĚTLENÍ SPZ / MARKER LAMPS, OUTLINE MARKER LAMPS, ILLUMINATION FOR NUMBERPLATE / POSITIONSLEUCHTEN, UMRISSELEUCHTEN, KENNZEICHENLEUCHTE/ ГАБАРИТНЫЕ ЛАМПЫ, КОНТУРНЫЕ ЛАМПЫ, ФОНАРЬ ПОДСВЕТКИ НОМЕРНОГО ЗНАКА	160 - 218
■	✓ REFLEXNÍ TABULE / REAR MARKER BOARDS / WARTAFEL SET / СВЕТООТРАЖАЮЩИЕ ТАБЛИЦЫ	219 - 239
■	✓ KAMEROVÉ SYSTÉMY / CAMERA SYSTEMS / KAMERASYSTEME / СИСТЕМЫ ВИДЕОНАБЛЮДЕНИЯ	240 - 250
■	✓ ODRAZKY / REFLECTORS / STRAHLER / СВЕТООТРАЖАТЕЛИ	251 - 254
■	✓ KABELY - ZÁSUVKY - ZÁSTRČKY / CABLES - PLUGS - SOCKETS / KABEL - STECKER - STECKDOSE / КАБЕЛИ - РОЗЕТКИ - ВИЛКИ	255 - 262
■	✓ OBSAH / INDEX / INHALT / СОДЕРЖАНИЕ	263 - 269
■	✓ REJSTŘÍK / CROSS REFERENCE LIST / GEGENÜBERSTELLUNG HERSTELLER / СРАВНИТЕЛЬНАЯ ТАБЛИЦА ОРИГИНАЛЬНЫХ НОМЕРОВ	270 - 273

ZETOR

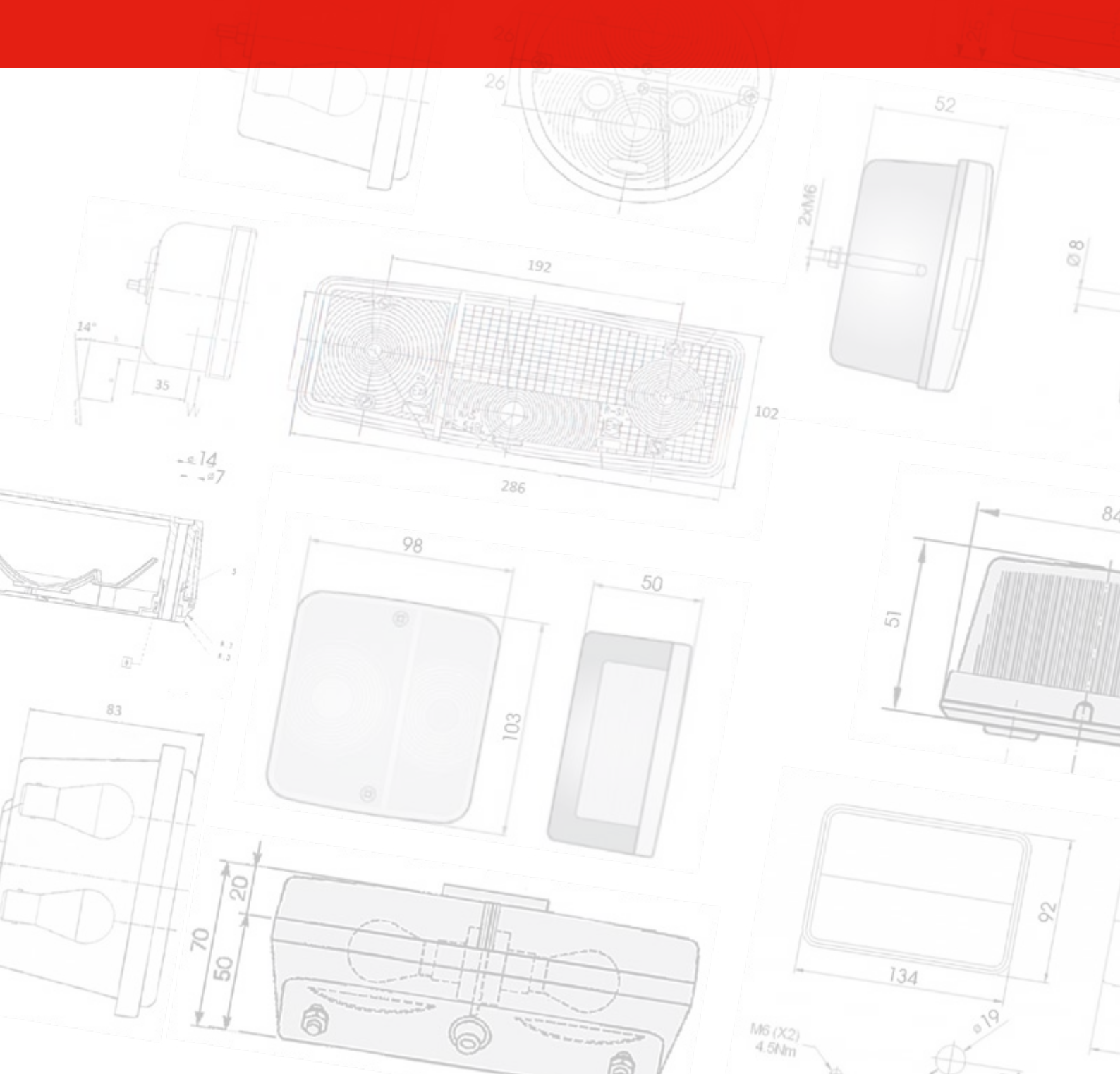

KÓD / ORDER CODE / BESTELL NR. / КОД	ZETOR: Major UŘ I 1980 - 1993	POPIS / DESCRIPTION/ BESCHREIBUNG / ОПИСАНИЕ	OE / OE NUMBER / OE NUMBER / OE	
722354 PRAVÁ / RIGHT / RECHTS / ПРАВАЯ		<p>IP 54 </p> <ul style="list-style-type: none"> ■ Uchycení: na šrouby ■ Mounting: screw ■ Крепление: болты ■ Montage: schrauben 	5911-5717	
722355 LEVÁ / LEFT / LINKS / ЛЕВАЯ			5911-5718	
		722992	12V	R2 12V, P45t
		722993	24V	R2 24V, P45t

KÓD / ORDER CODE / BESTELL NR. / КОД	ZETOR: Major UŘ I 1977 - 1984	POPIS / DESCRIPTION/ BESCHREIBUNG / ОПИСАНИЕ	OE / OE NUMBER / OE NUMBER / OE
728384 PRAVÁ / RIGHT / RECHTS / ПРАВАЯ		<p>IP 54 </p> <p>Material: Plastic</p> <ul style="list-style-type: none"> ■ Uchycení: matice + šroub M8 ■ Mounting: screw + nut M8 ■ Montage: schraube + mutter M8 ■ Крепление: гайки + болты M8 	97-6717
728385 LEVÁ / LEFT / LINKS / ЛЕВАЯ			97-6716

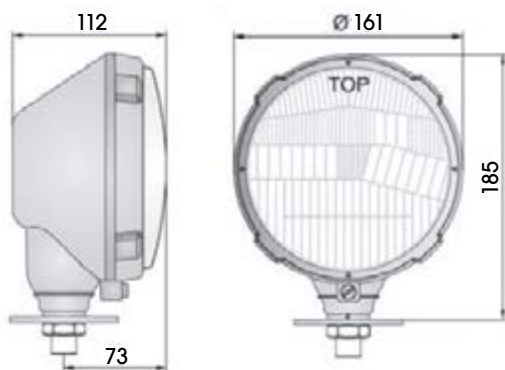

722915	12V	H4 12V, 55/60W
722948	12V	T4W 12V, BA9s
722916	24V	H4 24V, 70/75W
722949	24V	T4W 24V, BA9s

KÓD / ORDER CODE / BESTELL NR. / КОД	ZETOR: UŘ II	POPIS / DESCRIPTION/ BESCHREIBUNG / ОПИСАНИЕ	OE / OE NUMBER / OE NUMBER / OE
728386		<p>12-24 V IP 54</p> <p>Material: Plastic</p> <ul style="list-style-type: none"> ■ Rozměr: 139 mm ■ Dimensions: 139 mm ■ Das mass: 139 mm ■ УРазмеры: 139 mm 	89-352-904 89-352-903

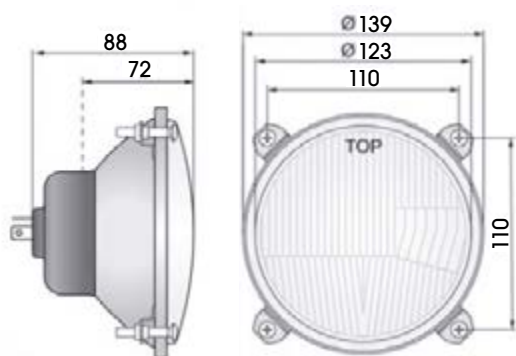

722992	12V	R2 12V, P45t
722993	24V	R2 24V, P45t

KÓD / ORDER CODE / BESTELL NR. / КОД	ZETOR: Proxima, Forterra, Crystal	POPIS / DESCRIPTION/ BESCHREIBUNG / ОПИСАНИЕ	OE / OE NUMBER / OE NUMBER / OE
727151		<p>Material: Plastic</p> <ul style="list-style-type: none"> ■ Součást hlavního světlometu ZETOR ■ Part of the headlight ZETOR ■ Ein Teil des Scheinwerfers ZETOR ■ Часть фары ZETOR 	05.1193.0000 55.350.904

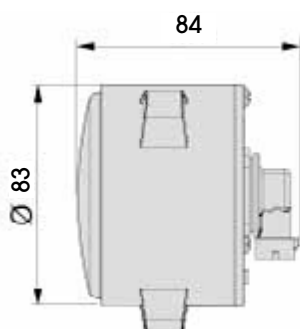

722996	12V	H9 12V, PGJ-19-5
--------	-----	------------------

Opravná sada / Repair kit / Abschlussatz / Ремонтный комплект

720360	
--------	---

KÓD / ORDER CODE / BESTELL NR. / КОД	ZETOR: Forterra, Crystal	POPIS / DESCRIPTION/ BESCHREIBUNG / ОПИСАНИЕ	OE / OE NUMBER / OE NUMBER / OE
727155	 	 <ul style="list-style-type: none"> ■ Hlavní světlomet ZETOR ■ Head lamp ZETOR ■ Hauptschein werfer ZETOR ■ Передние фары ZETOR 	05.1392.0000

722986	12V	HB3 12V, P20d
--------	-----	---------------

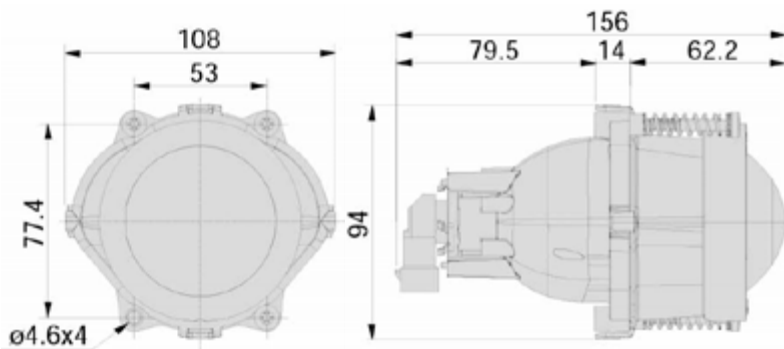

KÓD / ORDER CODE / BESTELL NR. / КОД	ZETOR: Major, Proxima, Forterra	POPIS / DESCRIPTION/ BESCHREIBUNG / ОПИСАНИЕ	OE / OE NUMBER / OE NUMBER / OE
727152	 	 <ul style="list-style-type: none"> ■ Hlavní světlomet ZETOR ■ Head lamp ZETOR ■ Hauptschein werfer ZETOR ■ Передние фары ZETOR 	05.1316.0000 55.350.902

722924	12V	H7 12V 55W, Px26d
722925	24V	H7 24V 70W, Px26d

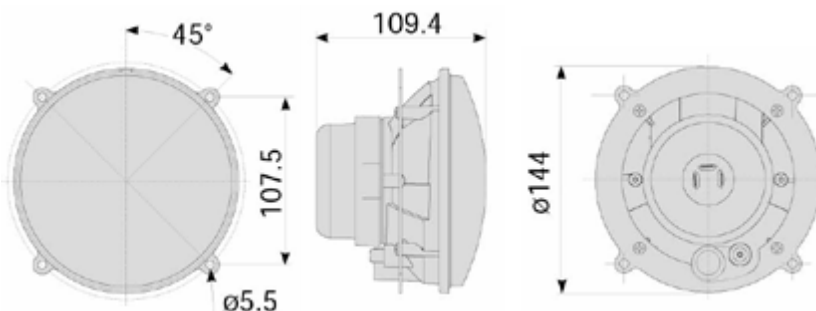

KÓD / ORDER CODE / BESTELL NR. / КОД	ZETOR: Major UŘ I 1997 - 2004	POPIS / DESCRIPTION/ BESCHREIBUNG / ОПИСАНИЕ	OE / OE NUMBER / OE NUMBER / OE
728377		<p>IP 54 </p> <ul style="list-style-type: none"> ■ Rozteč šroubů: 160 mm ■ Screws pitch: 160 mm ■ Schrauben Tonhöhe: 160 mm ■ длина между винтами: 160 mm 	1AB006213-001

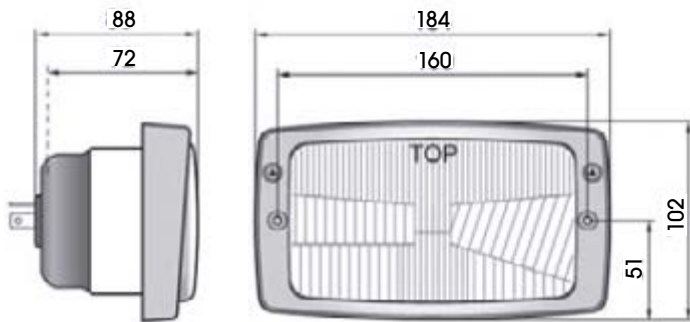

722915	12V	H4 12V, 55/60W
722948	12V	T4W 12V, BA9s
722916	24V	H4 24V, 70/75W
722949	24V	T4W 24V, BA9s

KÓD / ORDER CODE / BESTELL NR. / КОД	ZETOR: Major UŘ I 1997 - 2004	POPIS / DESCRIPTION/ BESCHREIBUNG / ОПИСАНИЕ	OE / OE NUMBER / OE NUMBER / OE
728389		<p>IP 54 </p> <ul style="list-style-type: none"> ■ Rozteč šroubů: 160 mm ■ Screws pitch: 160 mm ■ Schrauben Tonhöhe: 160 mm ■ длина между винтами: 160 mm 	1AB006213-001 53.351.946 53.351.917

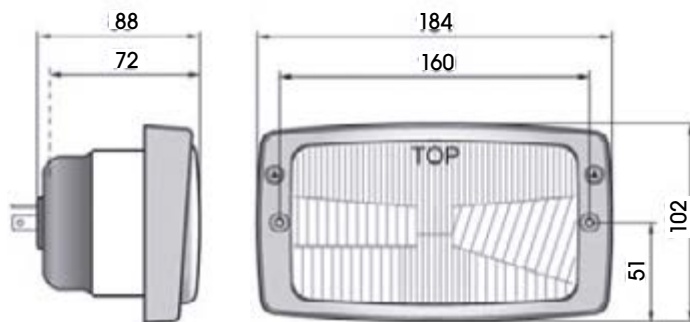

722915	12V	H4 12V 55/60W
722916	24V	H4 24V 70/75W

KÓD / ORDER CODE / BESTELL NR. / КОД	ZETOR: Proxima 2003 - 2008, Forterra 2007	POPIS / DESCRIPTION/ BESCHREIBUNG / ОПИСАНИЕ	OE / OE NUMBER / OE NUMBER / OE
728378		<p>IP 54 E</p> <ul style="list-style-type: none"> Uchycení: matice + šroub M10 Mounting: screw + nut M10 Montage: schraube + mutter M10 Крепление: гайки + болты M10 	53.351.049 53.351.050

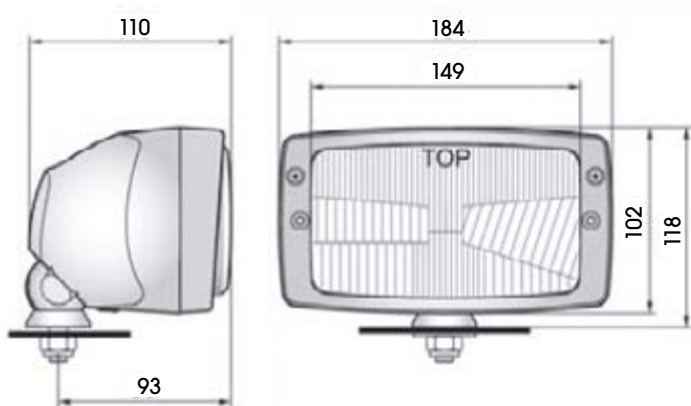

722915	12V	H4 12V, 55/60W
722948	12V	T4W 12V, BA9s
722916	24V	H4 24V, 70/75W
722949	24V	T4W 24V, BA9s

KÓD / ORDER CODE / BESTELL NR. / КОД	ZETOR: Proxima 2003 - 2008, Forterra 2007	POPIS / DESCRIPTION/ BESCHREIBUNG / ОПИСАНИЕ	OE / OE NUMBER / OE NUMBER / OE
728388		<p>IP 54 E</p> <ul style="list-style-type: none"> Uchycení: matice + šroub M10 Mounting: screw + nut M10 Montage: schraube + mutter M10 Крепление: гайки + болты M10 	53.351.049

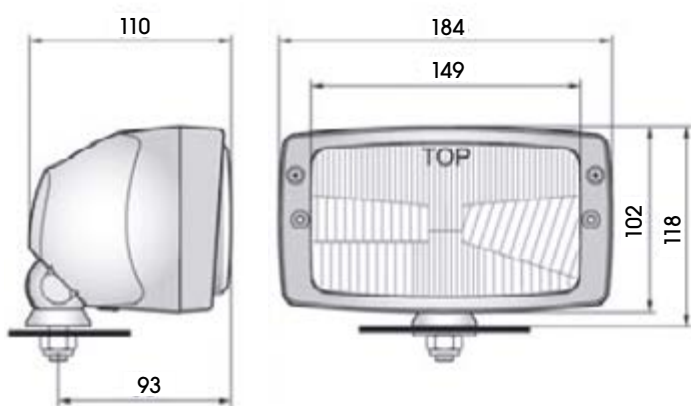

722915	12V	H4 12V, 55/60W
722916	24V	H4 24V, 70/75W

KÓD / ORDER CODE / BESTELL NR. / КОД	ZETOR: Major 80	POPIS / DESCRIPTION/ BESCHREIBUNG / ОПИСАНИЕ	OE / OE NUMBER / OE NUMBER / OE
726815	 	<p></p> <ul style="list-style-type: none"> Uchycení: 2x matice + šroub M6 Mounting: 2x screw + nut M6 Montage: 2x schraube + mutter M6 Крепление: 2 гайки + болты М6 	2BE343130-001

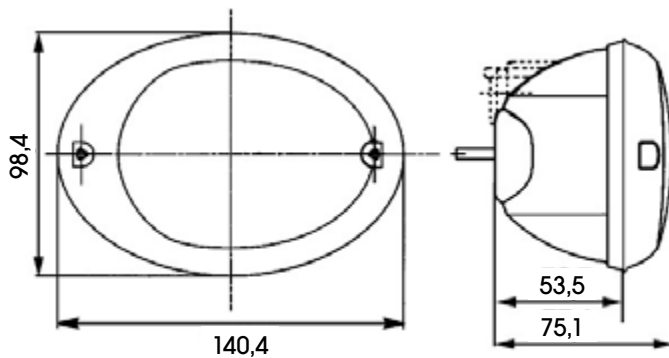

722931	12V	P21W 12V, BA15s
722943	12V	R10W 12V, BA15s
722932	24V	P21W 24V, BA15s
722944	24V	R10W 24V, BA15s

Průchodka / Grommet / Verschraubung / Прокладка

724360



KÓD / ORDER CODE / BESTELL NR. / КОД	ZETOR: Major, Proxima, Forterra, Crystal	POPIS / DESCRIPTION/ BESCHREIBUNG / ОПИСАНИЕ	OE / OE NUMBER / OE NUMBER / OE
724687	 	<p></p> <ul style="list-style-type: none"> Uchycení: 2x matice + šroub M6 Mounting: 2x screw + nut M6 Montage: 2x schraube + mutter M6 Крепление: 2 гайки + болты М6 	2BE343130-411 AG630090

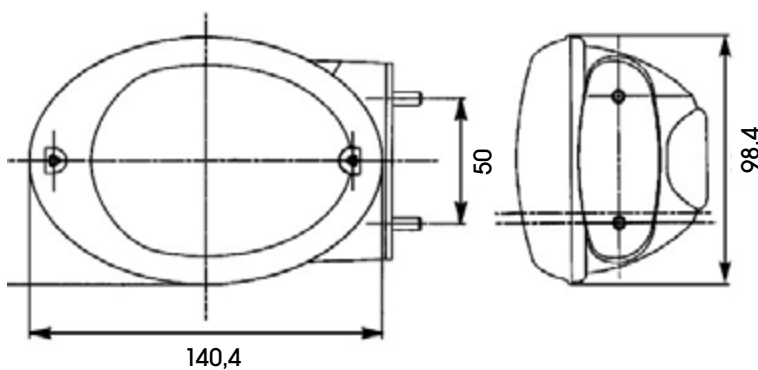

722931	12V	P21W 12V, BA15s
722943	12V	R10W 12V, BA15s
722932	24V	P21W 24V, BA15s
722944	24V	R10W 24V, BA15s

KÓD / ORDER CODE / BESTELL NR. / КОД	ZETOR: Major, Proxima, Forterra, Crystal	POPIS / DESCRIPTION/ BESCHREIBUNG / ОПИСАНИЕ	OE / OE NUMBER / OE NUMBER / OE
724616 PRAVÁ / RIGHT / RECHTS / ПРАВАЯ		<p>IP 55 E</p> <ul style="list-style-type: none"> Uchycení: 2x matice + šroub M5, kabel 1,5 m Mounting: 2x screw + nut M5, cable 1,5 m Montage: 2x schraube + mutter M5, kabel 1,5 m Крепление: 2 гайки + болты M5, кабель 1,5 m 	03.0665.0000
724617 LEVÁ / LEFT / LINKS / ЛЕВАЯ			19.351.909

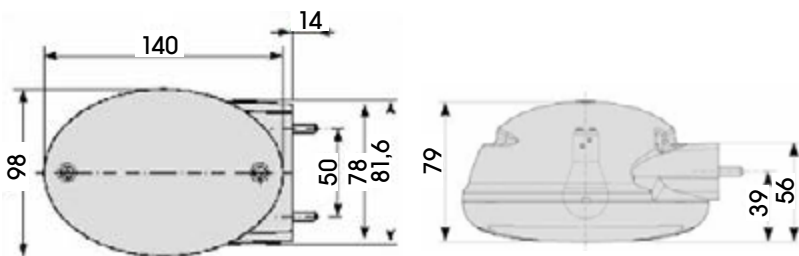

722931	12V	P21W 12V, BA15s
722940	12V	R5W 12V, BA15s
722932	24V	P21W 24V, BA15s
722941	24V	R5W 24V, BA15s

KÓD / ORDER CODE / BESTELL NR. / КОД	ZETOR: Major HS 80	POPIS / DESCRIPTION/ BESCHREIBUNG / ОПИСАНИЕ	OE / OE NUMBER / OE NUMBER / OE
724612		<p>IP 55 E</p> <ul style="list-style-type: none"> Uchycení: 2x matice + šroub M5 Mounting: 2x screw + nut M5 Montage: 2x schraube + mutter M5 Крепление: 2 гайки + болты M5 	

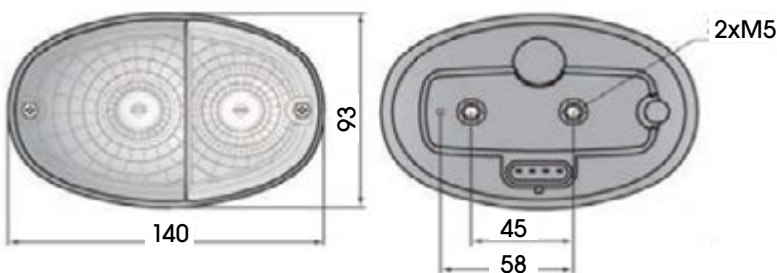







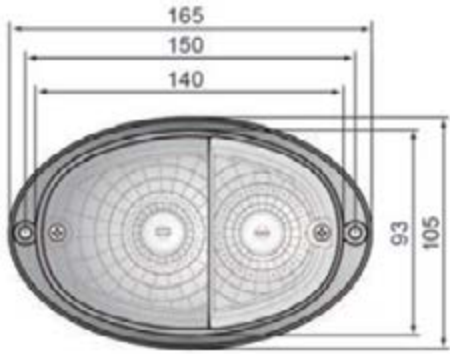

722940	12V	R5W 12V, BA15s
722931	12V	P21W 12V, BA15s
722941	24V	R5W 24V, BA15s
722932	24V	P21W 24V, BA15s

Opravná sada / Repair kit / Abschlussatz / Ремонтный комплект

721032



KÓD / ORDER CODE / BESTELL NR. / КОД	ZETOR: Major 80	POPIS / DESCRIPTION/ BESCHREIBUNG / ОПИСАНИЕ	OE / OE NUMBER / OE NUMBER / OE												
724613		<p>IP 55 </p> <ul style="list-style-type: none"> ▪ Rozteč šroubů: 150 mm ▪ Screws pitch: 150 mm ▪ Schrauben Tonhöhe: 150 mm ▪ длина между винтами: 150 mm 													
		<table border="1"> <tr> <td>722940</td> <td>12V</td> <td>R5W 12V, BA15s</td> </tr> <tr> <td>722931</td> <td>12V</td> <td>P21W 12V, BA15s</td> </tr> <tr> <td>722941</td> <td>24V</td> <td>R5W 24V, BA15s</td> </tr> <tr> <td>722932</td> <td>24V</td> <td>P21W 24V, BA15s</td> </tr> </table>	722940	12V	R5W 12V, BA15s	722931	12V	P21W 12V, BA15s	722941	24V	R5W 24V, BA15s	722932	24V	P21W 24V, BA15s	
722940	12V	R5W 12V, BA15s													
722931	12V	P21W 12V, BA15s													
722941	24V	R5W 24V, BA15s													
722932	24V	P21W 24V, BA15s													
		<p>Opravná sada / Repair kit / Abschlussatz / Ремонтный комплект</p> <table border="1"> <tr> <td data-bbox="943 965 1086 1093">721032</td> <td data-bbox="1091 965 1230 1093"></td> <td data-bbox="1235 965 1513 1093">  </td> </tr> <tr> <td data-bbox="943 1099 1086 1214">721059</td> <td data-bbox="1091 1099 1230 1214"></td> <td data-bbox="1235 1099 1513 1214">  </td> </tr> </table>	721032			721059									
721032															
721059															

KÓD / ORDER CODE / BESTELL NR. / КОД	ZETOR: Major, Proxima, Forterra, Crystal	POPIS / DESCRIPTION/ BESCHREIBUNG / ОПИСАНИЕ	OE / OE NUMBER / OE NUMBER / OE												
724614		<p>IP 55 </p> <ul style="list-style-type: none"> ▪ Uchycení: 2x Matice + šroub M5 ▪ Mounting: 2x screw + nut M5 ▪ Montage: 2x schraube + mutter M5 ▪ Крепление: 2 гайки + болты M5 													
		<table border="1"> <tr> <td>722940</td> <td>12V</td> <td>R5W 12V, BA15s</td> </tr> <tr> <td>722931</td> <td>12V</td> <td>P21W 12V, BA15s</td> </tr> <tr> <td>722941</td> <td>24V</td> <td>R5W 24V, BA15s</td> </tr> <tr> <td>722932</td> <td>24V</td> <td>P21W 24V, BA15s</td> </tr> </table>	722940	12V	R5W 12V, BA15s	722931	12V	P21W 12V, BA15s	722941	24V	R5W 24V, BA15s	722932	24V	P21W 24V, BA15s	
722940	12V	R5W 12V, BA15s													
722931	12V	P21W 12V, BA15s													
722941	24V	R5W 24V, BA15s													
722932	24V	P21W 24V, BA15s													

KÓD / ORDER CODE / BESTELL NR. / КОД	ZETOR: Major UŘ I 1984 - 1993, 1997 - 2004, 1992 - 2006, Forterra 2007	POPIS / DESCRIPTION/ BESCHREIBUNG / ОПИСАНИЕ	OE / OE NUMBER / OE NUMBER / OE
726887		<p>IP 55 </p> <ul style="list-style-type: none"> Uchyceni: 2x matice + řroub M5 Mounting: 2x screw + nut M5 Montage: 2x schraube + mutter M5 Крепление: 2 гайки + болты M5 	443312184104 16.351.039 15.351.039 16.351.049 15.351.049 78.351.549

722940	12V	R5W 12V, BA15s
722931	12V	P21W 12V, BA15s

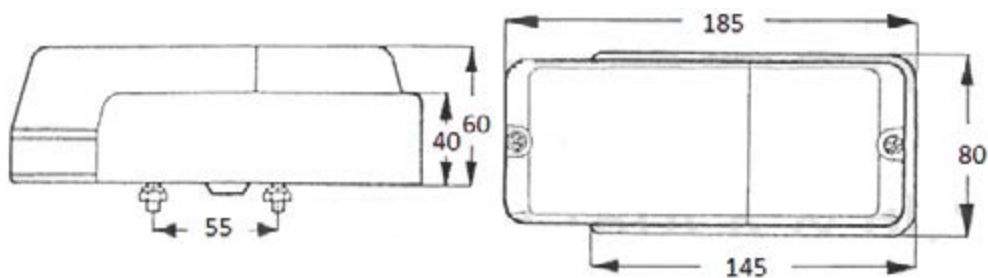

KÓD / ORDER CODE / BESTELL NR. / КОД	ZETOR: Major 1977 - 1980, 1984 - 1993	POPIS / DESCRIPTION/ BESCHREIBUNG / ОПИСАНИЕ	OE / OE NUMBER / OE NUMBER / OE
726888		<p>IP 55 </p> <ul style="list-style-type: none"> Uchyceni: 2x matice + řroub M5 Mounting: 2x screw + nut M5 Montage: 2x schraube + mutter M5 Крепление: 2 гайки + болты M5 	6011-5805/8 6011-5805 6711-5710

722940	12V	R5W 12V, BA15s
722931	12V	P21W 12V, BA15s
722941	24V	R5W 24V, BA15s
722932	24V	P21W 24V, BA15s

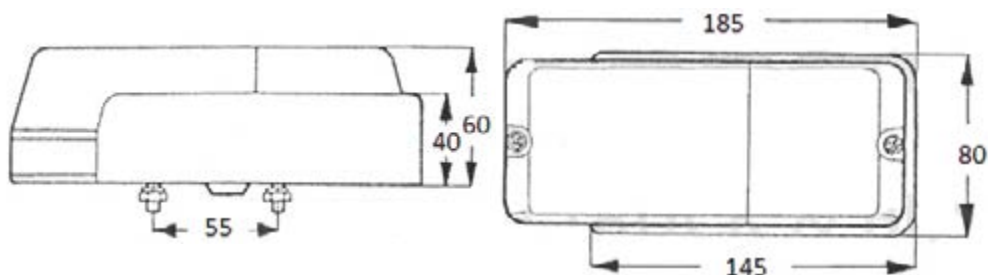

KÓD / ORDER CODE / BESTELL NR. / КОД	ZETOR: Proxima, Forterra	POPIS / DESCRIPTION/ BESCHREIBUNG / ОПИСАНИЕ	OE / OE NUMBER / OE NUMBER / OE
728392 PRAVÁ / RIGHT / RECHTS / ПРАВАЯ		<p>IP 55 E</p> <ul style="list-style-type: none"> Uchycení: 2x matice + šroub M6 Mounting: 2x screw + nut M6 Montage: 2x schraube + mutter M6 Крепление: 2 гайки + болты M6 	93-5574
728393 LEVÁ / LEFT / LINKS / ЛЕВАЯ			93-5575

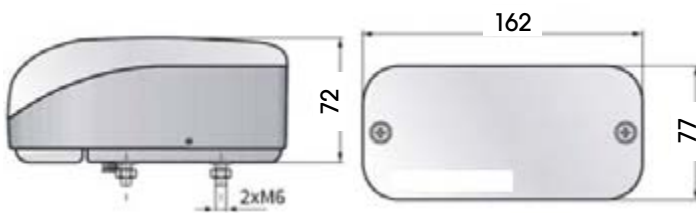

722934	12V	PY21W 12V, BAU15s
722940	12V	R5W 12V, BA15s
722935	24V	PY21W 24V, BAU15s
722941	24V	R5W 24V, BA15s

**2 KOMOROVÉ KONCOVÉ – BRZDOVÉ – SMĚROVÉ, PLASTOVÉ POUZDRO / 2-CHAMBER LIGHT TAIL – STOP – FLASHER LAMP, PLASTIC HOUSING /
2-KAMMER LEUCHTE SCHLUSS – BREMS – BLINKLEUCHTE, KUNSTSTOFFGEHÄUSE /
2-ФУНКЦИОНАЛЬНАЯ ЗАДНЯЯ ФАРА–ЛАМПА СИГНАЛА СТОП, ТОРМОЖЕНИЯ–УКАЗАТЕЛЬ ПОВОРОТА, ПЛАСТИКОВЫЙ КОРПУС**

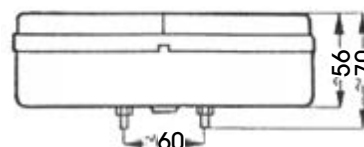
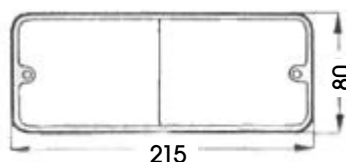

KÓD / ORDER CODE / BESTELL NR. / КОД	OE / OE NUMBER / OE NUMMER / OE	PRAVÁ / RIGHT / RECHTS / ПРАВАЯ	LEVÁ / LEFT / LINKS / ЛЕВАЯ	OSVĚTLENÍ SPZ / ILLUMINATION FOR NUMBERPLATE / KENNZEICHENLEUCHTE / ПОДСВЕТКА НОМЕРНОГО ЗНАКА	PŘIPOJENÍ / CONNECTION / ANSCHLUSS / СОЕДИНЕНИЕ	
726872	6711-5711 443312251104	■				
726873	6711-5712 443312252104		■			
726870 - KRYT / LENS / LICHTSCHEIBE / КРЫШКА	443312251104	■				
726871 - KRYT / LENS / LICHTSCHEIBE / КРЫШКА	443312252104		■			
				722937	12V	P21 5W 12V, BAY15d
				722934	12V	PY21W 12V, BAU15s
				722938	24V	P21 5W 24V, BAY15d
				722935	24V	PY21W 24V, BAU15s

**2 KOMOROVÉ KONCOVÉ – BRZDOVÉ – SMĚROVÉ, PLECHOVÉ POUZDRO / 2-CHAMBER LIGHT TAIL – STOP – FLASHER LAMP, METAL HOUSING /
2-KAMMER LEUCHTE SCHLUSS – BREMS – BLINKLEUCHTE, METALLGEHÄUSE /
2-ФУНКЦИОНАЛЬНАЯ ЗАДНЯЯ ФАРА–ЛАМПА СИГНАЛА СТОП, ТОРМОЖЕНИЯ–УКАЗАТЕЛЬ ПОВОРОТА, МЕТАЛЛИЧЕСКИЙ КОРПУС**

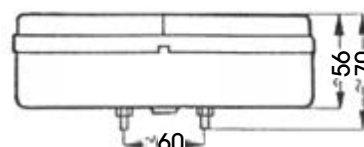
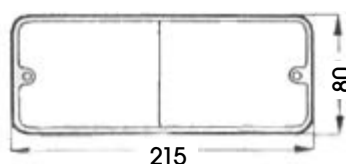

KÓD / ORDER CODE / BESTELL NR. / КОД	OE / OE NUMBER / OE NUMMER / OE	PRAVÁ / RIGHT / RECHTS / ПРАВАЯ	LEVÁ / LEFT / LINKS / ЛЕВАЯ	OSVĚTLENÍ SPZ / ILLUMINATION FOR NUMBERPLATE / KENNZEICHENLEUCHTE / ПОДСВЕТКА НОМЕРНОГО ЗНАКА	PŘIPOJENÍ / CONNECTION / ANSCHLUSS / СОЕДИНЕНИЕ	
726895	443312251104	■				
726896	443312252104		■			
726870 - KRYT / LENS / LICHTSCHEIBE / КРЫШКА	443312251104	■				
726871 - KRYT / LENS / LICHTSCHEIBE / КРЫШКА	443312252104		■			
				722937	12V	P21 5W 12V, BAY15d
				722934	12V	PY21W 12V, BAU15s
				722938	24V	P21 5W 24V, BAY15d
				722935	24V	PY21W 24V, BAU15s

ZETOR: Major



**2 KOMOROVÉ KONCOVÉ - BRZDOVÉ - SMĚROVÉ / 2-CHAMBER LIGHT TAIL - STOP - FLASHER LAMP /
2-KAMMER LEUCHTE SCHLUSS - BREMS - BLINKLEUCHTE /
2-ФУНКЦИОНАЛЬНАЯ ЗАДНЯЯ ФАРА-ЛАМПА СИГНАЛА СТОП, ТОРМАЖЕНИЯ-УКАЗАТЕЛЬ ПОВОРОТА**

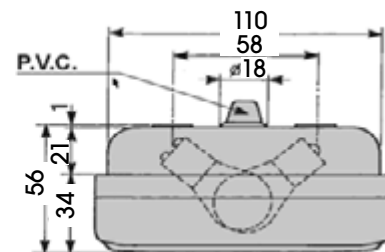
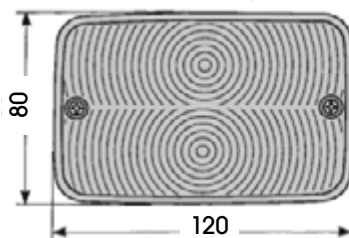

KÓD / ORDER CODE / BESTELL NR. / КОД	OE / OE NUMBER / OE NUMMER / OE	PRAVÁ / RIGHT / RECHTS / ПРАВАЯ	LEVÁ / LEFT / LINKS / ЛЕВАЯ	OSVĚTLENÍ SPZ / ILLUMINATION FOR NUMBERPLATE / KENNZEICHENLEUCHTE / ПОДСВЕТКА НОМЕРНОГО ЗНАКА	PŘIPOJENÍ / CONNECTION / ANSCHLUSS / СОЕДИНЕНИЕ	
723063	02.394.000	■	■			
723062 KRYT / LENS / LICHTSCHEIBE / Крышка	02.394.020	■	■			
				722934	12 V	PY21W 12V, BAU15s
				722937	12 V	P21 5W 12V, BAY15d
				722935	24 V	PY21W 24V, BAU15s
				722938	24 V	P21 5W 24V, BAY15d

ZETOR: Major

**2 KOMOROVÉ KONCOVÉ - BRZDOVÉ - SMĚROVÉ / 2-CHAMBER LIGHT TAIL - STOP - FLASHER LAMP /
2-KAMMER LEUCHTE SCHLUSS - BREMS - BLINKLEUCHTE /
2-ФУНКЦИОНАЛЬНАЯ ЗАДНЯЯ ФАРА-ЛАМПА СИГНАЛА СТОП, ТОРМАЖЕНИЯ-УКАЗАТЕЛЬ ПОВОРОТА**

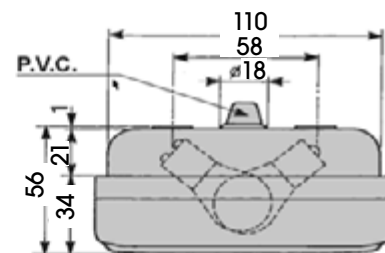
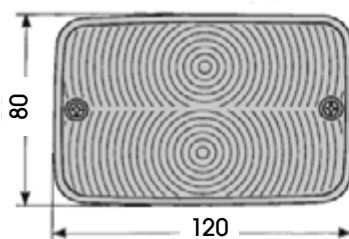

KÓD / ORDER CODE / BESTELL NR. / КОД	OE / OE NUMBER / OE NUMMER / OE	PRAVÁ / RIGHT / RECHTS / ПРАВАЯ	LEVÁ / LEFT / LINKS / ЛЕВАЯ	OSVĚTLENÍ SPZ / ILLUMINATION FOR NUMBERPLATE / KENNZEICHENLEUCHTE / ПОДСВЕТКА НОМЕРНОГО ЗНАКА	PŘIPOJENÍ / CONNECTION / ANSCHLUSS / СОЕДИНЕНИЕ	
723063/N	02.394.000	■	■			
723062/N KRYT / LENS / LICHTSCHEIBE / Крышка	02.394.020	■	■			
				722934	12 V	PY21W 12V, BAU15s
				722937	12 V	P21 5W 12V, BAY15d
				722935	24 V	PY21W 24V, BAU15s
				722938	24 V	P21 5W 24V, BAY15d

ZETOR: UŘ I 1997 - 2004, Proxima 2003 - 2008

3 KOMOROVÉ SVĚTLO - KONCOVÉ - BRZDOVÉ - SMĚROVÉ / 3-CHAMBER LIGHT - STOP - FLASHER LAMP/ 3-KAMMER LEUCHTE - SCHLUSS - BREMS - BLINKLEUCHTE/ 3 ФУНКЦИОНАЛЬНАЯ ЗАДНЯЯ ФАРА-ЛАМПА СИГНАЛА СТОП, ТОРМАЖЕНИЯ IP 55

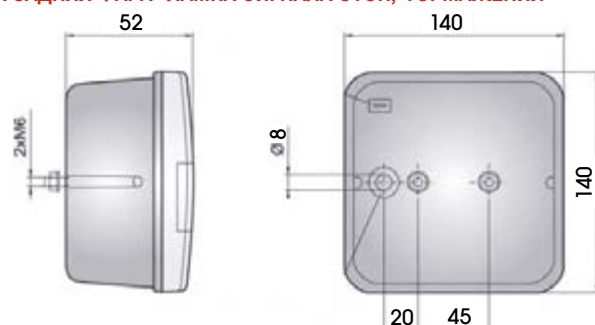

KÓD / ORDER CODE / BESTELL NR. / КОД	OE / OE NUMBER / OE NUMMER / OE	PRAVÁ / RIGHT / RECHTS / ПРАВАЯ	LEVÁ / LEFT / LINKS / ЛЕВАЯ	OSVĚTLENÍ SPZ / ILLUMINATION FOR NUMBERPLATE / KENNZEICHENLEUCHTE / ПОДСВЕТКА НОМЕРНОГО ЗНАКА	PŘIPOJENÍ / CONNECTION / ANSCHLUSS / СОЕДИНЕНИЕ
720258	53.351.901	■	■		
720218 KRYT / LENS / LICHTSCHEIBE / КРЫШКА	93-3254	■	■		
				722943	12V R10W 12V, BA15s
				722931	12V P21W 12V, BA15s
				722944	24V R10W 24V, BA15s
				722932	24V P21W 24V, BA15s

3 KOMOROVÉ SVĚTLO - KONCOVÉ - BRZDOVÉ - SMĚROVÉ / 3-CHAMBER LIGHT - STOP - FLASHER LAMP/ 3-KAMMER LEUCHTE - SCHLUSS - BREMS - BLINKLEUCHTE/ 3 ФУНКЦИОНАЛЬНАЯ ЗАДНЯЯ ФАРА-ЛАМПА СИГНАЛА СТОП, ТОРМАЖЕНИЯ IP 55

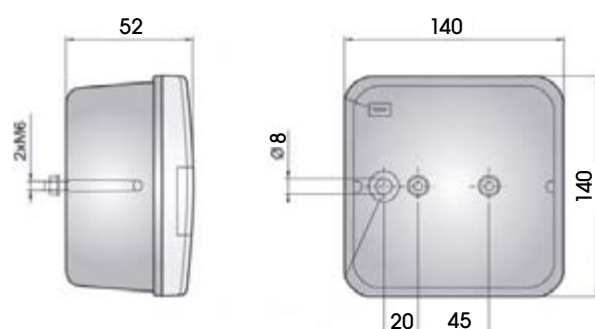

KÓD / ORDER CODE / BESTELL NR. / КОД	OE / OE NUMBER / OE NUMMER / OE	PRAVÁ / RIGHT / RECHTS / ПРАВАЯ	LEVÁ / LEFT / LINKS / ЛЕВАЯ	OSVĚTLENÍ SPZ / ILLUMINATION FOR NUMBERPLATE / KENNZEICHENLEUCHTE / ПОДСВЕТКА НОМЕРНОГО ЗНАКА	PŘIPOJENÍ / CONNECTION / ANSCHLUSS / СОЕДИНЕНИЕ
720259		■	■	■	
720218 KRYT / LENS / LICHTSCHEIBE / КРЫШКА	93-3254	■	■		
				722943	12V R10W 12V, BA15s
				722931	12V P21W 12V, BA15s
				722944	24V R10W 24V, BA15s
				722932	24V P21W 24V, BA15s

ZETOR: 3011, 4011

3 KOMOROVÉ SVĚTLO - KONCOVÉ - BRZDOVÉ - SMĚROVÉ / 3-CHAMBER LIGHT - STOP - FLASHER LAMP / 3-KAMMER LEUCHE - SCHLUSS - BREMS - BLINKLEUCHE / 3 ФУНКЦИОНАЛЬНАЯ ЗАДНЯЯ ФАРА - ЛАМПА СИГНАЛА СТОП, ТОРМАЖЕНИЯ

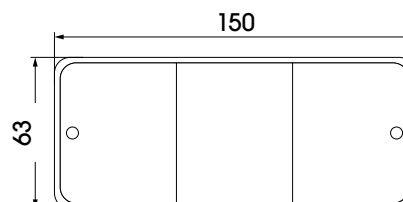

KÓD / ORDER CODE / BESTELL NR. / КОД	OE / OE NUMBER / OE NUMMER / OE	PRAVÁ / RIGHT / RECHTS / ПРАВАЯ	LEVÁ / LEFT / LINKS / ЛЕВАЯ	OSVĚTLENÍ SPZ / ILLUMINATION FOR NUMBERPLATE / KENNZEICHENLEUCHE / ПОДСВЕТКА НОМЕРНОГО ЗНАКА	PŘIPOJENÍ / CONNECTION / ANSCHLUSS / СОЕДИНЕНИЕ	
720141		■				
720142			■	■		
720100 - KRYT / LENS / LICHTSCHEIBE / КРЫШКА		■	■			
				722931	12 V	P21W 12V, BA15s
				722940	12 V	R5W 12V, BA15s
				722943	12 V	R10W 12V, BA15s
				723932	24 V	P21W 24V, BA15s
				722941	24 V	R5W 24V, BA15s
				722944	24 V	R10W 24V, BA15s

ZETOR: Major 80, Proxima, Forterra, Crystal

2 KOMOROVÉ KONCOVÉ - BRZDOVÉ - SMĚROVÉ / 2-CHAMBER LIGHT TAIL - STOP - FLASHER LAMP / 2-KAMMER LEUCHE SCHLUSS - BREMS - BLINKLEUCHE / 2-ФУНКЦИОНАЛЬНАЯ ЗАДНЯЯ ФАРА - ЛАМПА СИГНАЛА СТОП, ТОРМАЖЕНИЯ - УКАЗАТЕЛЬ ПОВОРОТА

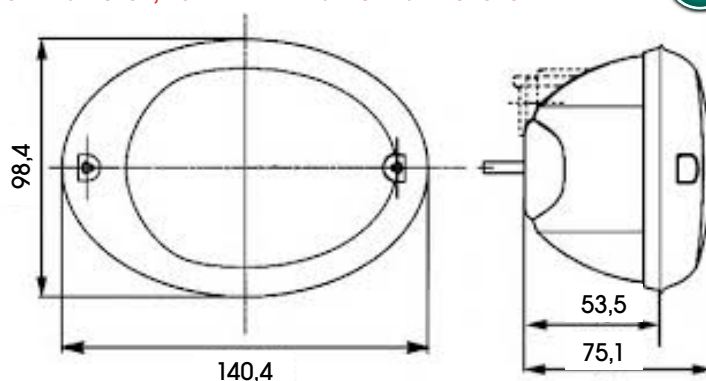

KÓD / ORDER CODE / BESTELL NR. / КОД	OE / OE NUMBER / OE NUMMER / OE	PRAVÁ / RIGHT / RECHTS / ПРАВАЯ	LEVÁ / LEFT / LINKS / ЛЕВАЯ	OSVĚTLENÍ SPZ / ILLUMINATION FOR NUMBERPLATE / KENNZEICHENLEUCHE / ПОДСВЕТКА НОМЕРНОГО ЗНАКА	PŘIPOJENÍ / CONNECTION / ANSCHLUSS / СОЕДИНЕНИЕ	
722229	2SD343130-011	■	■	■		
Průchodka / Grommet / Gummitülle / кренгельс						
724360				722931	12V	P21W 12V, BA15s
				722937	12V	P21 5W 12V, BAY15d
				722932	24V	P21W 24V, BA15s
				722938	24V	P21 5W 24V, BAY15d

ZETOR: Major 80, Proxima, Forterra, Crystal

2 KOMOROVÉ KONCOVÉ - BRZDOVÉ - SMĚROVÉ / 2-CHAMBER LIGHT TAIL - STOP - FLASHER LAMP /
2-KAMMER LEUCHE SCHLUSS - BREMS - BLINKLEUCHE /
2-ФУНКЦИОНАЛЬНАЯ ЗАДНЯЯ ФАРА-ЛАМПА СИГНАЛА СТОП/ТОРМАЖЕНИЯ-УКАЗАТЕЛЬ ПОВОРОТА

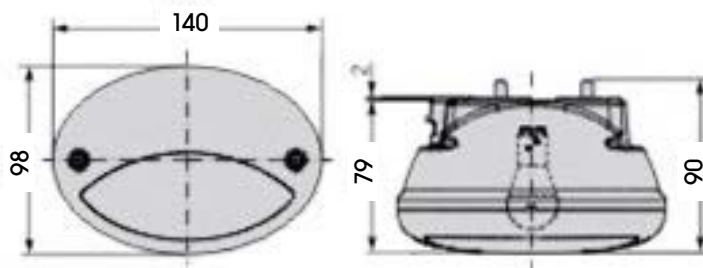

KÓD / ORDER CODE / BESTELL NR. / КОД	OE / OE NUMBER / OE NUMMER / OE	PRAVÁ / RIGHT / RECHTS / ПРАВАЯ	LEVÁ / LEFT / LINKS / ЛЕВАЯ	OSVĚTLENÍ SPZ / ILLUMINATION FOR NUMBERPLATE / KENNZEICHENLEUCHE / ПОДСВЕТКА НОМЕРНОГО ЗНАКА	PŘIPOJENÍ / CONNECTION / ANSCHLUSS / СОЕДИНЕНИЕ	
724615	02.1335.0000	■	■			
724619 KRYT / LENS / LICHTSCHEIBE / Крышка	02.1335.0200	■	■			
Opravná sada / Repair Kit / Anschlusssatz / Ремонтный комплект				722931	12V	P21W 12V, BA15s
721032 				722937	12V	P21 5W 12V, BAY15d
				722932	24V	P21W 24V, BA15s
				722938	24V	P21 5W 24V, BAY15d

ZETOR: Major 80, Proxima, Forterra, Crystal

2 KOMOROVÉ KONCOVÉ - BRZDOVÉ - SMĚROVÉ / 2-CHAMBER LIGHT TAIL - STOP - FLASHER LAMP /
2-KAMMER LEUCHE SCHLUSS - BREMS - BLINKLEUCHE /
2-ФУНКЦИОНАЛЬНАЯ ЗАДНЯЯ ФАРА-ЛАМПА СИГНАЛА СТОП, ТОРМАЖЕНИЯ-УКАЗАТЕЛЬ ПОВОРОТА



IP 55

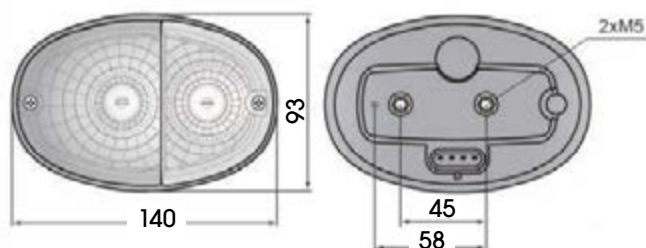

KÓD / ORDER CODE / BESTELL NR. / КОД	OE / OE NUMBER / OE NUMMER / OE	PRAVÁ / RIGHT / RECHTS / ПРАВАЯ	LEVÁ / LEFT / LINKS / ЛЕВАЯ	OSVĚTLENÍ SPZ / ILLUMINATION FOR NUMBERPLATE / KENNZEICHENLEUCHE / ПОДСВЕТКА НОМЕРНОГО ЗНАКА	PŘIPOJENÍ / CONNECTION / ANSCHLUSS / СОЕДИНЕНИЕ	
724609		■	■			
Opravná sada / Repair Kit / Anschlusssatz / Ремонтный комплект				722931	12V	P21W 12V, BA15s
721032 				722937	12V	P21 5W 12V, BAY15d
				722932	24V	P21W 24V, BA15s
				722938	24V	P21 5W 24V, BAY15d

ZETOR: Major HS 80

2 KOMOROVÉ KONCOVÉ - BRZDOVÉ - SMĚROVÉ / 2-CHAMBER LIGHT TAIL - STOP - FLASHER LAMP /
2-KAMMER LEUCHTE SCHLUSS - BREMS - BLINKLEUCHTE /
2-ФУНКЦИОНАЛЬНАЯ ЗАДНЯЯ ФАРА - ЛАМПА СИГНАЛА СТОП, ТОРМАЖЕНИЯ - УКАЗАТЕЛЬ ПОВОРОТА



IP 55

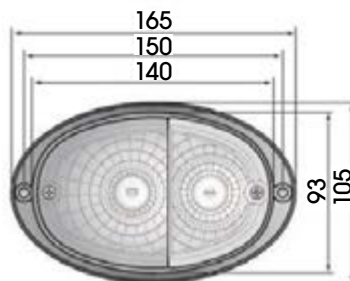

KÓD / ORDER CODE / BESTELL NR. / КОД	OE / OE NUMBER / OE NUMMER / OE	PRAVÁ / RIGHT / RECHTS / ПРАВАЯ	LEVÁ / LEFT / LINKS / ЛЕВАЯ	OSVĚTLENÍ SPZ / ILLUMINATION FOR NUMBERPLATE / KENNZEICHENLEUCHTE / ПОДСВЕТКА НОМЕРНОГО ЗНАКА	PŘIPOJENÍ / CONNECTION / ANSCHLUSS / СОЕДИНЕНИЕ
724610		■	■		
Opravná sada / Repair Kit / Anschlusssatz / Ремонтный комплект				722931	12V P21W 12V, BA15s
721032				722937	12V P21 5W 12V, BAY15d
721059				722932	24V P21W 24V, BA15s
				722938	24V P21 5W 24V, BAY15d

ZETOR: Major HS 80

2 KOMOROVÉ KONCOVÉ - BRZDOVÉ - SMĚROVÉ / 2-CHAMBER LIGHT TAIL - STOP - FLASHER LAMP /
2-KAMMER LEUCHTE SCHLUSS - BREMS - BLINKLEUCHTE /
2-ФУНКЦИОНАЛЬНАЯ ЗАДНЯЯ ФАРА - ЛАМПА СИГНАЛА СТОП, ТОРМАЖЕНИЯ - УКАЗАТЕЛЬ ПОВОРОТА



IP 55

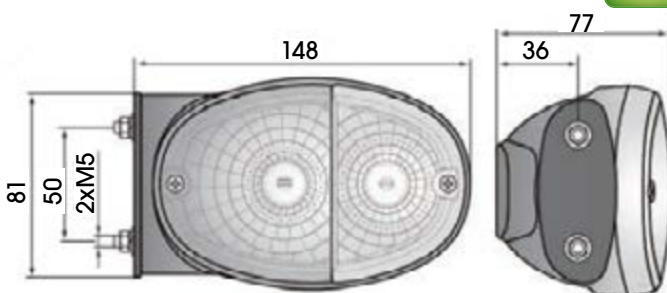

KÓD / ORDER CODE / BESTELL NR. / КОД	OE / OE NUMBER / OE NUMMER / OE	PRAVÁ / RIGHT / RECHTS / ПРАВАЯ	LEVÁ / LEFT / LINKS / ЛЕВАЯ	OSVĚTLENÍ SPZ / ILLUMINATION FOR NUMBERPLATE / KENNZEICHENLEUCHTE / ПОДСВЕТКА НОМЕРНОГО ЗНАКА	PŘIPOJENÍ / CONNECTION / ANSCHLUSS / СОЕДИНЕНИЕ
724611		■	■		
				722931	12V P21W 12V, BA15s
				722937	12V P21 5W 12V, BAY15d
				722932	24V P21W 24V, BA15s
				722938	24V P21 5W 24V, BAY15d

KÓD / ORDER CODE / BESTELL NR. / КОД	ZETOR: Major HS 80	POPIS / DESCRIPTION/ BESCHREIBUNG / ОПИСАНИЕ	OE / OE NUMBER / OE NUMBER / OE
725653	<p>1500 LUMEN</p> 	<p>9-33V IP 68 IP 69K LED WATER PROOF</p> <p>Material: aluminium, 4x LED, 18W</p> <ul style="list-style-type: none"> Uchycení: matice + šroub, kabel - 1,5 m Mounting: screw + nut, kabel - 1,5 m Montage: schraube + mutter, kabel - 1,5 m Крепление: гайки + болты, длина провода - 1,5 метра 	93-5577

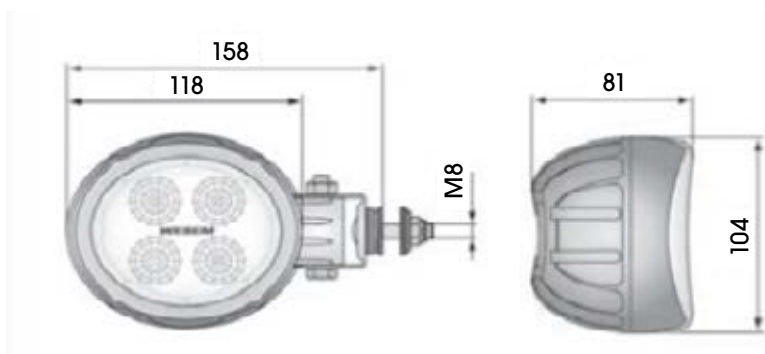

KÓD / ORDER CODE / BESTELL NR. / КОД	ZETOR: Major HS 80	POPIS / DESCRIPTION/ BESCHREIBUNG / ОПИСАНИЕ	OE / OE NUMBER / OE NUMBER / OE
725652	<p>1000 LUMEN</p> 	<p>9-33V IP 68 IP 69K LED WATER PROOF</p> <p>Material: aluminium, 4x LED, 18W</p> <ul style="list-style-type: none"> Uchycení: matice + šroub, 2x pólový konektor Mounting: screw + nut, 2x poles connector Montage: schraube + mutter, 2x pole stecker Крепление: гайки + болты, 2 полюсовый конектор 	93-5577

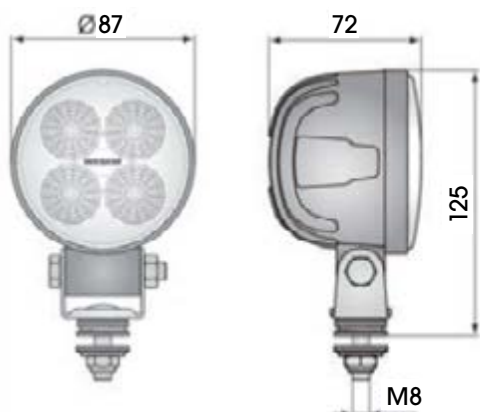

KÓD / ORDER CODE / BESTELL NR. / КОД	ZETOR: Forterra, Proxima POWER, Crystal	POPIS / DESCRIPTION/ BESCHREIBUNG / ОПИСАНИЕ	OE / OE NUMBER / OE NUMBER / OE
727149	 	 <p>Material: Plastic</p> <ul style="list-style-type: none"> ■ Uchycení matice + šroub M6 ■ Mounting: screw + nut M6 ■ Montage: schraube + mutter M6 ■ Крепление: гайки+болты + длина M6 	05.1610.0000 19.351.903

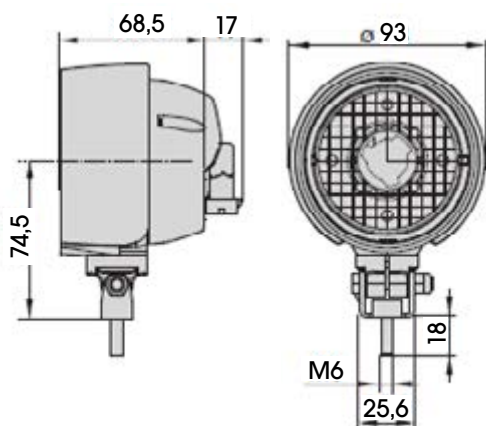

722996	12V	H9 12V, PGJ-19-5
Kabel / Cable / Кабель / Kabel		
720107		

NEW HOLLAND

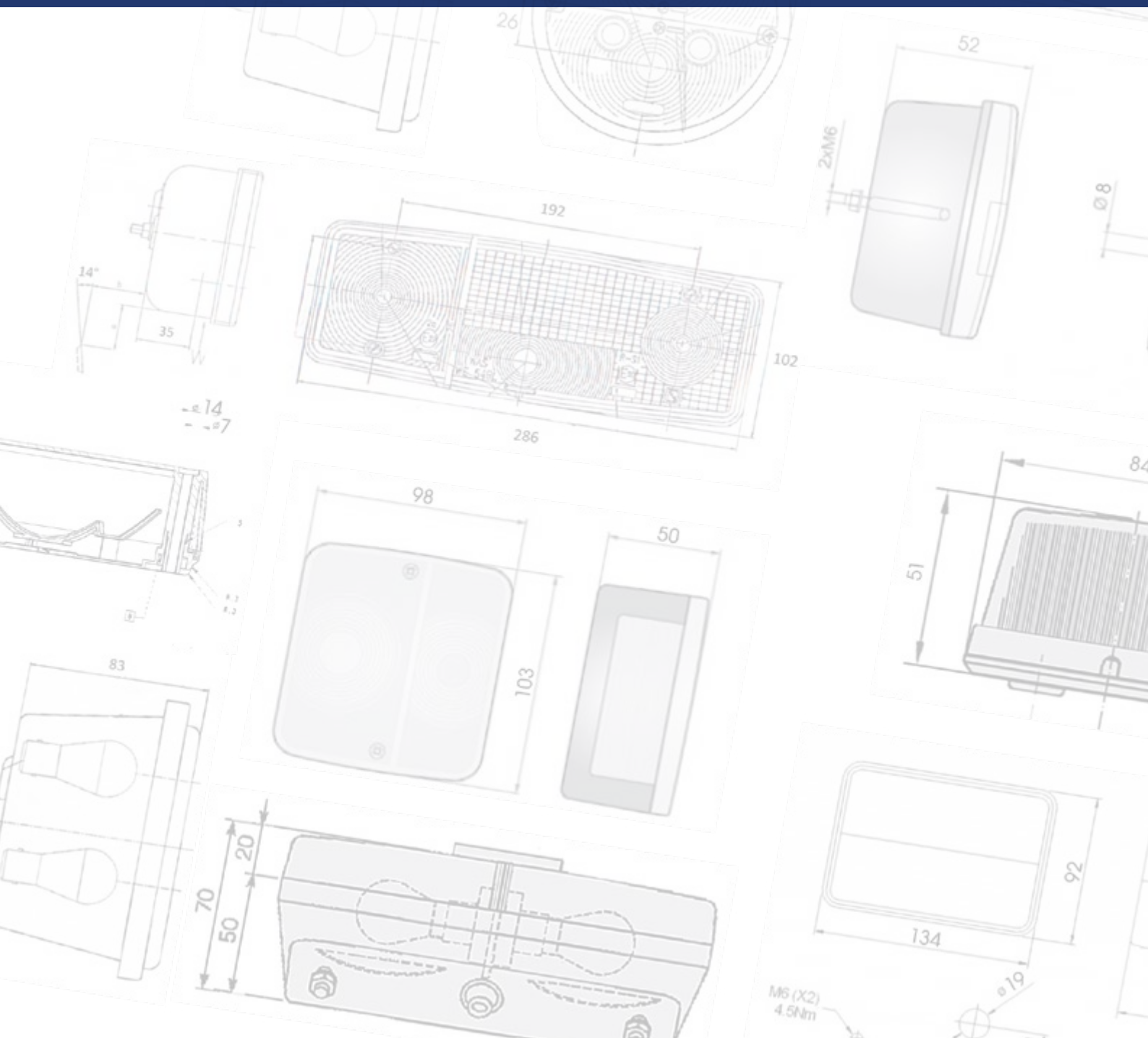

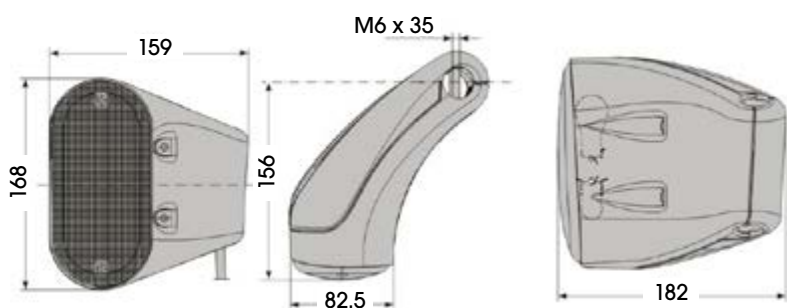

KÓD / ORDER CODE / BESTELL NR. / КОД	NEW HOLLAND, STEYR	POPIS / DESCRIPTION / BESCHREIBUNG / ОПИСАНИЕ	OE / OE NUMBER / OE NUMBER / OE
727160 PRAVÁ / RIGHT / RECHTS / ПРАВАЯ	 	 <ul style="list-style-type: none"> Uchycení: tyč, kabel 1 m Mounting: tube, cable 1 m Montage: auf Rohr, kabel 1 m монтаж: трубка, кабель 1 м 	03.0557.0000
727159 LEVÁ / LEFT / LINKS / ЛЕВАЯ			03.0558.0000



722934	12V	PY21W 12V, BAU15s
722940	12V	R5W 12V, BA15s
722935	24V	PY21W 24V, BAU15s
722941	24V	R5W 24V, BA15s

Kryt / Lens / Lichtscheibe / Крышка

727161	
--------	--

KÓD / ORDER CODE / BESTELL NR. / КОД	NEW HOLLAND: T-5000, T-5040, T-5050, T-5060 ...	POPIS / DESCRIPTION / BESCHREIBUNG / ОПИСАНИЕ	OE / OE NUMBER / OE NUMBER / OE
728390 PRAVÁ / RIGHT / RECHTS / ПРАВАЯ	 	 <ul style="list-style-type: none"> Hlavní světlomet NEW HOLLAND Head lamp NEW HOLLAND Hauptscheinwerfer NEW HOLLAND Передние фары NEW HOLLAND 	82029729, 84156844
728391 LEVÁ / LEFT / LINKS / ЛЕВАЯ			82029730, 84156845

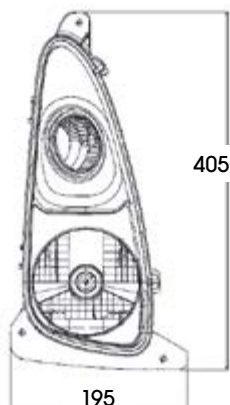

722915	12V	H4 12V, 55/60W
722956	12V	W5W 12V, W2.1x9.5d

KÓD / ORDER CODE / BESTELL NR. / КОД	NEW HOLLAND: TL 70, TL 80, TL 90, TL 100, 4636, 5635 ...	POPIS / DESCRIPTION/ BESCHREIBUNG / ОПИСАНИЕ	OE / OE NUMBER / OE NUMBER / OE
722364		<p>E</p> <ul style="list-style-type: none"> ■ Hlavní světlomet NEW HOLLAND ■ Head lamp NEW HOLLAND ■ Hauptschein werfer NEW HOLLAND ■ Передние фары NEW HOLLAND 	5165824

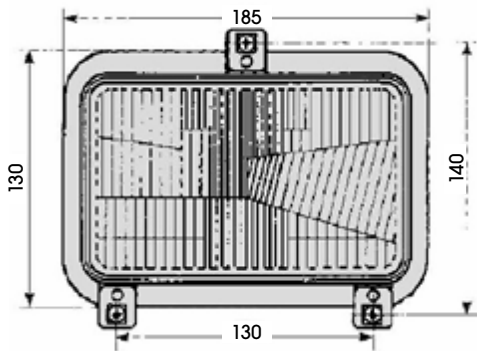

722915	12V	H4 12V, 55/60W
722916	24V	H4 24V, 70/75W

KÓD / ORDER CODE / BESTELL NR. / КОД	NEW HOLLAND: TC 27, TC 40, TD 65, TN 55, TT 55, TT 65 ...	POPIS / DESCRIPTION/ BESCHREIBUNG / ОПИСАНИЕ	OE / OE NUMBER / OE NUMBER / OE
722365		<p>E</p> <ul style="list-style-type: none"> ■ Hlavní světlomet NEW HOLLAND ■ Head lamp NEW HOLLAND ■ Hauptschein werfer NEW HOLLAND ■ Передние фары NEW HOLLAND 	5173676 5177846

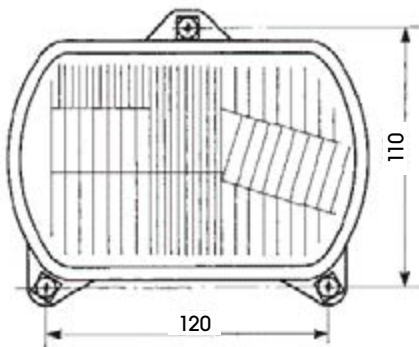

722915	12V	H4 12V, 55/60W
722916	24V	H4 24V, 70/75W

KÓD / ORDER CODE / BESTELL NR. / КОД	NEW HOLLAND: 8670, 8770, 8870A, 8670A, 8870A, 8970A, ...	POPIS / DESCRIPTION / BESCHREIBUNG / ОПИСАНИЕ	OE / OE NUMBER / OE NUMBER / OE
722366	 	<p></p> <ul style="list-style-type: none"> ■ Hlavní světlomet NEW HOLLAND ■ Head lamp NEW HOLLAND ■ Hauptscheinwerfer NEW HOLLAND ■ Передние фары NEW HOLLAND 	05.376.000.01

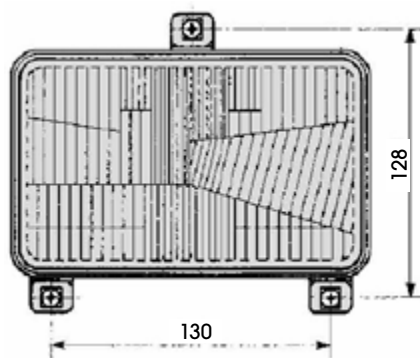

722915	12V	H4 12V, 55/60W
722916	24V	H4 24V, 70/75W

PRŮCHODKA, UCHYCENÍ VE TVARU U / GROMMET PG, U-SHAPED BASE /
VERSCHRAUBUNG, BEFESTIGUNGSBÜGEL-U / ПРОКЛАДКА, КРЕПЛЕНИЕ В ВИДЕ U

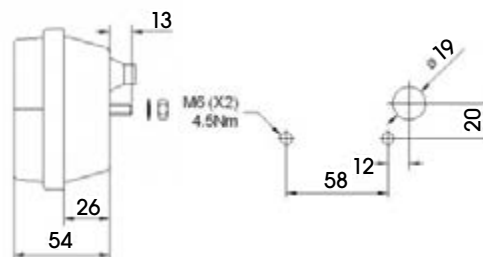

KÓD / ORDER CODE / BESTELL NR. / КОД	OE / OE NUMBER / OE NUMBER / OE	PRAVÁ / RIGHT / RECHTS / ПРАВАЯ	LEVÁ / LEFT / LINKS / ЛЕВАЯ	OSVĚTLENÍ SPZ / ILLUMINATION FOR NUMBERPLATE / KENNZEICHENLEUCHTE / ПОДСВЕТКА НОМЕРНОГО ЗНАКА	PŘIPOJENÍ / CONNECTION / ANSCHLUSS / СОЕДИНЕНИЕ	
722817	02.728.000.01	■	■			
722818 KRYT / LENS / LICHTSCHEIBE / КРЫШКА		■	■			
				722937	12V	P21 5W 12V, BAY15d
				722931	12V	P21W 12V, BA15s
				722938	24V	P21 5W 24V, BAY15d
				722932	24V	P21W 24V, BA15s



**2 KOMOROVÉ KONCOVÉ - BRZDOVÉ - SMĚROVÉ / 2-CHAMBER LIGHT TAIL - STOP - FLASHER LAMP /
2-KAMMER LEUCHE SCHLUSS - BREMS - BLINKLEUCHE /
2-ФУНКЦИОНАЛЬНАЯ ЗАДНЯЯ ФАРА-ЛАМПА СИГНАЛА СТОП, ТОРМАЖЕНИЯ-УКАЗАТЕЛЬ ПОВОРОТА**

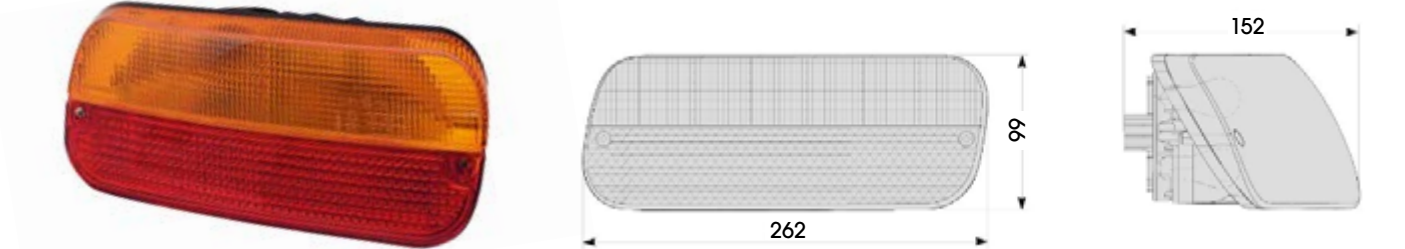

KÓD / ORDER CODE / BESTELL NR. / КОД	OE / OE NUMBER / OE NUMMER / OE	PRAVÁ / RIGHT / RECHTS / ПРАВАЯ	LEVÁ / LEFT / LINKS / ЛЕВАЯ	OSVĚTLENÍ SPZ / ILLUMINATION FOR NUMBERPLATE / KENNZEICHENLEUCHE / ПОДСВЕТКА НОМЕРНОГО ЗНАКА	PŘIPOJENÍ / CONNECTION / ANSCHLUSS / СОЕДИНЕНИЕ	
725207	02.1000.0000	■				
725202	02.0999.0000		■			
725206 - KRYT / LENS / LICHTSCHEIBE / КРЫШКА	02.1340.0200	■				
725205 - KRYT / LENS / LICHTSCHEIBE / КРЫШКА	02.1339.0200		■			
				722934	12 V	PY21W 12V, BAU15s
				722937	12 V	P21 5W 12V, BAY15d
				722935	24 V	P21W 24V, BA15s
				722938	24 V	P21 5W 24V, BAY15d



**2 KOMOROVÉ KONCOVÉ - BRZDOVÉ - SMĚROVÉ / 2-CHAMBER LIGHT TAIL - STOP - FLASHER LAMP /
2-KAMMER LEUCHE SCHLUSS - BREMS - BLINKLEUCHE /
2-ФУНКЦИОНАЛЬНАЯ ЗАДНЯЯ ФАРА-ЛАМПА СИГНАЛА СТОП, ТОРМАЖЕНИЯ-УКАЗАТЕЛЬ ПОВОРОТА**

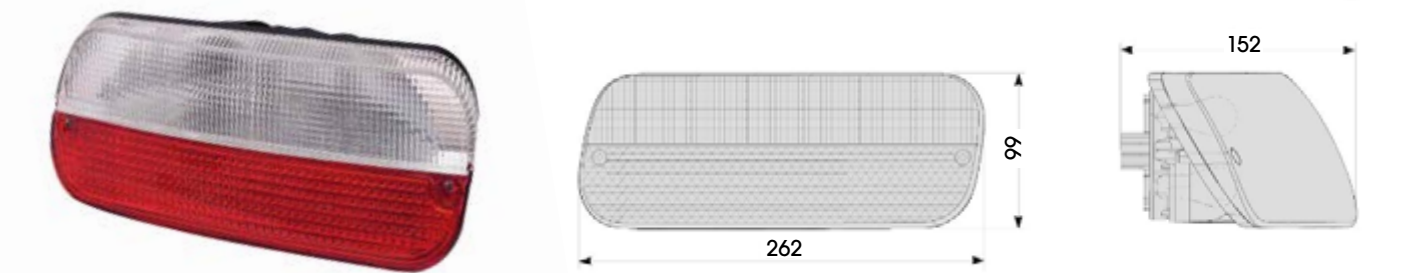

KÓD / ORDER CODE / BESTELL NR. / КОД	OE / OE NUMBER / OE NUMMER / OE	PRAVÁ / RIGHT / RECHTS / ПРАВАЯ	LEVÁ / LEFT / LINKS / ЛЕВАЯ	OSVĚTLENÍ SPZ / ILLUMINATION FOR NUMBERPLATE / KENNZEICHENLEUCHE / ПОДСВЕТКА НОМЕРНОГО ЗНАКА	PŘIPOJENÍ / CONNECTION / ANSCHLUSS / СОЕДИНЕНИЕ	
725208	02.1157.0000	■				
725203	02.1156.0000		■			
725210 - KRYT / LENS / LICHTSCHEIBE / КРЫШКА	02.1157.0200	■				
725209 - KRYT / LENS / LICHTSCHEIBE / КРЫШКА	02.1156.0200		■			
				722934	12 V	PY21W 12V, BAU15s
				722937	12 V	P21 5W 12V, BAY15d
				722935	24 V	P21W 24V, BA15s
				722938	24 V	P21 5W 24V, BAY15d



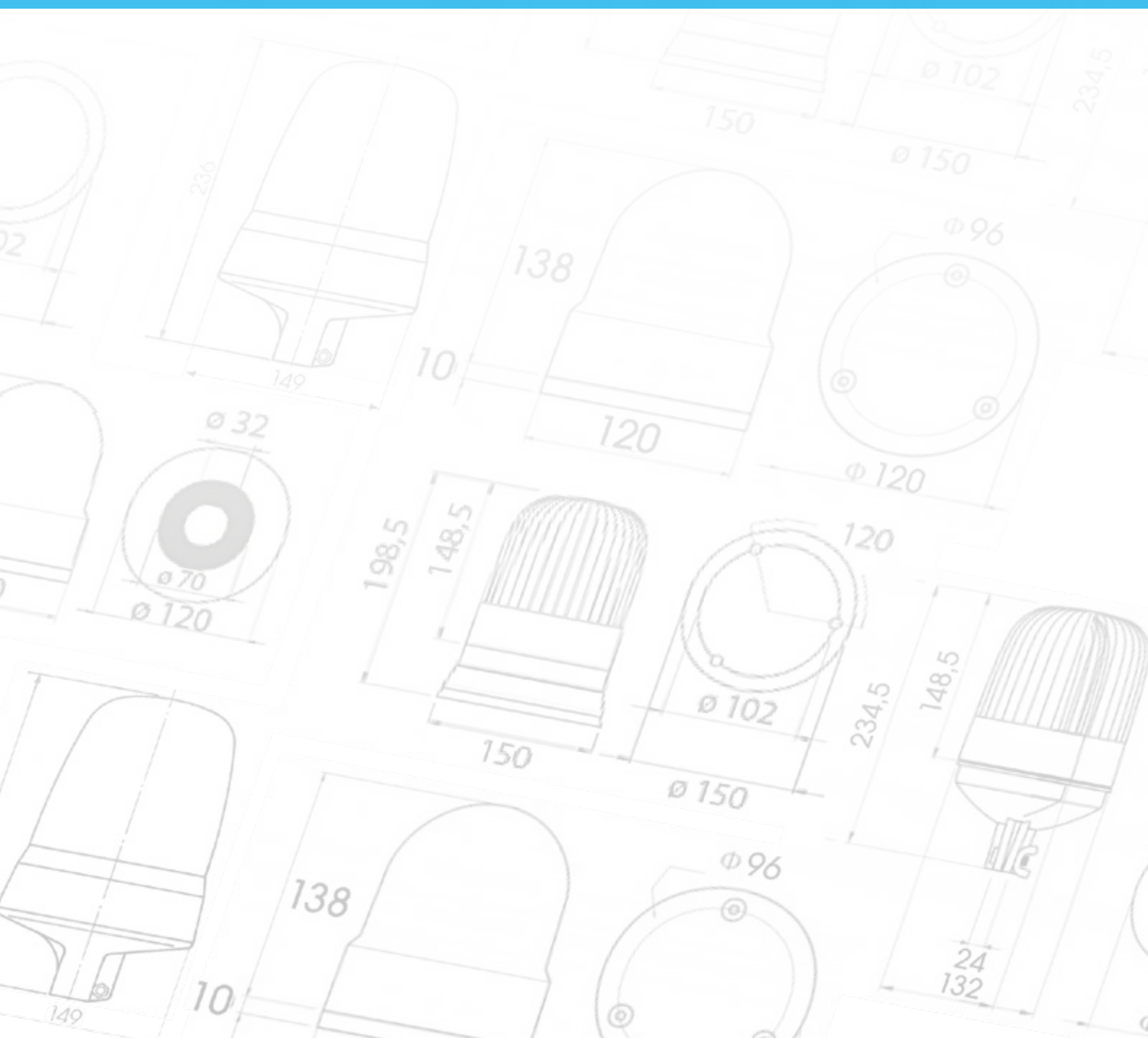





MAJÁKY /
BEACONS /
DREHKENNLEUCHTEN /
МАЯКИ /

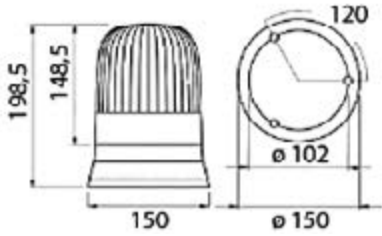

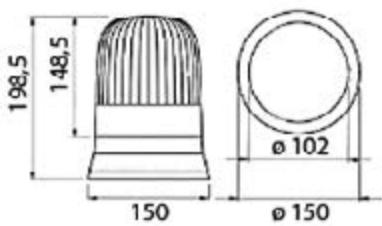

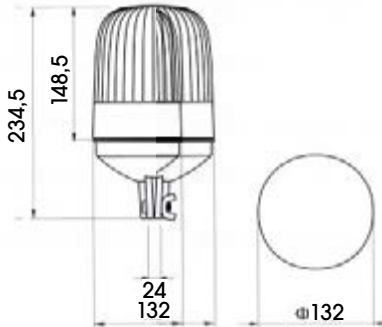

ROTAČNÍ MAJÁKY / ROTATING BEACONS / DREHNENLEUCHTENN / ВРАЩАЮЩИЕСЯ СИГНАЛЬНЫЕ МАЯКИ

KÓD / ORDER CODE / BESTELL NR. / КОД	POPIS / DESCRIPTION/ BESCHREIBUNG / ОПИСАНИЕ	OE / OE NUMBER / OE NUMMER / OE	NÁKRES / DRAWING / ZEICHNUNG / ЧЕРТЁЖ
727192 / 12V 727193 / 24V	<p>ECE R65 E</p> <ul style="list-style-type: none"> Upevnění - 3x šrouby Fixing - 3x screws Befestigung - 3x Schrauben Крепление - 3 винта 		
727195 / 12V 727196 / 24V	<p>ECE R65 E</p> <ul style="list-style-type: none"> Upevnění - magnet, kabel - 3 m Fixing - magnetic base, cable - 3 m Befestigung - magnet, kabel - 3 m Крепление - магнит, длина провода - 3 метра 		
727197 / 12V 727198 / 24V	<p>ECE R65 E</p> <ul style="list-style-type: none"> Upevnění - tyč Fixing - for mounting bushes Befestigung - für Befestigungsstutzen Крепление - стержень 		
		722931 722932	12V 24V P21W 12V, BA15s P21W 24V, BA15s
Kryt majáku / Lens / Lichtscheibe / Крышка маяка			
727191			





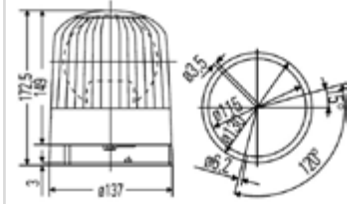

ROTAČNÍ MAJÁKY / ROTATING BEACONS / DREHKENNLEUCHTEN / ВРАЩАЮЩИЕСЯ СИГНАЛЬНЫЕ МАЯКИ

KÓD / ORDER CODE / BESTELL NR. / КОД		POPIS / DESCRIPTION/ BESCHREIBUNG / ОПИСАНИЕ	OE / OE NUMBER / OE NUMMER / OE	NÁKRES / DRAWING / ZEICHNUNG / ЧЕРТЁЖ
720002 / 12V 720003 / 24V		<p>ECE R65 E</p> <ul style="list-style-type: none"> Upevnění - 3x šrouby Fixing - 3x screws Befestigung - 3x Schrauben Крепление - 3 винта 		
720007 / 12V 720008 / 24V		<p>ECE R65 E</p> <ul style="list-style-type: none"> Upevnění - magnet, kabel - 3 m Fixing - magnetic base, cable - 3 m Befestigung - magnet, kabel - 3 m Крепление - магнит, длина провода - 3 метра 		
720025 / 12V 720026 / 24V		<p>ECE R65 E</p> <ul style="list-style-type: none"> Upevnění - tyč Fixing - for mounting bushes Befestigung - für Befestigungsstutzen Крепление - стержень 		
			<p>722909 12V H3 12V 55W, PK22s</p> <p>722910 24V H3 24V 70W, PK22s</p>	
Kryt majáku / Lens / Lichtscheibe / Крышка маяка				
	720009			
	720024			
	720054			

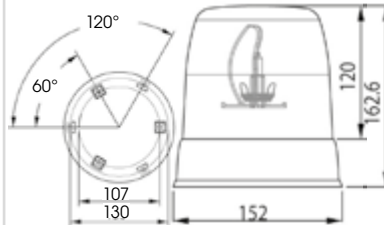
ROTAČNÍ MAJÁKY / ROTATING BEACONS / DREHKENNLEUCHTENN / ВРАЩАЮЩИЕСЯ СИГНАЛЬНЫЕ МАЯКИ

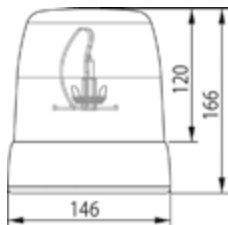
KÓD / ORDER CODE / BESTELL NR. / КОД		POPIS / DESCRIPTION/ BESCHREIBUNG / ОПИСАНИЕ	OE / OE NUMBER / OE NUMBER / OE	NÁKRES / DRAWING / ZEICHNUNG / ЧЕРТЁЖ
721115	 	<p>IP 54 E 24V</p> <ul style="list-style-type: none"> Upevnění - 3x šrouby Fixing - 3x screws Befestigung - 3x Schrauben Крепление - 3 винта 	2RL004958-111	
			722901	24V H1 24V 70W, P14,5s
Kryt majáku / Lens / Lichtscheibe / Крышка маяка				
■ 721111				
721120	 	<p>IP 54 R65 E 24V</p> <ul style="list-style-type: none"> Upevnění - 3x šrouby Fixing - 3x screws Befestigung - 3x Schrauben Крепление - 3 винта 	2RL007550-021	
721121	 	<p>IP 54 R65 E 24V</p> <ul style="list-style-type: none"> Upevnění - magnet, kabel - 3m Fixing - magnetic base, cable - 3m Befestigung - magnet, kabel - 3m Укрепление - магнит. Длина провода - 3 метра 	2RL007550-021	
721122	 	<p>IP 54 R65 E 24V</p> <ul style="list-style-type: none"> Upevnění - tyč Fixing - for mounting bushes Befestigung - für Befestigungsstutzen Крепление - стержень 	2RL007553-021	
			722900 722901	12V 24V H1 12V 55W, P14,5s H1 24V 70W, P14,5s
Kryt majáku / Lens / Lichtscheibe / Крышка маяка				
■ 721123				

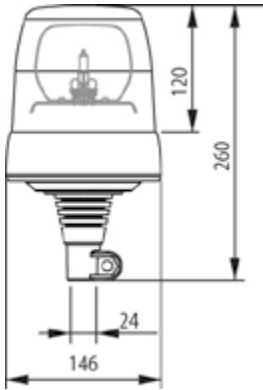
ROTAČNÍ MAJÁKY / ROTATING BEACONS / DRENKENNLEUCHTEN / ВРАЩАЮЩИЕСЯ СИГНАЛЬНЫЕ МАЯКИ









KÓD / ORDER CODE / BESTELL NR. / КОД		POPIS / DESCRIPTION/ BESCHREIBUNG / ОПИСАНИЕ	OE / OE NUMBER / OE NUMBER / OE	NÁKRES / DRAWING / ZEICHNUNG / ЧЕРТЁЖ
726890		<p>ECE R65 E 12V 24V</p> <ul style="list-style-type: none"> Upevnění - 3x šrouby Fixing - 3x screws Befestigung - 3x Schrauben Крепление - 3 винта 		
726891		<p>ECE R65 E 12V 24V</p> <ul style="list-style-type: none"> Upevnění - magnet, kabel - 3 m Fixing - magnetic base, cable - 3 m Befestigung - magnet, kabel - 3 m Крепление - магнит, длина провода - 3 метра 		
726892		<p>ECE R65 E 12V 24V</p> <ul style="list-style-type: none"> Upevnění - tyč Fixing - for mounting bushes Befestigung - für Befestigungsstutzen Крепление - стержень 		
			<p>722900 12V H1 12V 55W, P14, 5s</p> <p>722901 24V H1 24V 70W, P14, 5s</p>	

Kryt majáku / Lens / Lichtscheibe / Крышка маяка

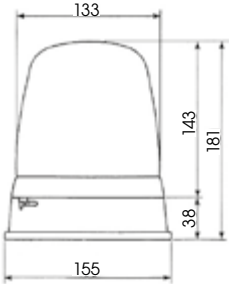

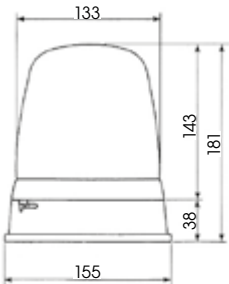

726893

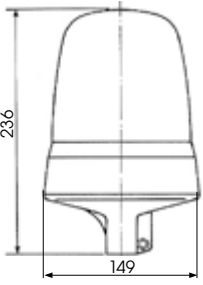

ROTAČNÍ MAJÁKY / ROTATING BEACONS / DREHKENNLEUCHTENN / ВРАЩАЮЩИЕСЯ СИГНАЛЬНЫЕ МАЯКИ

KÓD / ORDER CODE / BESTELL NR. / КОД		POPIS / DESCRIPTION/ BESCHREIBUNG / ОПИСАНИЕ	OE / OE NUMBER / OE NUMBER / OE	NÁKRES / DRAWING / ZEICHNUNG / ЧЕРТЕЖ
726875	 	<ul style="list-style-type: none"> IP 53 ECE R65 E 12V 24V <ul style="list-style-type: none"> Upevnění - 3x šrouby Fixing - 3x screws Befestigung - 3x Schrauben Крепление - 3 винта 	1031171 35.400.000.01	
720031		<ul style="list-style-type: none"> Gumová podložka pod výstražný maják slouží k variabilnímu naklonění o cca 15° výstražného majáku Rubber pad under the rotating beacon. Variable inclination od 15° rotating beacon 	<ul style="list-style-type: none"> Gummiunterlage für variable Neigung von etwa 15° Leuchtfeuer verwendet Резиновая прокладка под 15° для наклона под сигнальный маяк 	
726876	 	<ul style="list-style-type: none"> IP 53 ECE R65 E 12V 24V <ul style="list-style-type: none"> Upevnění - magnet, kabel - 3 m Fixing - magnetic base, cable - 3 m Befestigung - magnet, kabel - 3 m Крепление - магнит, длина провода - 3 метра 	1031201 35.406.000.01	
726874	 	<ul style="list-style-type: none"> IP 53 ECE R65 E 12V 24V <ul style="list-style-type: none"> Upevnění - tyč Fixing - for mounting bushes Befestigung - für Befestigungsstutzen Крепление - стержень 	35.404.000.01	

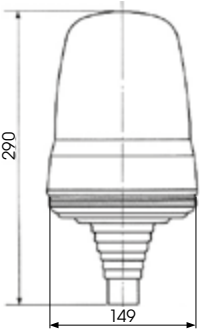
ROTAČNÍ MAJÁKY / ROTATING BEACONS / DRENNENLEUCHTEN / ВРАЩАЮЩИЕСЯ СИГНАЛЬНЫЕ МАЯКИ





KÓD / ORDER CODE / BESTELL NR. / КОД	POPIS / DESCRIPTION / BESCHREIBUNG / ОПИСАНИЕ	OE / OE NUMBER / OE NUMBER / OE	NÁKRES / DRAWING / ZEICHNUNG / ЧЕРТЁЖ
726878	  <p> IP 53 ECE R65 E 12V 24V </p> <ul style="list-style-type: none"> Upevnění - tyč Fixing - for mounting bushes Befestigung - für Befestigungsstutzen Крепление - стержень 	35.408.000.01	
		722900 722901	12V H1 12V 55W, P14, 5s 24V H1 24V 70W, P14, 5s

Kryt majáku / Lens / Lichtscheibe / Крышка маяка

726877	
724859	
724858	

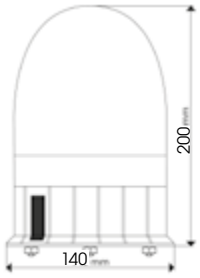

LED 12-24V MAJÁKY / LED 12-24V WARNING BEACONS /
LED 12-24V KENNLEUCHTEN / Светодиодные 12-24 V маяки

KÓD / ORDER CODE / BESTELL NR. / КОД		POPIS / DESCRIPTION/ BESCHREIBUNG / ОПИСАНИЕ	OE / OE NUMBER / OE NUMBER / OE	NÁKRES / DRAWING / ZEICHNUNG / ЧЕРТЁЖ
727430	 	<p>9-33V IP 56 EMC LED E</p> <p>-30°C to + 50°C, 80x LED</p> <ul style="list-style-type: none"> Upevnění třemi šrouby (možnost přepínání světelných funkcí - blikající nebo otočná) Fixing - 3x screws (the ability to switch light functions - flashing or rotating) Befestigung - 3x Schrauben (die Fähigkeit, Lichtfunktionen zu wechseln - blinkend oder Drehen) Крепление с помощью 3 винтов (Возможности - переключение функций: мигание или вращение) 		
727431	 	<p>9-33V IP 56 EMC LED E</p> <p>-30°C to + 50°C, 80x LED</p> <ul style="list-style-type: none"> Upevnění na magnet (možnost přepínání světelných funkcí - blikající nebo otočná, pracovní délka kabelu- 2,5 m) Fixing - magnetic base (the ability to switch light functions - flashing or rotating, cable - 2,5 m) Befestigung - Magnet (die Fähigkeit, Lichtfunktionen zu wechseln - blinkend oder Drehen kabel - 2,5 m) Крепление - магнит, длина провода (Возможности - переключение функций: мигание или вращение 2,5 метра) 		
727433	 	<p>9-33V IP 56 EMC LED E</p> <p>-30°C to + 50°C, 80x LED</p> <ul style="list-style-type: none"> Upevnění na tyč (možnost přepínání světelných funkcí - blikající nebo otočná) Fixing - for mounting bushes (the ability to switch light functions - flashing or rotating) Befestigung - für Befestigungsstutzen (die Fähigkeit, Lichtfunktionen zu wechseln - blinkend oder) Крепление на стержень (Возможности - переключение функций: мигание или вращение) 		



LED 12-24V MAJÁKY / LED 12-24V WARNING BEACONS / LED 12-24V KENNLEUCHTEN / Светодиодные 12-24 V маяки

KÓD / ORDER CODE / BESTELL NR. / КОД		POPIS / DESCRIPTION/ BESCHREIBUNG / ОПИСАНИЕ	OE / OE NUMBER / OE NUMBER / OE	NÁKRES / DRAWING / ZEICHNUNG / ЧЕРТЁЖ
727432	 	<p>9-33V IP 56 EMC LED E</p> <p>-30°C to + 50°C, 80x LED</p> <ul style="list-style-type: none"> Upevnění - tyč (možnost přepínání světelných funkcí - blikající nebo otočná) Fixing - for mounting bushes, flexible mounting (the ability to switch light functions - flashing or rotating) Befestigung - für Befestigungsstutzen, Flexible Halterung (die Fähigkeit, Lichtfunktionen zu wechseln - blinkend oder) Укрепление - стержень (Возможности - переключение функций: мигание или вращение) 		





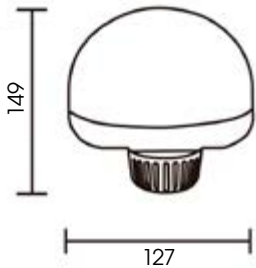

Kryt majáku / Lens / Lichtscheibe / Крышка маяка

727434

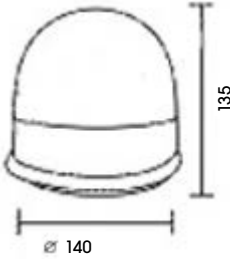

KÓD / ORDER CODE / BESTELL NR. / КОД		POPIS / DESCRIPTION/ BESCHREIBUNG / ОПИСАНИЕ	OE / OE NUMBER / OE NUMBER / OE	NÁKRES / DRAWING / ZEICHNUNG / ЧЕРТЁЖ
726008	 	<p>9-33V IP 56 ECE 65 LED</p> <p>-30°C to + 50°C, 40X LED</p> <ul style="list-style-type: none"> Upevnění - tyč (možnost přepínání světelných funkcí - blikající nebo otočná) Fixing - for mounting bushes, Flexible mounting (the ability to switch light functions - flashing or rotating) Befestigung - Für Befestigungsstutzen, Flexible Halterung (die Fähigkeit, Lichtfunktionen zu wechseln - blinkend oder Drehen) Укрепление - стержень. (Возможности - переключение функций: мигание или вращение) 		

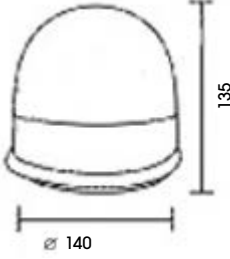
LED 12-24V VÝSTRAŽNÉ MAJÁKY / LED 12-24V WARNING BEACONS /
LED 12-24V KENNLEUCHTEN / Светодиодные 12-24 V маяки







KÓD / ORDER CODE / BESTELL NR. / КОД		POPIS / DESCRIPTION/ BESCHREIBUNG / ОПИСАНИЕ	OE / OE NUMBER / OE NUMBER / OE	NÁKRES / DRAWING / ZEICHNUNG / ЧЕРТЕЖ
727450	 	9-33V IP 56 ECE 65 LED 8X LED <ul style="list-style-type: none"> Upevnění - 3x šrouby (možnost přepínání světelných funkcí - blikající nebo otočná) Fixing - 3x screws (the ability to switch light functions - flashing or rotating) Befestigung - 3x Schrauben (die Fähigkeit, Lichtfunktionen zu wechseln - blinkend oder Drehen) Укрепление с помощью 3 винтов (Возможности - переключение функций: мигание или вращение) 		
727446	 	9-33V IP 56 ECE 65 LED 8X LED <ul style="list-style-type: none"> Upevnění - magnet Fixing - magnetic base Befestigung - magnet Укрепление - магнит 		
727445	 	9-33V IP 56 ECE 65 LED 8X LED <ul style="list-style-type: none"> Upevnění - tyč (možnost přepínání světelných funkcí - blikající nebo otočná) Fixing - for mounting bushes, Flexible mounting (the ability to switch light functions - flashing or rotating) Befestigung - Für Befestigungsstutzen, Flexible Halterung (die Fähigkeit, Lichtfunktionen zu wechseln - blinkend oder Drehen) Укрепление - стержень. (Возможности - переключение функций: мигание или вращение) 		

Kryt majáku / Lens / Lichtscheibe / Крышка маяка

727447



**LED 12-24V VÝSTRAŽNÉ MAJÁKY / LED 12-24V WARNING BEACONS /
LED 12-24V KENNLEUCHTEN / Светодиодные 12-24 V маяки**





KÓD / ORDER CODE / BESTELL NR. / КОД	POPIS / DESCRIPTION/ BESCHREIBUNG / ОПИСАНИЕ	OE / OE NUMBER / OE NUMMER / OE	NÁKRES / DRAWING / ZEICHNUNG / ЧЕРТЁЖ
726052	<p>LUMINEX[®]</p>  <p>9-33 V R65 ECE LED E</p> <ul style="list-style-type: none"> Upevnění - 1x šroub, kabel - 0,3 m Fixing - 1x screw, cable - 0,3 m Befestigung - 1x schrauben, kabel - 0,3 m Крепление с помощью 1 винтов. Длина провода - 0,3 метра 		
726051	<p>LUMINEX[®]</p>  <p>9-33 V R65 ECE LED E</p> <ul style="list-style-type: none"> Upevnění - magnet. kabel - 7,8 m Fixing - magnetic base, cable - 7,8 m Befestigung - magnet, kabel - 7,8 m Крепление - магнит. Длина провода - 7,8 метра 		
726053	<p>LUMINEX[®]</p>  <p>9-33 V R65 ECE LED E</p> <ul style="list-style-type: none"> Upevnění - tyč Fixing - for mounting bushes Befestigung - Für Befestigungsstutzen Крепление - стержень 		

Kryt majáku / Lens / Lichtscheibe / Крышка маяка

726071

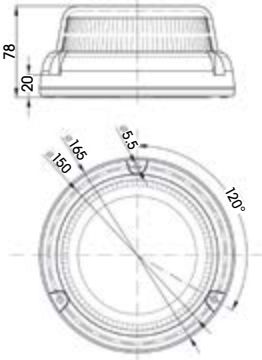

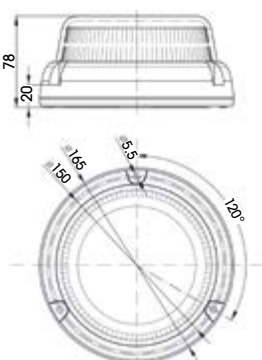
LED 12-24V VÝSTRAŽNÉ MAJÁKY / LED 12-24V WARNING BEACONS / LED 12-24V KENNLEUCHTEN / Светодиодные 12-24 V маяки

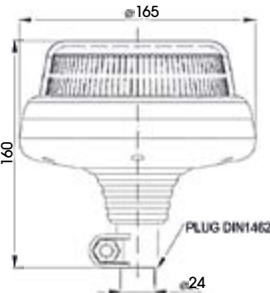
KÓD / ORDER CODE / BESTELL NR. / КОД		POPIS / DESCRIPTION/ BESCHREIBUNG / ОПИСАНИЕ	OE / OE NUMBER / OE NUMBER / OE	NÁKRES / DRAWING / ZEICHNUNG / ЧЕРТЁЖ
726047		<p> 9-33 V IP 68 ECE 65 EMC LED E </p> <p>20X LED, od -40 °C do +55 °C</p> <ul style="list-style-type: none"> Upevnění - 3x šrouby, kabel - 1,5 m, dvojzáblesk Fixing - 3x screws, cable - 1,5 m, double flash Befestigung - 3x Schrauben, kabel - 1,5 m, doppelten Blitz Крепление с помощью 3 винтов. Длина провода - 1,5 метра, с двойной вспышкой 		
726057		<p> 9-33 V IP 68 ECE 65 EMC LED E </p> <p>20X LED, od -40 °C do +55 °C</p> <ul style="list-style-type: none"> Upevnění - magnet, kabel - 7,8 m, dvojzáblesk Fixing - magnetic base, kabel - 7,8 m, double flash Befestigung - magnet, kabel - 7,8 m, doppelten Blitz Укрепление - магнит. Длина провода - 7,8 метра, с двойной вспышкой 		
726070		<p> 9-33 V IP 68 ECE 65 EMC LED E </p> <p>20X LED, od -40 °C do +55 °C</p> <ul style="list-style-type: none"> Upevnění - tyč, dvojzáblesk Fixing - for mounting bushes, double flash Befestigung - Für Befestigungsstutzen, doppelten Blitz Крепление - стержень, с двойной вспышкой 		

LED 12-24V MAJÁKY / LED 12-24V WARNING BEACONS / LED 12-24V KENNLEUCHTEN / Светодиодные 12-24 V маяки

KÓD / ORDER CODE / BESTELL NR. / КОД		POPIS / DESCRIPTION/ BESCHREIBUNG / ОПИСАНИЕ	OE / OE NUMBER / OE NUMBER / OE	NÁKRES / DRAWING / ZEICHNUNG / ЧЕРТЁЖ
723659		<p>9-33V EMC LED E</p> <p>-30°C to + 50°C, 6x LED</p> <ul style="list-style-type: none"> ■ Upevnění - 3x šrouby ■ Fixing - 3x screws ■ Befestigung - 3x Schrauben ■ Крепление с помощью 3 винтов 	B90.00.LMV	
723660		<p>9-33V EMC LED E</p> <p>-30°C to + 50°C, 6x LED</p> <ul style="list-style-type: none"> ■ Upevnění - magnet, kabel - 2,5 m ■ Fixing - magnetic base, cable - 2,5 m ■ Befestigung - magnet, kabel - 2,5 m ■ Крепление - магнит Длина провода - 2,5 метра 	B94.70.LMV	
723661		<p>9-33V EMC LED E</p> <p>-30°C to + 50°C, 6x LED</p> <ul style="list-style-type: none"> ■ Upevnění - tyč ■ Fixing - for mounting bushes ■ Befestigung - Für Befestigungsstutzen ■ Крепление - стержень 	B92.00.LMV	
723662		<p>9-33V EMC LED E</p> <p>-30°C to + 50°C, 6x LED</p> <ul style="list-style-type: none"> ■ Upevnění - tyč ■ Fixing - for mounting bushes ■ Befestigung - Für Befestigungsstutzen ■ Крепление - стержень 	B95.00.LMV	









Kryt majáku / Lens / Lichtscheibe / Крышка маяка

■ 726877

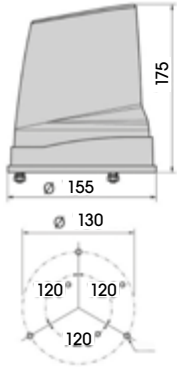
■ 724859

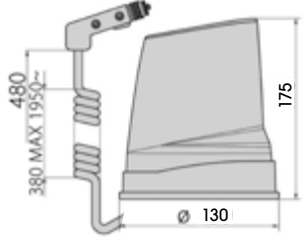
■ 724858

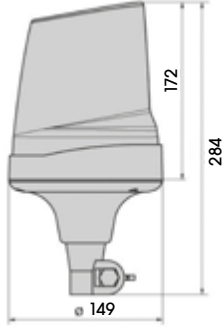
XENON 12-24V VÝSTRAŽNÉ MAJÁKY / XENON 12-24V WARNING BEACONS / XENON 12-24V KENNLEUCHTEN / КСЕНОНОВЫЕ 12-24 V МАЯКИ

KÓD / ORDER CODE / BESTELL NR. / КОД		POPIS / DESCRIPTION / BESCHREIBUNG / ОПИСАНИЕ	OE / OE NUMBER / OE NUMBER / OE	NÁKRES / DRAWING / ZEICHNUNG / ЧЕРТЁЖ
727390	 	<p>9-33V IP 54 EMC R65 E</p> <ul style="list-style-type: none"> Upevnění - 3x šrouby Fixing - 3x screws Befestigung - 3x schrauben Крепление - 3 болта 	5.7006.0000.01	
727391	 	<p>9-33V IP 54 EMC R65 E</p> <ul style="list-style-type: none"> Upevnění - magnet Fixing - magnetic base Befestigung - magnet Крепление - магнит 	5.7010.0000.01	
727388	 	<p>9-33V IP 54 EMC R65 E</p> <ul style="list-style-type: none"> Upevnění - tyč, pružné uchycení Fixing - for mounting bushes, flexible mounting Befestigung - Für Befestigungsstutzen Flexible Halterung Крепление - держак 	5.7008.0000.01	
720343		<ul style="list-style-type: none"> Xenonová výbojka Flash unit (xenon) Blitzeinhe Ксеноновая лампаит 		

Kryt majáku / Lens / Lichtscheibe / Крышка маяка







■ 727392

■ 727395

XENON 12-24V VÝSTRAŽNÉ MAJÁKY / XENON 12-24V WARNING BEACONS / XENON 12-24V KENNLEUCHTEN / КСЕНОНОВЫЕ 12-24 V МАЯКИ

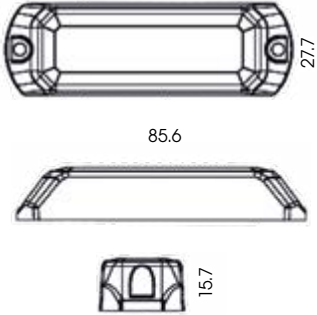
KÓD / ORDER CODE / BESTELL NR. / КОД		POPIS / DESCRIPTION / BESCHREIBUNG / ОПИСАНИЕ	OE / OE NUMBER / OE NUMBER / OE	NÁKRES / DRAWING / ZEICHNUNG / ЧЕРТЁЖ
727386		<p> 9-33V IP 6X IP X7  </p> <p>-25°C to +65°C, 80x LED</p> <ul style="list-style-type: none"> ■ Upevnění - 2x šrouby, kabel 5 m ■ Fixing - 2x screws, cable 5 m ■ Befestigung - 2x Schrauben, kabel 5 m ■ Крепление с помощью 2 винтов. Длина провода - 5 метров 		
727387		<p> 9-33V IP 6X IP X7  </p> <p>-25°C to +65°C, 80x LED</p> <ul style="list-style-type: none"> ■ Upevnění - 2x šrouby, kabel 5 m ■ Fixing - 2x screws, cable 5 m ■ Befestigung - 2x Schrauben, kabel 5 m ■ Крепление с помощью 2 винтов. Длина провода - 5 метров 		
729315		<p> 9-33V IP 6X IP X7  </p> <ul style="list-style-type: none"> ■ Upevnění - tyč ■ Fixing - for mounting bushes ■ Befestigung - Für Befestigungsstutzen ■ Крепление - стержень 		

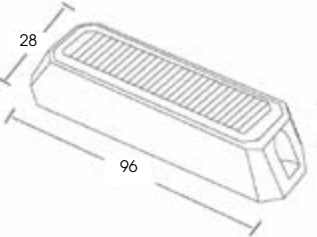
LED VÝSTRAŽNÁ SVĚTLA / LED FLASHING LAMPS / LED BLITZLEUCHTEN / СВЕТОДИОДНЫЕ СИГНАЛЬНАЯ ЛАМПА

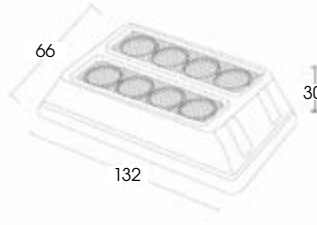
KÓD / ORDER CODE / BESTELL NR. / КОД		POPIS / DESCRIPTION/ BESCHREIBUNG / ОПИСАНИЕ	OE / OE NUMBER / OE NUMBER / OE	NÁKRES / DRAWING / ZEICHNUNG / ЧЕРТЁЖ
727451	 	<p>9-33V EMC IP 67 LED E</p> <p>3x LED, 9W</p> <ul style="list-style-type: none"> ■ Světlo oranžové, 3 kabely pro 14 módů nastavení, s pamětí ■ Amber light, 3 cables for 14 modes setting With memory ■ Gelbes Licht, 3 Kabel für 14 Moduseinstellung Mit Gedächtnis ■ Огонь оранжевый, 3 проводов для 14 режимов настройки в памяти 		
727452	 	<p>9-33V EMC IP 67 LED E</p> <p>4xLED, 9W</p> <ul style="list-style-type: none"> ■ Světlo oranžové, 3 kabely pro 14 módů nastavení s pamětí ■ Amber light, 3 cables for 14 modes setting With memory ■ Gelbes Licht, 3 kabel für 14 Moduseinstellung Mit Gedächtnis ■ Огонь оранжевый, 3 проводов для 14 режимов настройки в памяти 		
727453	 	<p>9-33V EMC IP 67 LED E</p> <p>8x LED, 9W</p> <ul style="list-style-type: none"> ■ Světlo oranžové, 3 kabely pro 14 módů nastavení ■ Amber light, 3 cables for 14 modes setting ■ Gelbes Licht, 3 Kabel für 14 Moduseinstellung ■ Огонь светло - оранжевый, 3 провода для 14 режимов настройки 		

LED VÝSTRAŽNÁ SVĚTLA / LED FLASHING LAMPS / LED BLITZLEUCHTEN / СВЕТОДИОДНЫЕ СИГНАЛЬНАЯ ЛАМПА



KÓD / ORDER CODE / BESTELL NR. / КОД	POPIS / DESCRIPTION/ BESCHREIBUNG / ОПИСАНИЕ	NÁKRES / DRAWING / ZEICHNUNG / ЧЕРТЁЖ
726097	<ul style="list-style-type: none"> ■ Světlo oranžové, 6x LED modul, 7 druhů záblesků, kabel - 3,5 m, přepínač ■ Amber light, 6x LED module, 7 kinds optinions of flashes, cable - 3,5 m, switch ■ Gelbes Licht, 6x LED modul, 7 Arten von Blitzen, kabel - 3,5 m, schalter ■ ветло – оранжевое, 6x светодиодный модуль, 7 видов вспышек, кабель - 3,5 м, переключатель 	690 mm



KÓD / ORDER CODE / BESTELL NR. / КОД	POPIS / DESCRIPTION/ BESCHREIBUNG / ОПИСАНИЕ	NÁKRES / DRAWING / ZEICHNUNG / ЧЕРТЁЖ
726098	<ul style="list-style-type: none"> ■ Světlo oranžové, 7x LED modul, 7 druhů záblesků, kabel - 3,5 m, přepínač ■ Amber light, 7x LED module, 7 kinds optinions of flashes, cable - 3,5 m, switch ■ Gelbes Licht, 7x LED modul, 7 Arten von Blitzen, kabel - 3,5 m, schalter ■ ветло – оранжевое, 7x светодиодный модуль, 7 видов вспышек, кабель - 3,5 м, переключатель 	800 mm



KÓD / ORDER CODE / BESTELL NR. / КОД	POPIS / DESCRIPTION/ BESCHREIBUNG / ОПИСАНИЕ	NÁKRES / DRAWING / ZEICHNUNG / ЧЕРТЁЖ
726099	<ul style="list-style-type: none"> ■ Světlo oranžové, 8x LED modul, 7 druhů záblesků, kabel - 3,5 m, přepínač ■ Amber light, 8x LED module, 7 kinds optinions of flashes, cable - 3,5 m, switch ■ Gelbes Licht, 8x LED modul, 7 Arten von Blitzen, kabel - 3,5 m, schalter ■ ветло – оранжевое, 8x светодиодный модуль, 7 видов вспышек, кабель - 3,5 м, переключатель 	910 mm

LED RAMPY VÝSTRAŽNÝCH MAJÁKŮ / LED LIGHTBARS / LED LEUCHTBALKEN MIT BLITZLEUCHTEN / СВЕТОДИОДНЫХ ПАНДУСЫ МАЯЧКОВ РЕДУПРЕЖДЕНИЯ

LUMINEX
line

9-33 V

ECE

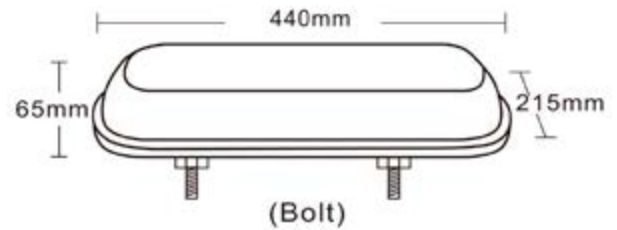

KÓD / ORDER CODE / BESTELL NR. / КОД	POPIS / DESCRIPTION/ BESCHREIBUNG / ОПИСАНИЕ
726111	<p>44x LED</p> <ul style="list-style-type: none"> Upevnění - 2x šrouby, 8 světelných funkcí, kabel - 0,3 m Fixing - 2x screws, 8 light functions, cable - 0,3 m Befestigung - 2x Schrauben, 8 Lichtfunktionen, kabel - 0,3 m Крепление - 2 винта, 8 функций освещения, Длина провода - 0,3 метра

LUMINEX
line

9-33 V

ECE

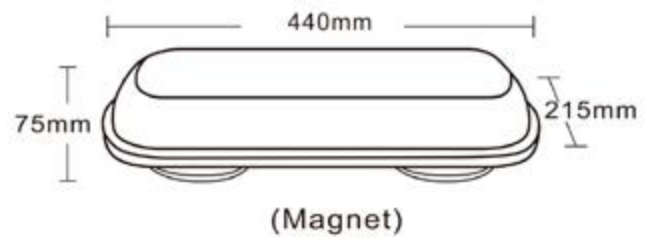

KÓD / ORDER CODE / BESTELL NR. / КОД	POPIS / DESCRIPTION/ BESCHREIBUNG / ОПИСАНИЕ
726110	<p>44x LED</p> <ul style="list-style-type: none"> Upevnění - magnet, 8 světelných funkcí, kabel - 3 m Fixing - magnetic base, 8 light functions, cable - 3 m Befestigung - magnet, 8 Lichtfunktionen, kabel - 3 m Крепление - магнит, 8 функций освещения, Длина провода - 3 метра

LED RAMPY VÝSTRAŽNÝCH MAJÁKŮ / LED LIGHTBARS / LED LEUCHTBALKEN MIT BLITZLEUCHTEN / СВЕТОДИОДНЫХ ПАНДУСЫ МАЯЧКОВ РЕДУПРЕЖДЕНИЯ

LUMINEX[®]
lima

9-33 V

R65

ECE

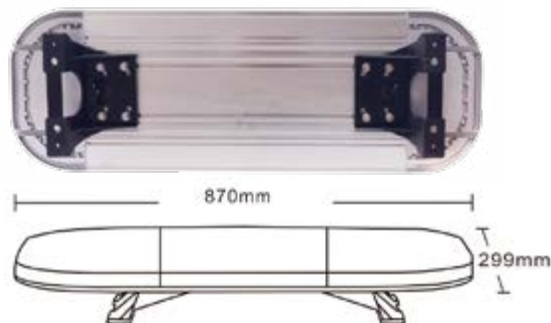

KÓD / ORDER CODE / BESTELL NR. / КОД	POPIS / DESCRIPTION/ BESCHREIBUNG / ОПИСАНИЕ	
726101	<p>102x LED</p> <ul style="list-style-type: none"> ■ Pevné uchycení pomocí držáků, 17 světelných funkcí, ovládací panel ■ Holders ensuring secure grip, 17 light functions, remote control ■ Halteren gewährleisten sicheren Halt, 17 Lichtfunktionen, fernbedienung ■ Фиксированный монтаж с помощью кронштейнов, 17 функций освещения, дистанционное управление 	

LUMINEX[®]
lima

9-33 V

R65

ECE

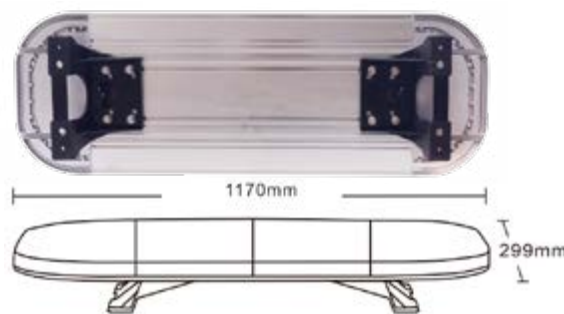

KÓD / ORDER CODE / BESTELL NR. / КОД	POPIS / DESCRIPTION/ BESCHREIBUNG / ОПИСАНИЕ	
726102	<p>132x LED</p> <ul style="list-style-type: none"> ■ Pevné uchycení pomocí držáků, 17 světelných funkcí, ovládací panel ■ Holders ensuring secure grip, 17 light functions, remote control ■ Halteren gewährleisten sicheren Halt, 17 Lichtfunktionen, fernbedienung ■ Фиксированный монтаж с помощью кронштейнов, 17 функций освещения, дистанционное управление 	

LED RAMPY VÝSTRAŽNÝCH MAJÁKŮ / LED LIGHTBARS / LED LEUCHTBALKEN MIT BLITZLEUCHTEN / СВЕТОДИОДНЫХ ПАНДУСЫ МАЯЧКОВ РЕДУПРЕЖДЕНИЯ

LUMINEX[®]
light

9-33 V

R65

ECE

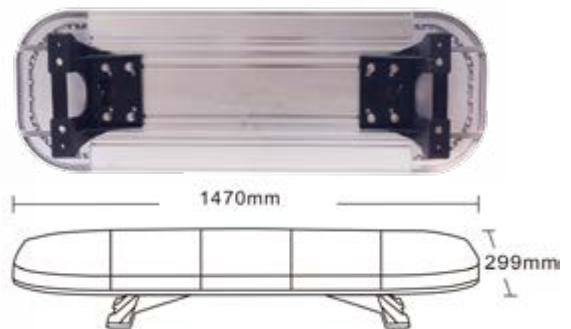

KÓD / ORDER CODE / BESTELL NR. / КОД	POPIS / DESCRIPTION/ BESCHREIBUNG / ОПИСАНИЕ	
726103	<p>162x LED</p> <ul style="list-style-type: none"> ■ Pevné uchycení pomocí držáků, 17 světelných funkcí, ovládací panel ■ Holders ensuring secure grip, 17 light functions, remote control ■ Halteren gewährleisten sicheren Halt, 17 Lichtfunktionen, fernbedienung ■ Фиксированный монтаж с помощью кронштейнов, 17 функций освещения, дистанционное управление 	

LUMINEX[®]
light

9-33 V



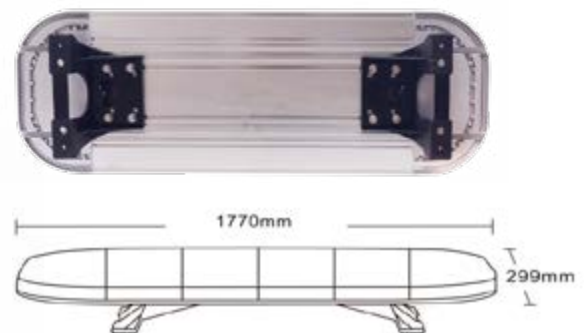

R65

ECE



KÓD / ORDER CODE / BESTELL NR. / КОД	POPIS / DESCRIPTION/ BESCHREIBUNG / ОПИСАНИЕ	
726105	<p>192x LED</p> <ul style="list-style-type: none"> ■ Pevné uchycení pomocí držáků, 17 světelných funkcí, ovládací panel ■ Holders ensuring secure grip, 17 light functions, remote control ■ Halteren gewährleisten sicheren Halt, 17 Lichtfunktionen, fernbedienung ■ Фиксированный монтаж с помощью кронштейнов, 17 функций освещения, дистанционное управление 	

BRACKETS FOR ROTATING BEACON / ДЕРЖАТЕЛИ НА МАЯКИ / HALTERUNGEN FÜR KENNLEUCHTEN / DRŽÁKY MAJÁKŮ

KÓD / ORDER CODE / BESTELL NR. / КОД		POPIS / DESCRIPTION / BESCHREIBUNG / ОПИСАНИЕ	OE / OE NUMBER / OE NUMMER / OE	NÁKRES / DRAWING / ZEICHNUNG / ЧЕРТЁЖ
720042		<ul style="list-style-type: none"> Držák na navaření s dvoupólovu zásuvkou Holder with two pole socket Halter mit zwei pologer Steckdose, Zum Anschweißen Держатель с 2 контактными разъёмами, крепление - сварка 		85 mm
720043		<ul style="list-style-type: none"> Držák s dvoupólovu zásuvkou, upevnění - na matku Holder with two pole socket, Fixing - nut Halter mit zwei pologer Steckdose, Befestigung - mutter Держатель с 2 контактными разъёмами, крепление - гайкой 		105 mm
727436		<ul style="list-style-type: none"> Držák s dvoupólovu zásuvkou - upevnění na dva šrouby Holder with two poles - fixing with two screws Halter mit zwei pologer Steckdose, Befestigung mit zwei Schrauben Держатель с 2 контактными разъёмами, крепление - 2 болтами 		120 mm
727435		<ul style="list-style-type: none"> Držák majáku (90°) s dvoupólovu zásuvkou, upevnění na dva šrouby Holder (90°) with two poles, fixing with two screws Halter (90°) mit zwei pologer Steckdose, Befestigung mit zwei Schrauben Держатель (90°) с 2 контактными разъёмами, крепление - 2 болта 		100x110 mm
727455		<ul style="list-style-type: none"> Držák majáku (90°) s dvoupólovu zásuvkou Holder (90°) with two poles Halter (90°) mit zwei pologer Steckdose Держатель (90°) с 2 контактными разъёмами 		100x150 mm

ZÁSUVKA / SOCKET / SOCKET / РАЗЪЁМ

KÓD / ORDER CODE / BESTELL NR. / КОД		POPIS / DESCRIPTION / BESCHREIBUNG / ОПИСАНИЕ	OE / OE NUMBER / OE NUMMER / OE	NÁKRES / DRAWING / ZEICHNUNG / ЧЕРТЁЖ
726775		<ul style="list-style-type: none"> ■ Dvoupólová zásuvka ■ Two pole socket ■ Zwei poles socket ■ 2 контактный разъём 		
720330		<ul style="list-style-type: none"> ■ Zástrčka, zapalovač ■ Plug, lighter ■ Stecker, feuerzeug ■ штепсельная вилка, зажигалку 		
725194		<ul style="list-style-type: none"> ■ Zásuvka, zapalovač ■ Socket, lighter ■ Zigarettanzünder Buchse ■ Цоколь, легче 		











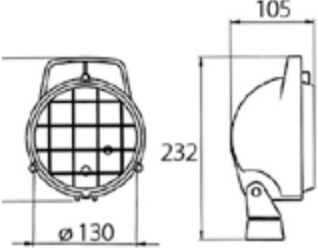

PRACOVNÍ SVĚTLOMETRY
WORK LAMPS /
ARBEITSSCHEINWERFER /
РАБОЧИЕ ЛАМПЫ/



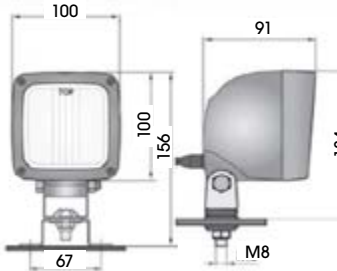



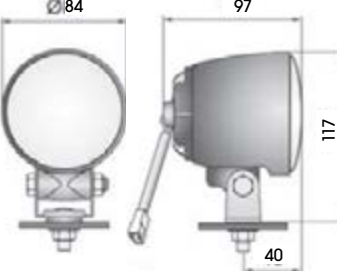



PRACOVNÍ SVĚTLOMETY / WORK LAMPS / ARBEITSSCHEINWERFER / РАБОЧИЕ ЛАМПЫ

KÓD / ORDER CODE / BESTELL NR. / КОД		POPIS / DESCRIPTION/ BESCHREIBUNG / ОПИСАНИЕ	OE / OE NUMBER / OE NUMBER / OE	NÁKRES / DRAWING / ZEICHNUNG / ЧЕРТЁЖ
720021		<p>IP 67 </p> <p>Material: Plastic</p> <ul style="list-style-type: none"> Průchodka, uchycení ve tvaru U Grommet PG, U-Shaped base Verschraubung, befestigungsbügel-U Прокладка, крепление в виде U 		
725654		<p>IP 67 </p> <p>Material: Plastic</p> <ul style="list-style-type: none"> 2 pólový konektor, uchycení: matice + šroub M8 2x poles connector, mounting: screw + nut M8 2x pole contact, montage: schraube + mutter M8 2 полюсовый конектор, крепление - гайки + болты M8 		
720224		<p>IP 68 </p> <p>Material: Plastic</p> <ul style="list-style-type: none"> 2 pólový konektor, uchycení: matice + šroub M8 2x poles connector, mounting: screw + nut M8 2x pole contact, montage: schraube + mutter M8 2 полюсовый конектор, крепление - гайки + болты M8 		
720015		<p></p> <p>Material: Plastic</p> <ul style="list-style-type: none"> Průchodka, uchycení: matice + šroub M10 Grommet, mounting: screw + nut M10 Verschraubung, montage: schraube + mutter M10 Прокладка, крепление: гайки + болты M10 		
720016		<p></p> <p>Material: Plastic</p> <ul style="list-style-type: none"> Průchodka, uchycení: matice + šroub M10 Grommet, mounting: screw + nut M10 Verschraubung, montage: schraube + mutter M10 Прокладка, крепление: гайки + болты M10 		
			<p>722909</p> <p>722910</p>	<p>12V H3 12V 55W, PK22s</p> <p>24V H3 24V 70W, PK22s</p>

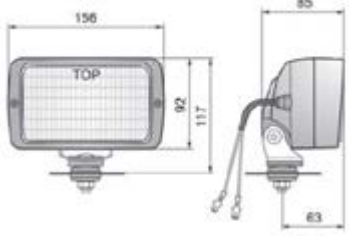

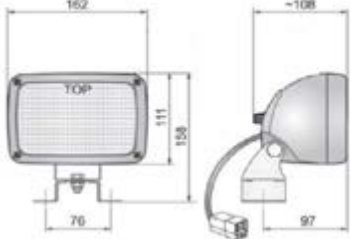

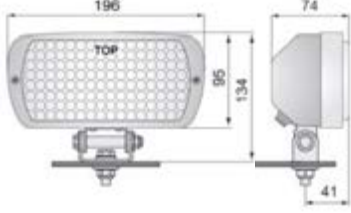

PRACOVNÍ SVĚTLOMETRY / WORK LAMPS / ARBEITSSCHEINWERFER / РАБОЧИЕ ЛАМПЫ

KÓD / ORDER CODE / BESTELL NR. / КОД		POPIS / DESCRIPTION / BESCHREIBUNG / ОПИСАНИЕ	OE / OE NUMBER / OE NUMBER / OE	NÁKRES / DRAWING / ZEICHNUNG / ЧЕРТЁЖ
720250		 <p>Material: Plastic</p> <ul style="list-style-type: none"> Průchodka, vypínač, uchycení ve tvaru U Grommet and switch, U-Shaped base Verschraubung und Schalter, Befestigungsbügel-U Прокладка, выключатель, крепление в виде U 		
720226		  <p>Material: Plastic</p> <ul style="list-style-type: none"> 2 pólový konektor, uchycení: matice + šroub M8 2x poles connector, mounting: screw + nut M8 2x pole contact, montage: schraube + mutter M8 2 полюсовый конектор, крепление - гайки + болты M8 		
720549		  <p>Material: Plastic</p> <ul style="list-style-type: none"> 2 pólový konektor, kabel - 0,1 m, uchycení: matice + šroub M8 2x poles connector, cabel - 0,1 m, mounting: screw + nut M8 2x pole contact, kabel - 0,1 m, montage: schraube + mutter M8 2 полюсовый конектор, длина провода - 0,1 метра крепление - гайки+болты M8 		
			722909 722910	12V 24V H3 12V 55W, PK22s H3 24V 70W, PK22s

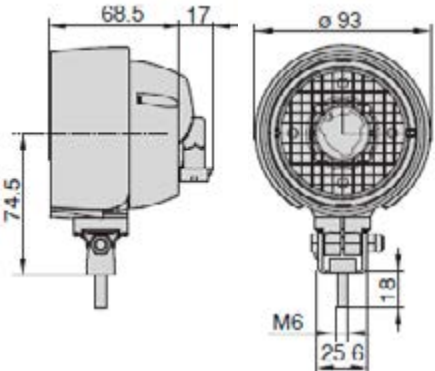

PRACOVNÍ SVĚTLOMETRY / WORK LAMPS /
ARBEITSSCHEINWERFER / РАБОЧИЕ ЛАМПЫ

KÓD / ORDER CODE / BESTELL NR. / КОД		POPIS / DESCRIPTION/ BESCHREIBUNG / ОПИСАНИЕ	OE / OE NUMBER / OE NUMMER / OE	NÁKRES / DRAWING / ZEICHNUNG / ЧЕРТЁЖ
725655		<p>IP 55 </p> <p>Material: Plastic</p> <ul style="list-style-type: none"> ■ Uchycení: matice + šroub M8, kabel - 0,15 m ■ Mounting: screw + nut M8, cabel - 0,15 m ■ Montage: schraube + mutter M8, kabel - 0,15 m ■ длина провода - 0,15 метра, крепление - гайки + болты M8 		
725690		<p>IP 65 </p> <p>Material: Plastic</p> <ul style="list-style-type: none"> ■ Uchycení: matice + šroub M8, kabel - 0,15 m ■ Mounting: screw + nut M8, cabel - 0,15 m ■ Montage: schraube + mutter M8, kabel - 0,15 m ■ длина провода - 0,15 метра, крепление - гайки + болты M8 		
728372		<p>IP 65 </p> <p>Material: Plastic</p> <ul style="list-style-type: none"> ■ Průchodka, mřížka, uchycení: matice + šroub M8 ■ Grommet, grid, mounting: screw + nut M8 ■ Verschraubung, gitter, montage: schraube + mutter M8 ■ Прокладка, сетка, крепление - гайки + болты M8 		
			<p>722909</p> <p>722910</p>	<p>12V H3 12V 55W, PK22s</p> <p>24V H3 24V 70W, PK22s</p>

PRACOVNÍ SVĚTLOMETY / WORK LAMPS / ARBEITSSCHEINWERFER / РАБОЧИЕ ЛАМПЫ

KÓD / ORDER CODE / BESTELL NR. / КОД		POPIS / DESCRIPTION/ BESCHREIBUNG / ОПИСАНИЕ	OE / OE NUMBER / OE NUMBER / OE	
727149	 	 <p>Material: Plastic</p> <ul style="list-style-type: none"> ■ Uchycení matice + šroub M6 ■ Mounting: screw + nut M6 ■ Montage: schraube + mutter M6 ■ Крепление: гайки + болты + длина M6 	05.1610.0000 19.351.903	
		722996	12V	H9 12V, PGJ-19-5
		Kabel / Cable / Кабель / Kabel		
		720107		
KÓD / ORDER CODE / BESTELL NR. / КОД		POPIS / DESCRIPTION/ BESCHREIBUNG / ОПИСАНИЕ	OE / OE NUMBER / OE NUMBER / OE	
727151	 	 <p>Material: Plastic</p> <ul style="list-style-type: none"> ■ Součást hlavního světlometu ZETOR ■ Part of the headlight ZETOR ■ Ein Teil des Scheinwerfers ZETOR ■ Часть фары ZETOR 	05.1193.0000 55.350.904	
		722996	12V	H9 12V, PGJ-19-5
		Opravná sada / Repair kit / Abschlussatz / Ремонтный комплект		
		720360		

**PRACOVNÍ SVĚTLOMETY / WORK LAMPS /
ARBEITSSCHEINWERFER / РАБОЧИЕ ЛАМПЫ**

KÓD / ORDER CODE / BESTELL NR. / КОД		POPIS / DESCRIPTION/ BESCHREIBUNG / ОПИСАНИЕ	OE / OE NUMBER / OE NUMBER / OE
727137 PRAVÁ / RIGHT / RECHTS / ПРАВАЯ	 	 <ul style="list-style-type: none"> Uchycení: matice + šroub M8, kabel - 0,2 m Mounting: screw + nut M8m, cabel - 0,2 m Montage: schraube + mutter M8, kabel - 0,2 m длина провода - 0,2 метра, крепление - гайки + болты M8 	05.1099.0000
727136 LEVÁ / LEFT / LINKS / ЛЕВАЯ			05.1098.0000

722909	12V	H3 12V 55W, PK22s
722910	24V	H3 24V 70W, PK22s

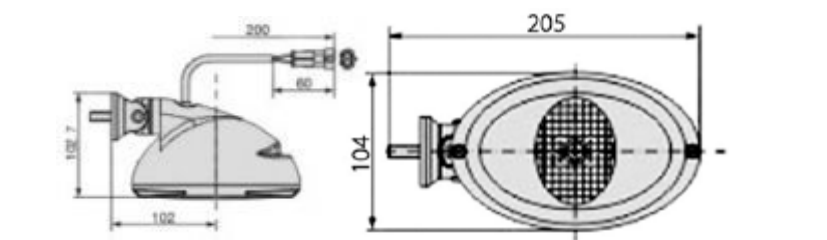

Opravná sada / Repair kit / Abschlussatz / Ремонтный комплект		
720019		

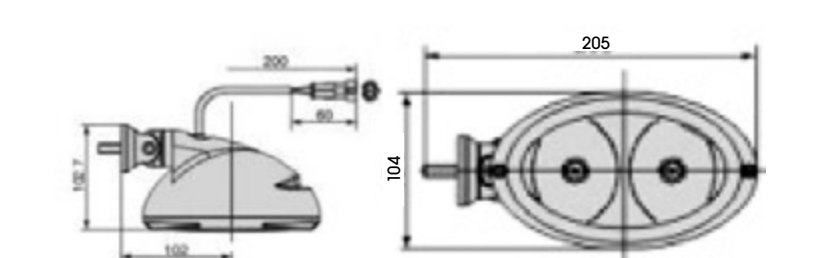

KÓD / ORDER CODE / BESTELL NR. / КОД		POPIS / DESCRIPTION/ BESCHREIBUNG / ОПИСАНИЕ	OE / OE NUMBER / OE NUMBER / OE
727140 PRAVÁ / RIGHT / RECHTS / ПРАВАЯ	 	 <ul style="list-style-type: none"> Uchycení: matice + šroub M8, kabel - 0,2 m Mounting: screw + nut M8m, cabel - 0,2 m Montage: schraube + mutter M8, kabel - 0,2 m длина провода - 0,2 метра, крепление - гайки + болты M8 	05.1155.0000
727139 LEVÁ / LEFT / LINKS / ЛЕВАЯ			05.1154.0000

722909	12V	H3 12V 55W, PK22s
722910	24V	H3 24V 70W, PK22s



Opravná sada / Repair kit / Abschlussatz / Ремонтный комплект		
720019		

PRACOVNÍ SVĚTLOMETY / WORK LAMPS / ARBEITSSCHEINWERFER / РАБОЧИЕ ЛАМПЫ

KÓD / ORDER CODE / BESTELL NR. / КОД	POPIS / DESCRIPTION / BESCHREIBUNG / ОПИСАНИЕ	OE / OE NUMBER / OE NUMBER / OE
721613	  <p> <ul style="list-style-type: none"> Uchycení: matice + šroub M8, kabel - 0,2 m Mounting: screw + nut M8m, cabel - 0,2 m Montage: schraube + mutter M8, kabel - 0,2 m длина провода - 0,2 метра, крепление - гайки + болты M8 </p>	05.1350.0000

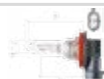

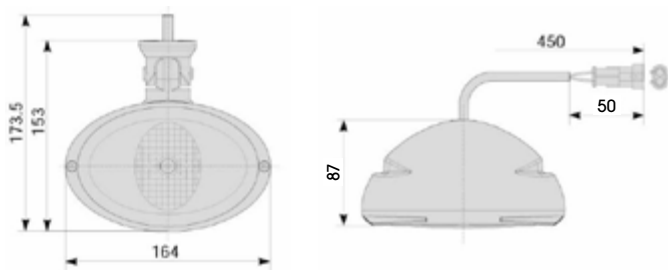

722909	12V	H3 12V 55W, PK22s
722910	24V	H3 24V 70W, PK22s



Opravná sada / Repair kit / Abschlussatz / Ремонтный комплект

720019	
--------	---

KÓD / ORDER CODE / BESTELL NR. / КОД	POPIS / DESCRIPTION / BESCHREIBUNG / ОПИСАНИЕ	OE / OE NUMBER / OE NUMBER / OE
727141	  <p> <ul style="list-style-type: none"> Uchycení: matice + šroub M8, kabel - 0,2 m Mounting: screw + nut M8m, cabel - 0,2 m Montage: Schraube + Mutter M8, kabel - 0,2 m длина провода - 0,2 метра, крепление - гайки + болты M8 </p>	05.1156.0000



722909	12V	H3 12V 55W, PK22s
722910	24V	H3 24V 70W, PK22s

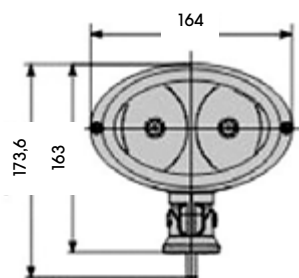







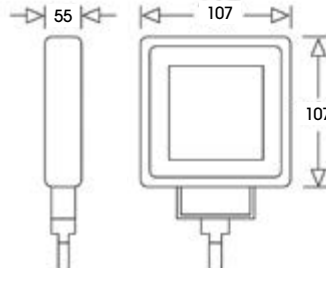

Opravná sada / Repair kit / Abschlussatz / Ремонтный комплект

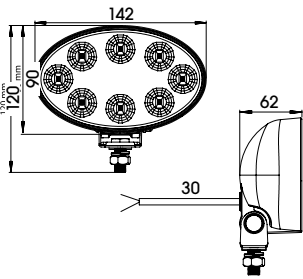
720019	
--------	---

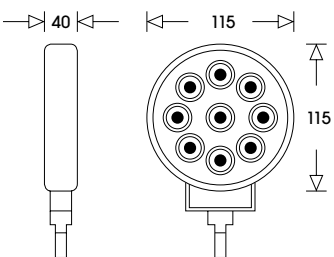
PRACOVNÍ SVĚTLOMETY / WORK LAMPS / ARBEITSSCHEINWERFER / РАБОЧИЕ ЛАМПЫ

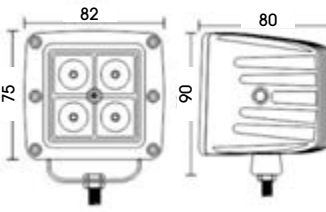
KÓD / ORDER CODE / BESTELL NR. / КОД		POPIS / DESCRIPTION/ BESCHREIBUNG / ОПИСАНИЕ	OE / OE NUMBER / OE NUMBER / OE	NÁKRES / DRAWING / ZEICHNUNG / ЧЕРТЁЖ
720171	 <p>985 LUMEN</p>	<p>9-33V IP 67 LED WATER PROOF</p> <p>5xLED, 15W, Material: aluminium, 12V - 1,8 A, 24V - 0,9 A</p> <ul style="list-style-type: none"> Uchycení: matice + šroub M7, kabel - 0,35 m Mounting: screw + nut M7, cabel - 0,35 m Montage: schraube + mutter M7, kabel - 0,35 m Крепление: гайки + болты M7, длина провода - 0,35 метра 		
720169	 <p>1710 LUMEN</p>	<p>9-33V IP 68 LED WATER PROOF</p> <p>9xLED, 27W, Material: aluminium, 12V - 1,7 A, 24V - 0,9 A</p> <ul style="list-style-type: none"> Uchycení: matice + šroub M7, kabel - 0,35 m Mounting: screw + nut M7, cabel - 0,35 m Montage: Schraube + mutter M7, kabel - 0,35 m, Крепление: гайки + болты M7, длина провода - 0,35 метра 		
720046	 <p>1710 LUMEN</p>	<p>9-33V IP 68 LED WATER PROOF</p> <p>9xLED, 27W, Material: aluminium, 12V - 1,7 A, 24V - 0,9 A</p> <ul style="list-style-type: none"> Uchycení: matice + šroub M7, kabel - 5 m Mounting: screw + nut M7, cable - 5 m Montage: schraube + mutter M7, kabel - 5 m Крепление: гайки + болты M7, длина провода 5 метра 		
720047	 <p>1710 LUMEN</p>	<p>9-33V IP 68 LED WATER PROOF</p> <p>9xLED, 27W, Material: aluminium, 12V - 1,7 A, 24V - 0,9 A</p> <ul style="list-style-type: none"> Uchycení: matice+šroub M7, kabel - 8 m Mounting: screw + nut M7, cable - 8 m Montage: schraube + mutter M7, kabel - 8 m Крепление: гайки + болты M7, длина провода 8 метра 		
720168	 <p>3040 LUMEN</p>	<p>9-33V IP 68 LED WATER PROOF</p> <p>16xLED, 48W, Material: aluminium, 12V - 3,8 A, 24V - 1,9 A</p> <ul style="list-style-type: none"> Uchycení: matice + šroub M7, kabel - 0,35 m Mounting: screw + nut M7, cable - 0,35 m Montage: schraube + mutter M7, kabel - 0,35 m Крепление: гайки + болты M7, длина провода - 0,35 метра 		

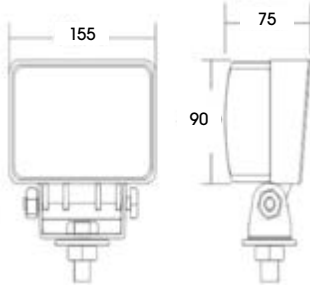
PRACOVNÍ SVĚTLOMETY / WORK LAMPS / ARBEITSSCHEINWERFER / РАБОЧИЕ ЛАМПЫ

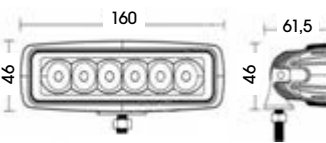
KÓD / ORDER CODE / BESTELL NR. / КОД		POPIS / DESCRIPTION / BESCHREIBUNG / ОПИСАНИЕ	OE / OE NUMBER / OE NUMBER / OE	NÁKRES / DRAWING / ZEICHNUNG / ЧЕРТЁЖ
720073	 <p>LUMINEX 1560 LUMEN</p>	<p>9-33V IP 67 LED WATER PROOF</p> <p>8xLED, 24W, Material: aluminium, 12V - 2 A, 24V - 1 A</p> <ul style="list-style-type: none"> Uchycení: matice + šroub M7, kabel - 0,35 m Mounting: screw + nut M7, cable - 0,35 m Montage: schraube + mutter M7, kabel - 0,35 m Крепление: гайки + болты M7, длина провода - 0,35метра 		 <p>142 90 120 mm 62 30</p>
720076	 <p>LUMINEX 1755 LUMEN</p>	<p>9-33V IP 67 LED WATER PROOF</p> <p>9xLED, 24W, Material: aluminium, 12V - 2 A, 24V - 1 A</p> <ul style="list-style-type: none"> Uchycení: matice + šroub M7, kabel - 0,35 m Mounting: screw + nut M7, cable - 0,35 m Montage: schraube + mutter M7, kabel - 0,35 m Крепление: гайки + болты M7, длина провода - 0,35 метра 		 <p>40 115 115</p>
725656	 <p>LUMINEX 1800 LUMEN</p>	<p>9-33V LED WATER PROOF</p> <p>4xLED, Material: aluminium</p> <ul style="list-style-type: none"> Uchycení: matice + šroub M8, kabel - 1,5 m Mounting: screw + nut M8, kabel - 1,5 m Montage: schraube + mutter M8, kabel - 1,5 m Крепление: гайки + болты + длина M8, провода - 1,5 метра 		 <p>82 75 80 90</p>
720170	 <p>LUMINEX 2850 LUMEN</p>	<p>9-33V LED WATER PROOF</p> <p>15xLED, 45W, Material: aluminium</p> <ul style="list-style-type: none"> Uchycení matice + šroub M8, Kabel - 0,4 m Mounting: screw + nut M8, Kabel - 0,4 m Montage: Schraube + Mutter M8, Kabel - 0,4 m Крепление - гайки+болты + длина M8, провода - 0,4 метра 		 <p>155 75 90</p>
725691	 <p>LUMINEX 1260 LUMEN</p>	<p>9-33V LED WATER PROOF</p> <p>6xLED, 45W, Material: aluminium</p> <ul style="list-style-type: none"> Uchycení matice + šroub M8, Kabel - 0,35 m Mounting: screw + nut M8, Kabel - 0,35 m Montage: Schraube + Mutter M8, Kabel - 0,35 m Крепление - гайки+болты + длина M8, провода - 0,35 метра 		 <p>160 46 61,5 46</p>

LUMINEX[®]



5040 LUMEN

9-33V IP 67 LED E WATER PROOF

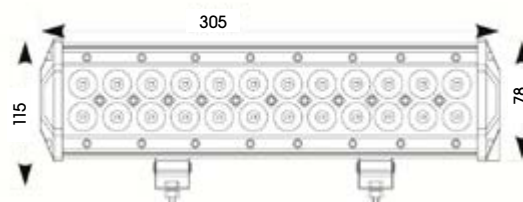

KÓD / ORDER CODE / BESTELL NR. / КОД	POPIS / DESCRIPTION/ BESCHREIBUNG / ОПИСАНИЕ	
725692	<p>24xLED, 72W, Material - aluminium</p> <ul style="list-style-type: none"> Uchycení: matice + šroub M8, Kabel - 0,3 m Mounting: screw + nut M8, Cabel - 0,3 m Montage: Schraube + Mutter M8, Kabel - 0,3 m Крепление - гайки + болты M8, длина провода - 0,3 метра 	

LUMINEX[®]



8820 LUMEN

9-33V IP 67 LED E WATER PROOF

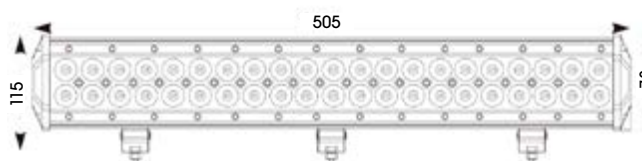

KÓD / ORDER CODE / BESTELL NR. / КОД	POPIS / DESCRIPTION/ BESCHREIBUNG / ОПИСАНИЕ	
725693	<p>42xLED, 126W, Material: aluminium</p> <ul style="list-style-type: none"> Uchycení: matice + šroub M8, Kabel - 0,5 m Mounting: screw + nut M8, Cabel - 0,5 m Montage: Schraube + Mutter M8, Kabel - 0,5 m Крепление - гайки + болты M8, длина провода - 0,5 метра 	

LUMINEX[®]



12600 LUMEN

9-33V IP 67 LED E WATER PROOF

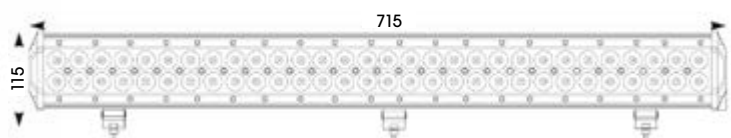

KÓD / ORDER CODE / BESTELL NR. / КОД	POPIS / DESCRIPTION/ BESCHREIBUNG / ОПИСАНИЕ	
725694	<p>60xLED, 180W, Material: aluminium</p> <ul style="list-style-type: none"> Uchycení: matice + šroub M8, Kabel - 0,6 m Mounting: screw + nut M8, Cabel - 0,6 m Montage: Schraube + Mutter M8, Kabel - 0,6 m Крепление - гайки + болты M8, длина провода - 0,6 метра 	

LED 12-24V PRACOVNÍ SVĚTLOMETY / LED 12-24V WORK LAMPS / LED 12-24V ARBEITSSCHEINWERFER / СВЕТОДИОДНЫЕ 12-24 В РАБОЧИЕ ЛАМПЫ

KÓD / ORDER CODE / BESTELL NR. / КОД		POPIS / DESCRIPTION/ BESCHREIBUNG / ОПИСАНИЕ	OE / OE NUMBER / OE NUMBER / OE	NÁKRES / DRAWING / ZEICHNUNG / ЧЕРТЁЖ
725653	 1500 LUMEN	<p>9-33V IP 68 IP 69K LED WATER PROOF</p> <p>4xLED, 18W, Material: aluminium, Zetor - Major</p> <ul style="list-style-type: none"> Uchycení: matice + šroub, kabel - 1,5 m Mounting: screw + nut, cabel - 1,5 m Montage: schraube + mutter, kabel - 1,5 m Крепление: гайки + болты, длина провода - 1,5 метра 	93-5577	
725652	 1000 LUMEN	<p>9-33V IP 68 IP 69K LED WATER PROOF</p> <p>4xLED, 18W, Material: aluminium, Zetor - Major</p> <ul style="list-style-type: none"> Uchycení: matice + šroub, 2x pólový konektor Mounting: screw + nut, 2x poles connector Montage: schraube + mutter, 2x pole stecker Крепление: гайки + болты, 2 полюсовый конектор 		
720244	 17500 LUMEN	<p>9-33V IP 67 LED WATER PROOF</p> <p>8xLED, 24W, Material: aluminium</p> <ul style="list-style-type: none"> Uchycení: matice + šroub M7, kabel - 0,5 m Mounting: screw + nut M7, cable - 0,5 m Montage: schraube + mutter M7, kabel - 0,5 m Крепление: гайки + болты M7, длина провода - 0,5 метра 		
720126	 2500 LUMEN	<p>9-33V IP 68 IP 69K LED WATER PROOF</p> <p>6xLED, 29W, Material: aluminium</p> <ul style="list-style-type: none"> Uchycení: matice + šroub, kabel - 0,5 m Mounting: screw + nut, cabel - 0,5 m Montage: schraube + mutter, kabel - 0,5 m Крепление: гайки + болты, длина провода - 0,5 метра 		

LED 12-24V PRACOVNÍ SVĚTLOMETY / LED 12-24V WORK LAMPS / LED 12-24V ARBEITSSCHEINWERFER / СВЕТОДИОДНЫЕ 12-24 В РАБОЧИЕ ЛАМПЫ

KÓD / ORDER CODE / BESTELL NR. / КОД	POPIS / DESCRIPTION/ BESCHREIBUNG / ОПИСАНИЕ	OE / OE NUMBER / OE NUMBER / OE	NÁKRES / DRAWING / ZEICHNUNG / ЧЕРТЁЖ
728218	<p>1300 LUMEN</p> <p>9-33V IP68 LED WATER PROOF</p> <p>9xLED, 13,5W, Material: polycarbonate, 12V - 1.1A, 24V - 0.55A</p> <ul style="list-style-type: none"> Uchyceni: matice + šroub, kabel - 1,5 m Mounting: screw + nut, cabel - 1.5 m Montage: schraube + mutter, kabel - 1,5 m Крепление: гайки + болты , длина провода - 1,5 метра 		
725681	<p>1300 LUMEN</p> <p>9-33V IP68 LED WATER PROOF</p> <p>9xLED, 13,5W, Material: polycarbonate, 12V - 1.1A, 24V - 0.55A</p> <ul style="list-style-type: none"> Uchyceni: matice + šroub, kabel - 1,5 m Mounting: screw + nut, cabel - 1.5 m Montage: schraube + mutter, kabel - 1,5 m Крепление: гайки + болты , длина провода - 1,5 метра 		
725680	<p>2800 LUMEN</p> <p>9-33V IP68 LED WATER PROOF</p> <p>9xLED, 34W, Material: aluminium, 12V - 2.8A, 24V - 1.4A</p> <ul style="list-style-type: none"> Uchyceni: matice + šroub, kabel - 1,5 m Mounting: screw + nut, cabel - 1.5 m Montage: schraube + mutter, kabel - 1,5 m Крепление: гайки + болты , длина провода - 1,5 метра 		

Rám na pracovní světlo / Frame for working floodlight / Rahmen für Arbeitsscheinwerfer / Рамка для рабочего прожектора



□ 725682

■ 725683

■ 725684

■ 725685

■ 725686

■ 725687

LED COUVACÍ SVÍTILNY / LED REVERSING LAMP / СВЕТОДИОДНЫЕ ФАРЫ ЗАДНЕГО ХОДА / LED RÜCKFAHRLEUCHE

KÓD / ORDER CODE / BESTELL NR. / КОД	POPIS / DESCRIPTION/ BESCHREIBUNG / ОПИСАНИЕ	OE / OE NUMBER / OE NUMBER / OE	NÁKRES / DRAWING / ZEICHNUNG / ЧЕРТЕЖ
720083	<p>650 LUMEN</p> <p>9-33V EMC LED E WATER PROOF</p> <p>5xLED</p> <ul style="list-style-type: none"> Uchycení: matice + šroub, kabel - 2,5 m Mounting: screw + nut, cabel - 2,5 m Montage: schraube + mutter, kabel - 2,5 m Крепление: гайки + болты, длина провода - 2,5 метра 	39-6400-017	
720080	<p>1560 LUMEN</p> <p>9-33V ECE EMC LED E WATER PROOF</p> <p>10xLED</p> <ul style="list-style-type: none"> Uchycení: matice + šroub, kabel - 2,5 m Mounting: screw + nut, cabel - 2,5 m Montage: schraube + mutter, kabel - 2,5 m Крепление: гайки + болты, длина провода - 2,5 метра 	38-8200-007	
728270	<p>1800 LUMEN</p> <p>9-33V IP 66 IP 68 LED E</p> <p>9xLED, Material: plastic</p> <ul style="list-style-type: none"> Uchycení: matice + šroub, kabel - 2,5 m Mounting: screw + nut, cabel - 2,5 m Montage: schraube + mutter, kabel - 2,5 m Крепление: гайки + болты, длина провода - 2,5 метра 		
728269	<p>2400 LUMEN</p> <p>9-33V IP 66 IP 68 LED E</p> <p>12xLED, Material: plastic</p> <ul style="list-style-type: none"> Uchycení: matice + šroub, kabel - 2,5 m Mounting: screw + nut, cabel - 2,5 m Montage: schraube + mutter, kabel - 2,5 m Крепление: гайки + болты, длина провода - 2,5 метра 		
728268	<p>200 LUMEN</p> <p>9-33V EMC LED E</p> <p>9xLED, Material: polycarbonate, 12V - 0.28A, 24V - 0.14A</p> <ul style="list-style-type: none"> Uchycení: matice + šroub, kabel - 1,5 m Mounting: screw + nut, cabel - 1,5 m Montage: schraube + mutter, kabel - 1,5 m Крепление: гайки + болты, длина провода - 1,5 метра 		

DRŽÁK / HOLDER / HALTER / ДЕРЖАТЕЛЬ

KÓD / ORDER CODE / BESTELL NR. / КОД		POPIS / DESCRIPTION/ BESCHREIBUNG / ОПИСАНИЕ	OE / OE NUMBER / OE NUMMER / OE	NÁKRES / DRAWING / ZEICHNUNG / ЧЕРТЁЖ
723777		<ul style="list-style-type: none"> ■ Držák - U ■ Holder - U ■ Halter - U ■ Держатель - U 		
723776		<ul style="list-style-type: none"> ■ Magnetický držák ■ Magnetic holder ■ Magnet Halter ■ Магнитный держатель 		



**HLAVNÍ SVĚTLOMETY /
HEAD LAMPS /
HAUPTSCHNWERFER /
ПЕРЕДНИЕ ФАРЫ**



HLAVNÍ SVĚTLOMETY / HEAD LAMPS / HAUPTSCHWEINWERFER / ПЕРЕДНИЕ ФАРЫ

KÓD / ORDER CODE / BESTELL NR. / КОД		POPIS / DESCRIPTION/ BESCHREIBUNG / ОПИСАНИЕ	OE / OE NUMBER / OE NUMBER / OE
728366 PRAVÁ / RIGHT / RECHTS / ПРАВАЯ		<p>IP 55 E</p> <p>Material: plastik</p> <ul style="list-style-type: none"> Uchycení: matice + šroub M10, kabel 1,7 m Mounting: screw + nut M10, cable 1,7 m Montage: schraube + mutter M10, kabel 1,7 m Крепление: гайки + болты M10, Кабель 1,7 м 	
728367 LEVÁ / LEFT / LINKS / ЛЕВАЯ			

728368 PRAVÁ / RIGHT / RECHTS / ПРАВАЯ		<p>IP 55 E</p> <p>Material: plastik</p> <ul style="list-style-type: none"> Uchycení: matice + šroub M10, zástrčka Deutsch Mounting: screw + nut M10, socket Deutsch Montage: schraube + mutter M10, buchse Deutsch Крепление: гайки + болты M10, гнездо Deutsch 	
728369 LEVÁ / LEFT / LINKS / ЛЕВАЯ			

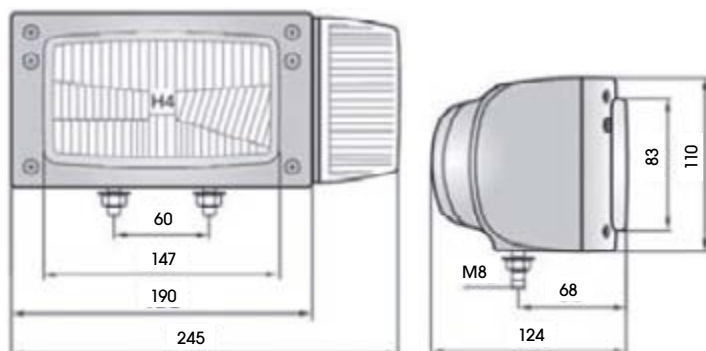

722915	12V	H4 12V, 55/60W
722931	12V	P21W 12V, BA15s
722948	12V	T4W 12V, BA9s
722916	24V	H4 24V, 70/75W
722932	24V	P21W 24V, BA15s
722949	24V	T4W 24V, BA9s

Opravná sada / Repair kit / Abschlussatz / Ремонтный комплект

721069	
--------	---

KÓD / ORDER CODE / BESTELL NR. / КОД		POPIS / DESCRIPTION/ BESCHREIBUNG / ОПИСАНИЕ	OE / OE NUMBER / OE NUMBER / OE
727316		<p>E</p> <ul style="list-style-type: none"> Směrová svítidla Indicator lamp Blinkleuchte индикатор направления 	

HLAVNÍ SVĚTLOMETY / HEAD LAMPS / HAUPTSCHNOWERFER / ПЕРЕДНИЕ ФАРЫ

KÓD / ORDER CODE / BESTELL NR. / КОД		POPIS / DESCRIPTION/ BESCHREIBUNG / ОПИСАНИЕ	OE / OE NUMBER / OE NUMBER / OE
728380 PRAVÁ / RIGHT / RECHTS / ПРАВАЯ		<p>IP 55 E</p> <p>Material: plastik</p> <ul style="list-style-type: none"> ■ Uchycení: matice + šroub, zástrčka Deutsch ■ Mounting: screw + nut, socket Deutsch ■ Montage: schraube + mutter, buchse Deutsch ■ Крепление: гайки + болты, гнездо Deutsch 	
728381 LEVÁ / LEFT / LINKS / ЛЕВАЯ			

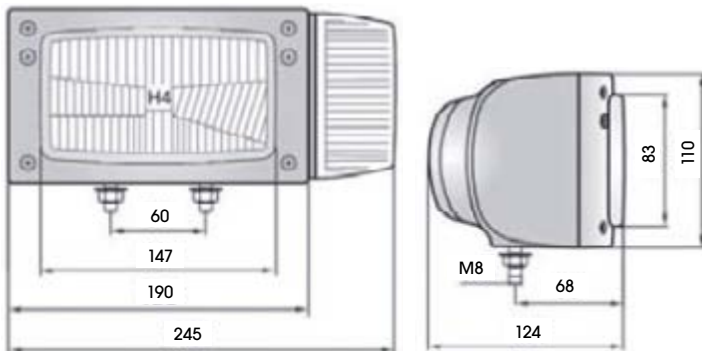

722915	12V	H4 12V, 55/60W
722931	12V	P21W 12V, BA15s
722956	12V	W5W 12V, W2.1x9.5d
722916	24V	H4 24V, 70/75W
722932	24V	P21W 24V, BA15s
722957	24V	W5W 24V, W2.1x9.5d

Opravná sada / Repair kit / Abschlussatz / Ремонтный комплект

721069	
---------------	---



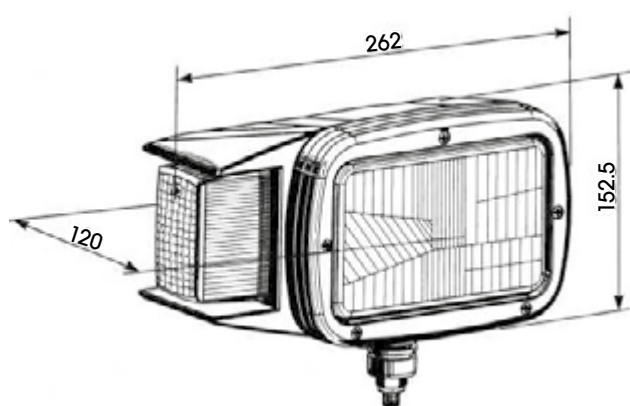

KÓD / ORDER CODE / BESTELL NR. / КОД		POPIS / DESCRIPTION/ BESCHREIBUNG / ОПИСАНИЕ	OE / OE NUMBER / OE NUMBER / OE
727316		<p>E</p> <ul style="list-style-type: none"> ■ Směrová svítidla ■ Indicator lamp ■ Blinkleuchte ■ индикатор направления 	

HLAVNÍ SVĚTLOMETY / HEAD LAMPS / HAUPTSCHENWERFER / ПЕРЕДНИЕ ФАРЫ



KÓD / ORDER CODE / BESTELL NR. / КОД		POPIS / DESCRIPTION/ BESCHREIBUNG / ОПИСАНИЕ	OE / OE NUMBER / OE NUMBER / OE
727115 PRAVÁ / RIGHT / RECHTS / ПРАВАЯ	 	IP 54 Material: plastik <ul style="list-style-type: none"> ■ Uchyceni: matice + šroub ■ Mounting: screw + nut, ■ Montage: schraube + mutter ■ Крепление: гайки + болты 	05.479.000.01
727116 LEVÁ / LEFT / LINKS / ЛЕВАЯ			05.483.000.01



722915	12V	H4 12V, 55/60W
722931	12V	P21W 12V, BA15s
722948	12V	T4W 12V, BA9s
722916	24V	H4 24V, 70/75W
722932	24V	P21W 24V, BA15s
722949	24V	T4W 24V, BA9s

KÓD / ORDER CODE / BESTELL NR. / КОД		POPIS / DESCRIPTION/ BESCHREIBUNG / ОПИСАНИЕ	OE / OE NUMBER / OE NUMBER / OE
727319		 <ul style="list-style-type: none"> ■ Směrová svítidla ■ Indicator lamp ■ Blinkleuchte ■ индикатор направления 	
727156		 <ul style="list-style-type: none"> ■ Rámeček ■ Frame ■ Rahmen ■ Рамка 	05.478.002

HLAVNÍ SVĚTLOMETY / HEAD LAMPS / HAUPTSCHWEINWERFER / ПЕРЕДНИЕ ФАРЫ

KÓD / ORDER CODE / BESTELL NR. / КОД	POPIS / DESCRIPTION/ BESCHREIBUNG / ОПИСАНИЕ	OE / OE NUMBER / OE NUMBER / OE
727127 PRAVÁ / RIGHT / RECHTS / ПРАВАЯ	 	05.0918.0000.01 1013426
727128 LEVÁ / LEFT / LINKS / ЛЕВАЯ		

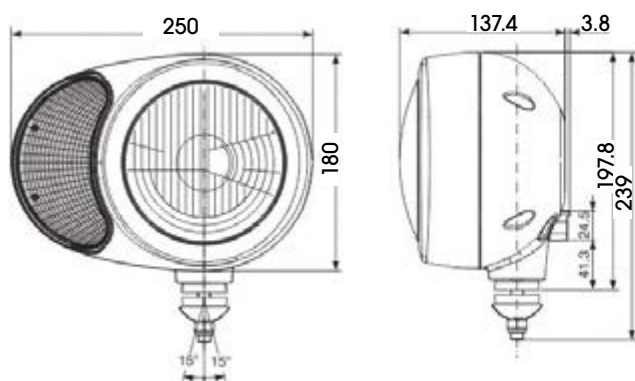

722915	12V	H4 12V, 55/60W
722931	12V	P21W 12V, BA15s
722948	12V	T4W 12V, BA9s
722916	24V	H4 24V, 70/75W
722932	24V	P21W 24V, BA15s
722949	24V	T4W 24V, BA9s

Opravná sada / Repair kit / Abschlussatz / Ремонтный комплект

721069



KÓD / ORDER CODE / BESTELL NR. / КОД	POPIS / DESCRIPTION/ BESCHREIBUNG / ОПИСАНИЕ	OE / OE NUMBER / OE NUMBER / OE
727131 PRAVÁ / RIGHT / RECHTS / ПРАВАЯ	 	05.0922.0000.01
727132 LEVÁ / LEFT / LINKS / ЛЕВАЯ		

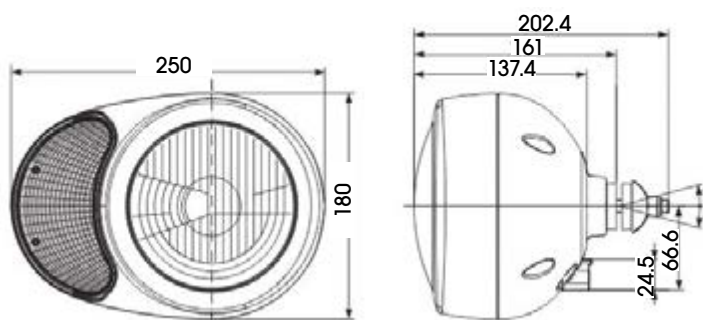

722915	12V	H4 12V, 55/60W
722931	12V	P21W 12V, BA15s
722948	12V	T4W 12V, BA9s
722916	24V	H4 24V, 70/75W
722932	24V	P21W 24V, BA15s
722949	24V	T4W 24V, BA9s



Opravná sada / Repair kit / Abschlussatz / Ремонтный комплект

721069



Important notice: part of other producers are only mentioned for comparison purposes.

HLAVNÍ SVĚTLOMETY / HEAD LAMPS / HAUPTSCHWEINWERFER / ПЕРЕДНИЕ ФАРЫ

KÓD / ORDER CODE / BESTELL NR. / КОД	POPIS / DESCRIPTION/ BESCHREIBUNG / ОПИСАНИЕ	OE / OE NUMBER / OE NUMBER / OE
726802 PRAVÁ / RIGHT / RECHTS / ПРАВАЯ	  <p> E Material: plastik ■ Uchycení: matice + šroub M10 ■ Mounting: screw + nut M10 ■ Montage: Schraube + Mutter M10 ■ Крепление: гайки + болты M10 </p>	1EA993975-061 607149308
726801 LEVÁ / LEFT / LINKS / ЛЕВАЯ		1EA993975-051 607149208

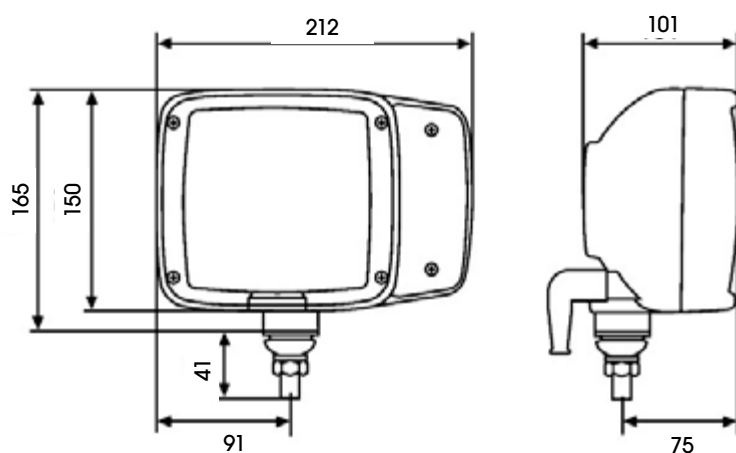

722909	12V	H3 12V 55W, PK22s
722924	12V	H7 12V 55W, Px26d
722931	12V	P21W 12V, BA15s
722948	12V	T4W 12V, BA9s
722910	24V	H3 24V 70W, PK22s
722925	24V	H7 24V 70W, Px26d
722932	24V	P21W 24V, BA15s
722949	24V	T4W 24V, BA9s

Lens / Крышка / Lichtscheibe / Kryt

726803



KÓD / ORDER CODE / BESTELL NR. / КОД	POPIS / DESCRIPTION/ BESCHREIBUNG / ОПИСАНИЕ	OE / OE NUMBER / OE NUMBER / OE
726911 PRAVÁ / RIGHT / RECHTS / ПРАВАЯ	 <p> Material: plastik ■ Uchycení: matice + šroub M10 ■ Mounting: screw + nut M10 ■ Montage: Schraube + Mutter M10 ■ Крепление: гайки + болты M10 </p>	
726912 LEVÁ / LEFT / LINKS / ЛЕВАЯ		

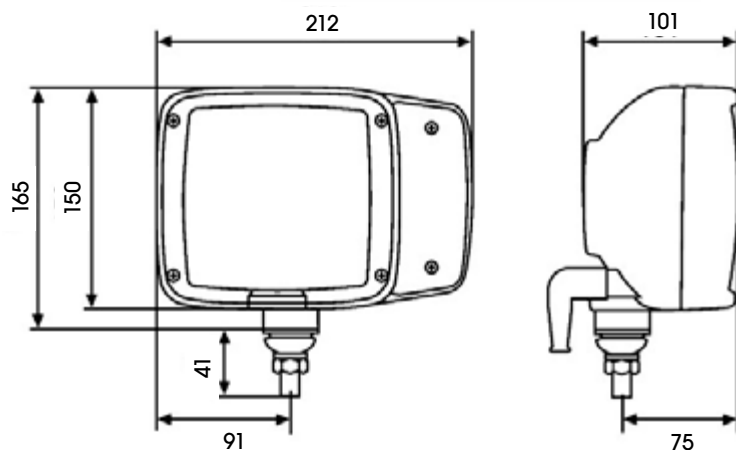

722915	12V	H4 12V, 55/60W
722948	12V	T4W 12V, BA9s
722916	24V	H4 24V, 70/75W
722949	24V	T4W 24V, BA9s

Lens / Крышка / Lichtscheibe / Kryt

726803



HLAVNÍ SVĚTLOMETY / HEAD LAMPS / HAUPTSCHWEINWERFER / ПЕРЕДНИЕ ФАРЫ

KÓD / ORDER CODE / BESTELL NR. / КОД		POPIS / DESCRIPTION/ BESCHREIBUNG / ОПИСАНИЕ	OE / OE NUMBER / OE NUMBER / OE
728379		<p>IP 66 E</p> <p>Material: plastik</p> <ul style="list-style-type: none"> Uchycení: matice + šroub, zástrčka Deutsch Mounting: screw + nut, socket Deutsch Montage: schraube + mutter, buchse Deutsch Крепление: гайки + болты, гнездо Deutsch 	

728382 PRAVÁ / RIGHT / RECHTS / ПРАВАЯ		<p>IP 66 E</p> <p>Material: plastik</p> <ul style="list-style-type: none"> Uchycení: matice + šroub, zástrčka Deutsch Mounting: screw + nut, socket Deutsch Montage: schraube + mutter, buchse Deutsch Крепление: гайки + болты, гнездо Deutsch 	
728383 LEVÁ / LEFT / LINKS / ЛЕВАЯ			

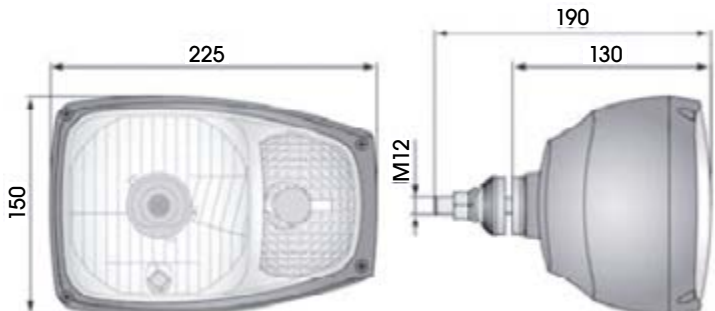
	722915	12V	H4 12V, 55/60W
	722934	12V	PY21W 12V, BAU15s
	722956	12V	W5W 12V, W2.1x9.5d
	722916	24V	H4 24V, 70/75W
	722935	24V	PY21W 24V, BAU15s
	722957	24V	W5W 24V, W2.1x9.5d

Opravná sada / Repair kit / Abschlusssatz / Ремонтный комплект		
721069		

HLAVNÍ SVĚTLOMETY / HEAD LAMPS / HAUPTSCHWEINWERFER / ПЕРЕДНИЕ ФАРЫ

KÓD / ORDER CODE / BESTELL NR. / КОД		POPIS / DESCRIPTION/ BESCHREIBUNG / ОПИСАНИЕ	OE / OE NUMBER / OE NUMMER / OE
728396 PRAVÁ / RIGHT / RECHTS / ПРАВАЯ		<p>IP 66 </p> <p>Material: plastik</p> <ul style="list-style-type: none"> ■ Uchycení: matice + šroub, zástrčka Deutsch ■ Mounting: screw + nut, socket Deutsch ■ Montage: schraube + mutter, buchse Deutsch ■ Крепление: гайки + болты, гнездо Deutsch 	
728397 LEVÁ / LEFT / LINKS / ЛЕВАЯ			

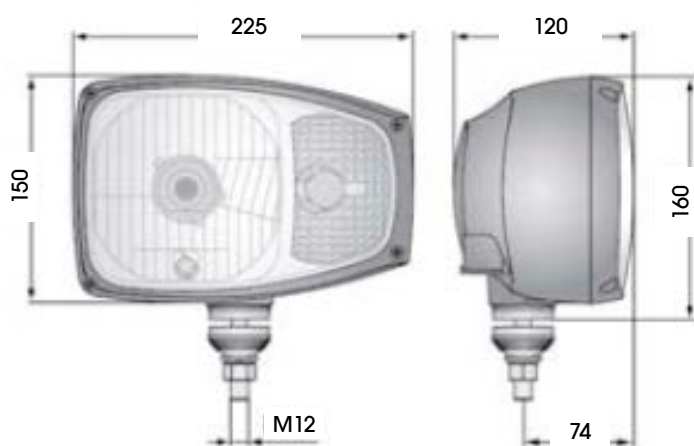

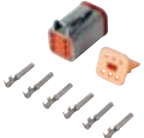

722915	12V	H4 12V, 55/60W
722934	12V	PY21W 12V, BAU15s
722956	12V	W5W 12V, W2.1x9.5d
722916	24V	H4 24V, 70/75W
722935	24V	PY21W 24V, BAU15s
722957	24V	W5W 24V, W2.1x9.5d

Opravná sada / Repair kit / Abschlussatz / Ремонтный комплект

721069	
--------	---

HLAVNÍ SVĚTLOMETY / HEAD LAMPS / HAUPTSCHWEINWERFER / ПЕРЕДНИЕ ФАРЫ

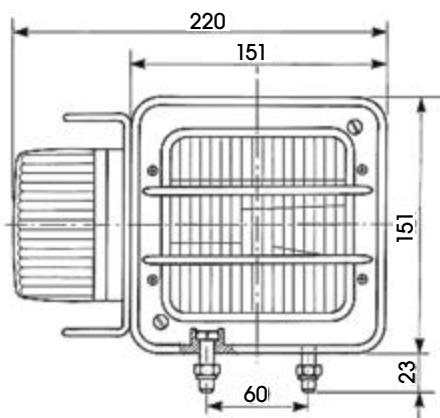

KÓD / ORDER CODE / BESTELL NR. / КОД		POPIS / DESCRIPTION/ BESCHREIBUNG / ОПИСАНИЕ	OE / OE NUMBER / OE NUMBER / OE
726734 PRAVÁ / RIGHT / RECHTS / ПРАВАЯ	 	<p>IP 66 E</p> <p>Material: černý nylon</p> <ul style="list-style-type: none"> ■ Uchycení: 2x Matice + šroub M10 ■ Mounting: 2x screw + nut M10 ■ Montage: 2x schraube + mutter M10 ■ Крепление: 2x гайки + болты M10 	05.620.000.01
724876 LEVÁ / LEFT / LINKS / ЛЕВАЯ			05.619.000.01



722992	12V	R2 12V, P45t
722948	12V	T4W 12V, BA9s
722931	12V	P21W 12V, BA15s
722993	24V	R2 24V, P45t
722949	24V	T4W 24V, BA9s
722932	24V	P21W 24V, BA15s

KÓD / ORDER CODE / BESTELL NR. / КОД		POPIS / DESCRIPTION/ BESCHREIBUNG / ОПИСАНИЕ	OE / OE NUMBER / OE NUMBER / OE
727319		<p>E</p> <ul style="list-style-type: none"> ■ Směrová svítidla ■ Indicator lamp ■ Blinkleuchte ■ индикатор направления 	

HLAVNÍ SVĚTLOMETY / HEAD LAMPS / HAUPTSCHWEINWERFER / ПЕРЕДНИЕ ФАРЫ

KÓD / ORDER CODE / BESTELL NR. / КОД		POPIS / DESCRIPTION/ BESCHREIBUNG / ОПИСАНИЕ	OE / OE NUMBER / OE NUMBER / OE
727135	 	<p>IP 66 E</p> <ul style="list-style-type: none"> ■ Rozměr: 140 x 140 mm ■ Dimensions: 140 x 140 mm ■ Das mass: 140 x 140 mm ■ Размеры: 140 x 140 mm 	05.160.000.01 1014415

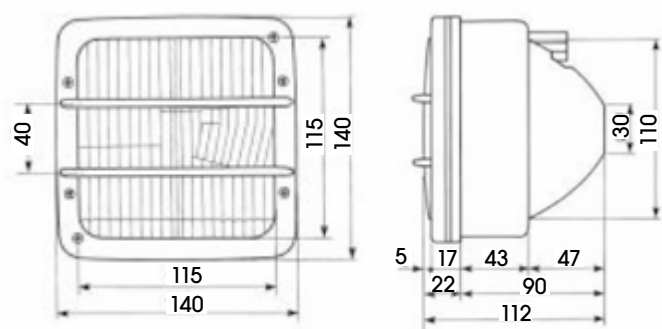

722992	12V	R2 12V, P45t
722948	12V	T4W 12V, BA9s
722931	12V	P21W 12V, BA15s
722993	24V	R2 24V, P45t
722949	24V	T4W 24V, BA9s
722932	24V	P21W 24V, BA15s

KÓD / ORDER CODE / BESTELL NR. / КОД		POPIS / DESCRIPTION/ BESCHREIBUNG / ОПИСАНИЕ	OE / OE NUMBER / OE NUMBER / OE
724889	 	<p>IP 66 E</p> <ul style="list-style-type: none"> ■ Rozměr: 140 x 140 mm ■ Dimensions: 140 x 140 mm ■ Das mass: 140 x 140 mm ■ Размеры: 140 x 140 mm 	05.160.600

HLAVNÍ SVĚTLOMETY / HEAD LAMPS / HAUPTSCHNOWERFER / ПЕРЕДНИЕ ФАРЫ

KÓD / ORDER CODE / BESTELL NR. / КОД	POPIS / DESCRIPTION/ BESCHREIBUNG / ОПИСАНИЕ	OE / OE NUMBER / OE NUMBER / OE
727110	  <p> IP 54 E Material: plastik ■ Uchytení: matice + šroub M10, Upevnění - kloubový spoj ■ Mounting: screw + nut M10, Fixing - articulated joint ■ Montage: schraube + mutter M10, Befestigung - gelenk link ■ Крепление: гайки + болты M10, фиксирование - шарнирных ссылка </p>	05.439.000.01

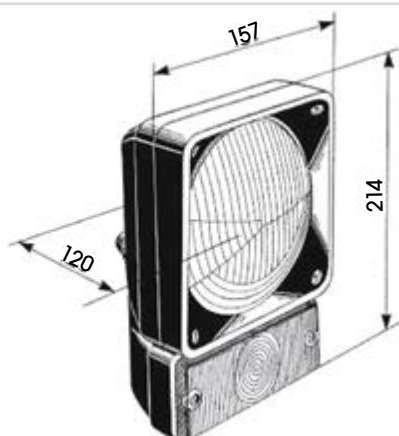

722915	12V	H4 12V, 55/60W
722931	12V	P21W 12V, BA15s
722948	12V	T4W 12V, BA9s
722916	24V	H4 24V, 70/75W
722932	24V	P21W 24V, BA15s
722949	24V	T4W 24V, BA9s

Směrovka / Front indicator / Blinkleuchte / указатель поворота

727112	
--------	---

HLAVNÍ SVĚTLOMETY / HEAD LAMPS / HAUPTSCHNOWERFER / ПЕРЕДНИЕ ФАРЫ

KÓD / ORDER CODE / BESTELL NR. / КОД		POPIS / DESCRIPTION/ BESCHREIBUNG / ОПИСАНИЕ	OE / OE NUMBER / OE NUMBER / OE
727120	 	<p>IP 54 </p> <p>Material: plastik</p> <ul style="list-style-type: none"> ■ Uchycení: matice + šroub M10 ■ Mounting: screw + nut M10 ■ Montage: schraube + mutter M10 ■ Крепление: гайки + болты M10 	1015564

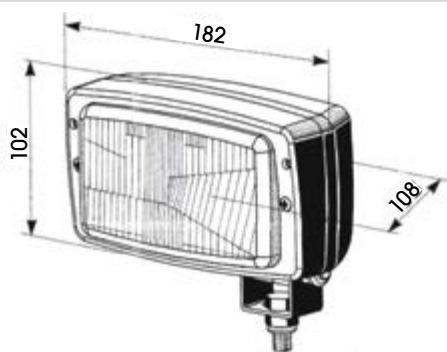

722915	12V	H4 12V, 55/60W
722948	12V	T4W 12V, BA9s
722916	24V	H4 24V, 70/75W
722949	24V	T4W 24V, BA9s

KÓD / ORDER CODE / BESTELL NR. / КОД		POPIS / DESCRIPTION/ BESCHREIBUNG / ОПИСАНИЕ	OE / OE NUMBER / OE NUMBER / OE
727114	 	<p>IP 54 </p> <p>Material: plastik</p> <ul style="list-style-type: none"> ■ Uchycení: matice + šroub M10 ■ Mounting: screw + nut M10 ■ Montage: schraube + mutter M10 ■ Крепление: гайки + болты M10 	05.487.000.01

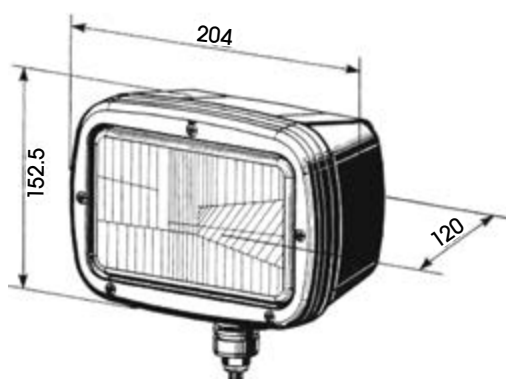

722915	12V	H4 12V, 55/60W
722948	12V	T4W 12V, BA9s
722916	24V	H4 24V, 70/75W
722949	24V	T4W 24V, BA9s

**PŘEDNÍ POZIČNÍ SVÍTILNY /
FRONT POSITION LAMP /
VORDERE POSITIONLEUCHE /
ПЕРЕДНЕГО УКАЗАТЕЛЯ ПОВОРОТА**

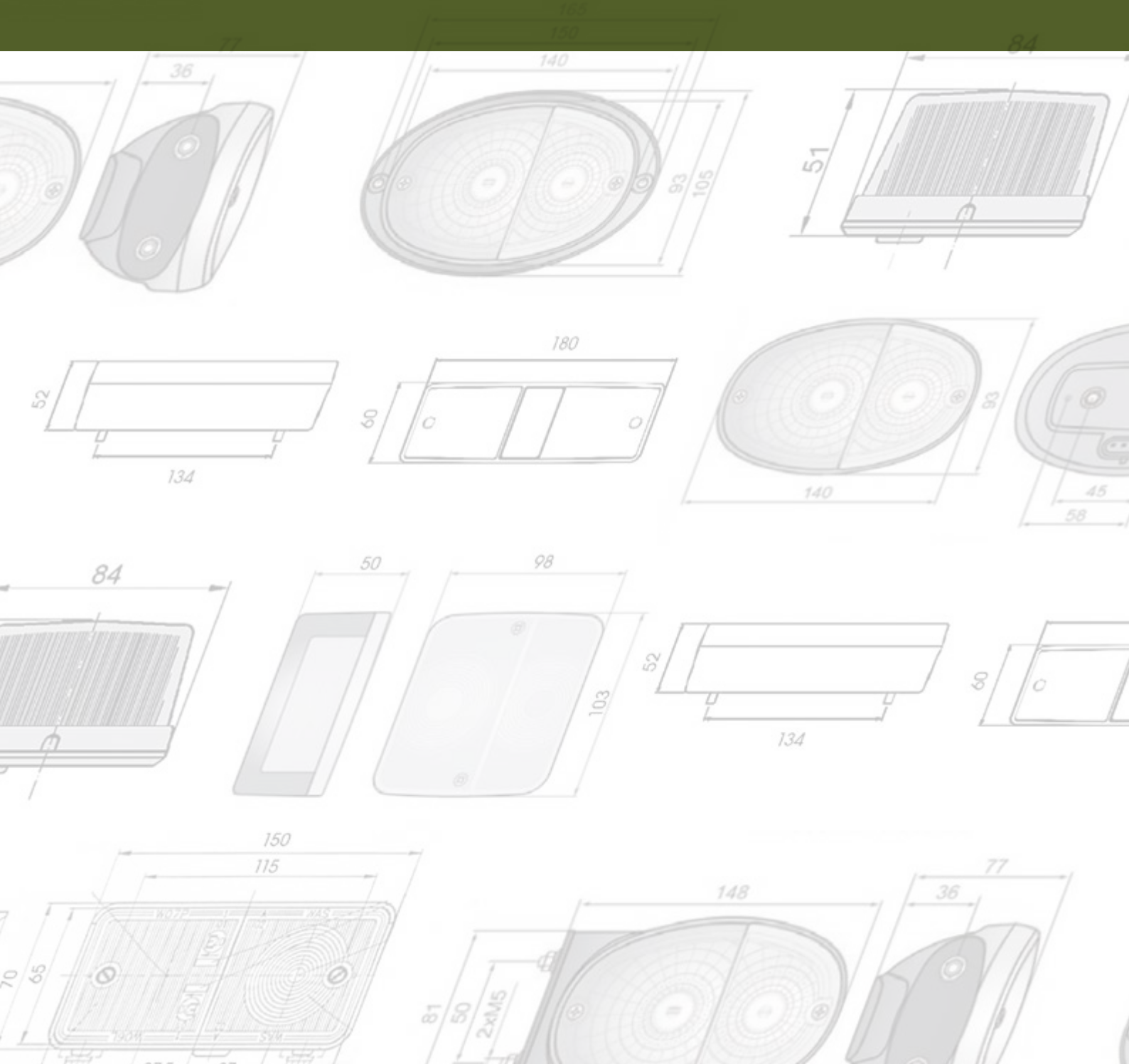

PŘEDNÍ POZIČNÍ SVÍTLNÝ / FRONT POSITION LAMP / VORDERE POSITIONLEUCHE / ПЕРЕДНЕГО УКАЗАТЕЛЯ ПОВОРОТА

KÓD / ORDER CODE / BESTELL NR. / КОД		POPIS / DESCRIPTION/ BESCHREIBUNG / ОПИСАНИЕ	OE / OE NUMBER / OE NUMBER / OE
727123	 	<p>IP 54 E</p> <ul style="list-style-type: none"> ■ Rozměr: 84x84 mm, směrová a poziční svítlna ■ Dimensions: 84x84 mm, flasher and pos. lamp ■ Das mass: 84x84 mm, blink und Positionlamp ■ Размеры: 84x84 mm, Направление и положение лампы 	2BE003014-251 03.387.000.01 1011736

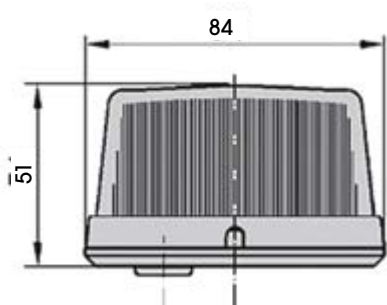

722950	12V	C5W 12V, SV 8.5-8
722931	12V	P21W 12V, BA15s
722951	24V	C5W 24V, SV8.5-8
722932	24V	P21W 24V, BA15s

Kryt / Lens / Lichtscheibe / Крышка

727124		9EL115003-055 03.387.100.01 043 65083
--------	--	---

KÓD / ORDER CODE / BESTELL NR. / КОД		POPIS / DESCRIPTION/ BESCHREIBUNG / ОПИСАНИЕ	OE / OE NUMBER / OE NUMBER / OE
720264		<p>IP 54 E</p> <ul style="list-style-type: none"> ■ Rozměr: 103x98 mm, směrová a poziční svítlna ■ Dimensions: 103x98 mm, flasher and position lamp ■ Das mass: 103x98 mm, blink und Positionlamp ■ Размеры: 103x98 mm, Направление и положение лампы 	

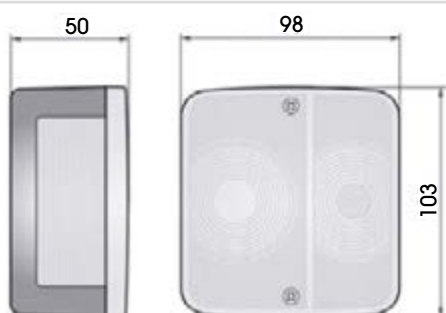

722937	12V	P21 5W 12V, BAY15d
722940	12V	R5W 12V, BA15s
722938	24V	P21 5W 24V, BAY15d
722941	24V	R5W 24V, BA15s

Kryt / Lens / Lichtscheibe / Крышка

720262		
--------	---	--

PŘEDNÍ POZIČNÍ SVÍTLILNY / FRONT POSITION LAMP / VORDERE POSITIONLEUCHTE / ПЕРЕДНЕГО УКАЗАТЕЛЯ ПОВОРОТА

KÓD / ORDER CODE / BESTELL NR. / КОД	POPIS / DESCRIPTION / BESCHREIBUNG / ОПИСАНИЕ	OE / OE NUMBER / OE NUMBER / OE														
722220	 <p>E</p> <ul style="list-style-type: none"> Uchycení: 2x matice + šroub M6 Mounting: 2x screw + nut M6 Montage: 2x schraube + mutter M6 Крепление: 2 гайки + болты M6 															
 <p>52 134 60 180</p>	<table border="1"> <tr> <td>722937</td> <td>12V</td> <td>P21 5W 12V, BAY15d</td> </tr> <tr> <td>722940</td> <td>12V</td> <td>R5W 12V, BA15s</td> </tr> <tr> <td>722938</td> <td>24V</td> <td>P21 5W 24V, BAY15d</td> </tr> <tr> <td>722941</td> <td>24V</td> <td>R5W 24V, BA15s</td> </tr> </table> <p>Kryt / Lens / Lichtscheibe / Крышка</p> <table border="1"> <tr> <td>722223</td> <td></td> </tr> </table>	722937	12V	P21 5W 12V, BAY15d	722940	12V	R5W 12V, BA15s	722938	24V	P21 5W 24V, BAY15d	722941	24V	R5W 24V, BA15s	722223		
722937	12V	P21 5W 12V, BAY15d														
722940	12V	R5W 12V, BA15s														
722938	24V	P21 5W 24V, BAY15d														
722941	24V	R5W 24V, BA15s														
722223																

KÓD / ORDER CODE / BESTELL NR. / КОД	POPIS / DESCRIPTION / BESCHREIBUNG / ОПИСАНИЕ	OE / OE NUMBER / OE NUMBER / OE														
<p>727182 PRAVÁ / RIGHT / RECHTS / ПРАВАЯ</p> <p>727183 LEVÁ / LEFT / LINKS / ЛЕВАЯ</p>	 <p>12-24 V IP 54</p> <ul style="list-style-type: none"> Uchycení: 2x matice + šroub M6 Mounting: 2x screw + nut M6 Montage: 2x schraube + mutter M6 Крепление: 2 гайки + болты M6 															
 <p>M6 70 65 150 115 27.5 37 110 145 18 77</p>	<table border="1"> <tr> <td>722931</td> <td>12V</td> <td>P21W 12V, BA15s</td> </tr> <tr> <td>722940</td> <td>12V</td> <td>R5W 12V, BA15s</td> </tr> <tr> <td>722932</td> <td>24V</td> <td>P21W 24V, BA15s</td> </tr> <tr> <td>722941</td> <td>24V</td> <td>R5W 24V, BA15s</td> </tr> </table> <p>Kryt / Lens / Lichtscheibe / Крышка</p> <table border="1"> <tr> <td>727179</td> <td></td> </tr> </table>	722931	12V	P21W 12V, BA15s	722940	12V	R5W 12V, BA15s	722932	24V	P21W 24V, BA15s	722941	24V	R5W 24V, BA15s	727179		
722931	12V	P21W 12V, BA15s														
722940	12V	R5W 12V, BA15s														
722932	24V	P21W 24V, BA15s														
722941	24V	R5W 24V, BA15s														
727179																

Important notice: part of other producers are only mentioned for comparison purposes.

PŘEDNÍ POZIČNÍ SVÍTLNÝ / FRONT POSITION LAMP / VORDERE POSITIONLEUCHE / ПЕРЕДНЕГО УКАЗАТЕЛЯ ПОВОРОТА

KÓD / ORDER CODE / BESTELL NR. / КОД	ZETOR: Major UŘ I 1984 - 1993, 1997 - 2004, 1992 - 2006, Forterra 2007	POPIS / DESCRIPTION / BESCHREIBUNG / ОПИСАНИЕ	OE / OE NUMBER / OE NUMBER / OE
726887		<p>IP 55 </p> <ul style="list-style-type: none"> ■ Uchycení: 2x matice + šroub M5 ■ Mounting: 2x screw + nut M5 ■ Montage: 2x schraube + mutter M5 ■ Крепление: 2 гайки + болты M5 	443312184104 16.351.039 15.351.039 16.351.049 15.351.049 78.351.549

722940	12V	R5W 12V, BA15s
722931	12V	P21W 12V, BA15s

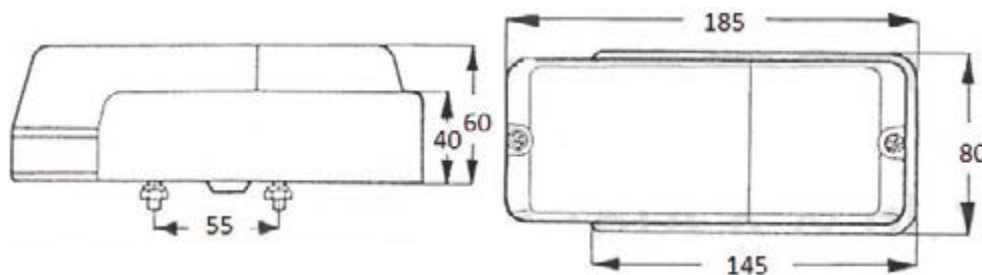

KÓD / ORDER CODE / BESTELL NR. / КОД	ZETOR: Major 1977 - 1980, 1984 - 1993	POPIS / DESCRIPTION / BESCHREIBUNG / ОПИСАНИЕ	OE / OE NUMBER / OE NUMBER / OE
726888		<p>IP 55 </p> <ul style="list-style-type: none"> ■ Uchycení: 2x matice + šroub M5 ■ Mounting: 2x screw + nut M5 ■ Montage: 2x schraube + mutter M5 ■ Крепление: 2 гайки + болты M5 	6011-5805/8 6011-5805 6711-5710

722940	12V	R5W 12V, BA15s
722931	12V	P21W 12V, BA15s

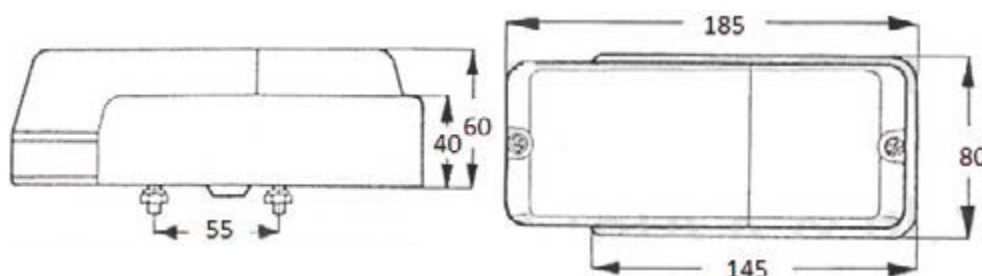

PŘEDNÍ POZIČNÍ SVÍTLILNY / FRONT POSITION LAMP / VORDERE POSITIONLEUCHTE / ПЕРЕДНЕГО УКАЗАТЕЛЯ ПОВОРОТА

KÓD / ORDER CODE / BESTELL NR. / КОД	CLASS, DEUTZ - FAHR	POPIS / DESCRIPTION/ BESCHREIBUNG / ОПИСАНИЕ	OE / OE NUMBER / OE NUMBER / OE
720554	 	<p></p> <ul style="list-style-type: none"> Uchycení: 2x matice + šroub M5 Mounting: 2x screw + nut M5 Montage: 2x schraube + mutter M5 Крепление: 2 гайки + болты M5 	1011301

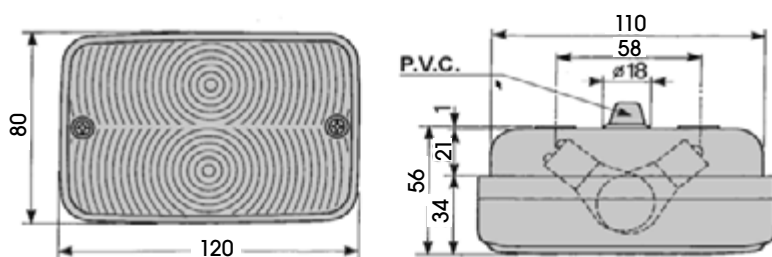

722931	12V	P21W 12V, BA15s
722940	12V	R5W 12V, BA15s
722932	24V	P21W 24V, BA15s
722941	24V	R5W 24V, BA15s

Kryt / Lens / Lichtscheibe / Крышка

720557



KÓD / ORDER CODE / BESTELL NR. / КОД	CLASS, DEUTZ - FAHR	POPIS / DESCRIPTION/ BESCHREIBUNG / ОПИСАНИЕ	OE / OE NUMBER / OE NUMBER / OE
720554/N		<p></p> <ul style="list-style-type: none"> Uchycení: 2x matice + šroub M5 Mounting: 2x screw + nut M5 Montage: 2x schraube + mutter M5 Крепление: 2 гайки + болты M5 	

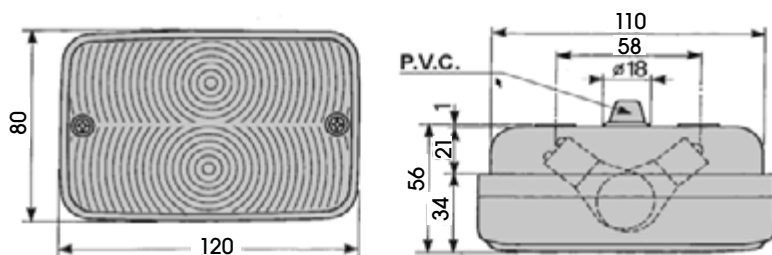

722931	12V	P21W 12V, BA15s
722940	12V	R5W 12V, BA15s
722932	24V	P21W 24V, BA15s
722941	24V	R5W 24V, BA15s

Kryt / Lens / Lichtscheibe / Крышка

720557/N



PŘEDNÍ POZIČNÍ SVÍTLILNY / FRONT POSITION LAMP / VORDERE POSITIONLEUCHE / ПЕРЕДНЕГО УКАЗАТЕЛЯ ПОВОРОТА

KÓD / ORDER CODE / BESTELL NR. / КОД	ZETOR: Major 80, Proxima, Forterra, Crystal	POPIS / DESCRIPTION/ BESCHREIBUNG / ОПИСАНИЕ	OE / OE NUMBER / OE NUMMER / OE
724616 PRAVÁ / RIGHT / RECHTS / ПРАВЯЯ		<p>IP 55 E</p> <ul style="list-style-type: none"> Uchycení: 2x matice + šroub M5, kabel 1,5 m Mounting: 2x screw + nut M5, cable 1,5 m Montage: 2x schraube + mutter M5, kabel 1,5 m Крепление: 2 гайки + болты M5, кабель 1,5 м 	03.0665.0000 19.351.909
724617 LEVÁ / LEFT / LINKS / ЛЕВАЯ			03.0666.0000 19.351.908

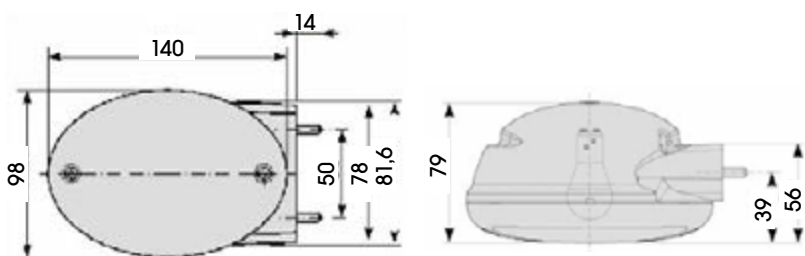

722931	12V	P21W 12V, BA15s
722940	12V	R5W 12V, BA15s
722932	24V	P21W 24V, BA15s
722941	24V	R5W 24V, BA15s

Kryt / Lens / Lichtscheibe / Крышка

724618		03.0665.0200
--------	--	--------------

KÓD / ORDER CODE / BESTELL NR. / КОД	ZETOR: Major 80, Proxima, Forterra, Crystal	POPIS / DESCRIPTION/ BESCHREIBUNG / ОПИСАНИЕ	OE / OE NUMBER / OE NUMMER / OE
724687		<p>E</p> <ul style="list-style-type: none"> Uchycení: 2x matice + šroub M6 Mounting: 2x screw + nut M6 Montage: 2x schraube + mutter M6 Крепление: 2 гайки + болты M6 	2BE343130-411 AG630090

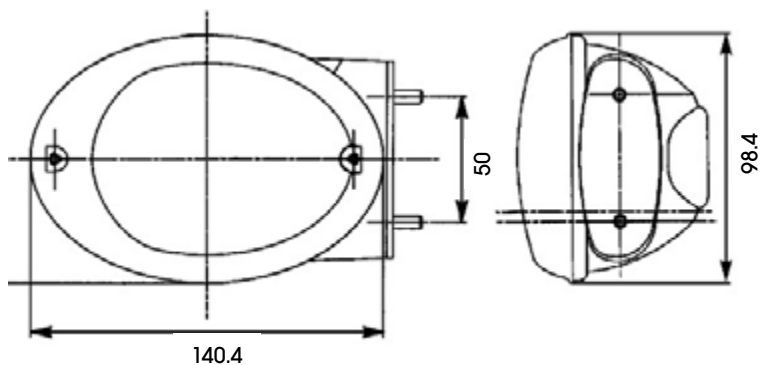

722931	12V	P21W 12V, BA15s
722943	12V	R10W 12V, BA15s
722932	24V	P21W 24V, BA15s
722944	24V	R10W 24V, BA15s

PŘEDNÍ POZIČNÍ SVÍTLILNY / FRONT POSITION LAMP / VORDERE POSITIONLEUCHTE / ПЕРЕДНЕГО УКАЗАТЕЛЯ ПОВОРОТА

KÓD / ORDER CODE / BESTELL NR. / КОД	ZETOR: Major 80, Proxima, Forterra, CLASS	POPIS / DESCRIPTION/ BESCHREIBUNG / ОПИСАНИЕ	OE / OE NUMBER / OE NUMBER / OE
726815	 	<p>E</p> <ul style="list-style-type: none"> Uchycení: 2x matice + šroub M6 Mounting: 2x screw + nut M6 Montage: 2x schraube + mutter M6 Крепление: 2 гайки + болты M6 	2BE343130-001

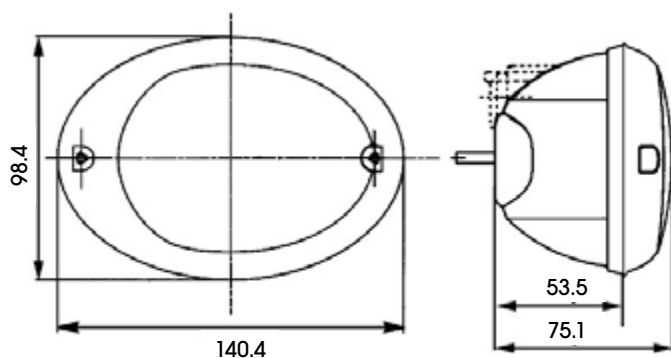

722931	12V	P21W 12V, BA15s
722943	12V	R10W 12V, BA15s
722932	24V	P21W 24V, BA15s
722944	24V	R10W 24V, BA15s

Průchodka / Grommet / Verschraubung / Прокладка

724360



KÓD / ORDER CODE / BESTELL NR. / КОД	ZETOR: Major 80, Proxima, Forterra, crystal	POPIS / DESCRIPTION/ BESCHREIBUNG / ОПИСАНИЕ	OE / OE NUMBER / OE NUMBER / OE
724614		<p>IP 55 E</p> <ul style="list-style-type: none"> Uchycení: 2x Matice + šroub M5 Mounting: 2x screw + nut M5 Montage: 2x schraube + mutter M5 Крепление: 2 гайки + болты M5 	

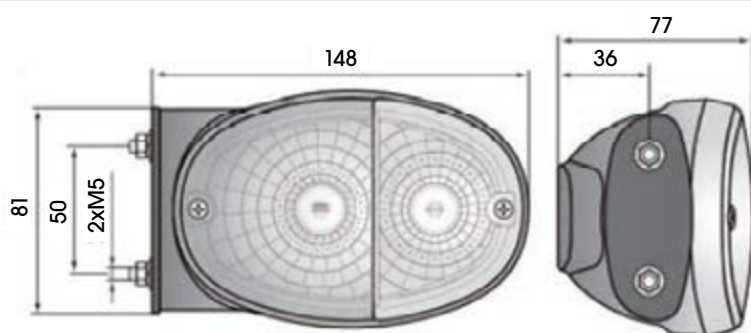

722940	12V	R5W 12V, BA15s
722931	12V	P21W 12V, BA15s
722941	24V	R5W 24V, BA15s
722932	24V	P21W 24V, BA15s

PŘEDNÍ POZIČNÍ SVÍTLNÝ / FRONT POSITION LAMP / VORDERE POSITIONLEUCHE / ПЕРЕДНЕГО УКАЗАТЕЛЯ ПОВОРОТА

KÓD / ORDER CODE / BESTELL NR. / КОД	ZETOR: Major HS 80	POPIS / DESCRIPTION/ BESCHREIBUNG / ОПИСАНИЕ	OE / OE NUMBER / OE NUMMER / OE
724613		<p>IP 55 </p> <ul style="list-style-type: none"> ■ Rozteč šroubů: 150 mm ■ Screws pitch: 150 mm ■ Schrauben Tonhöhe: 150 mm ■ винты основного тона: 150 mm 	

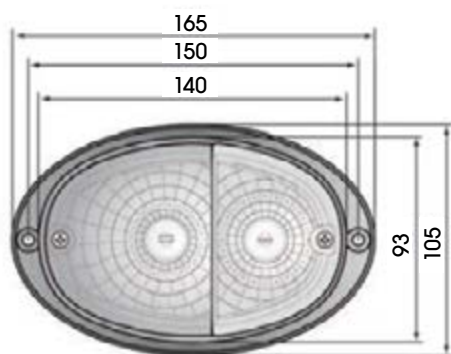

722940	12V	R5W 12V, BA15s
722931	12V	P21W 12V, BA15s
722941	24V	R5W 24V, BA15s
722932	24V	P21W 24V, BA15s

Opravná sada / Repair kit / Abschlussatz / Ремонтный комплект

721032	
721059	

KÓD / ORDER CODE / BESTELL NR. / КОД	ZETOR: Major 80, Proxima, Forterra, CLASS	POPIS / DESCRIPTION/ BESCHREIBUNG / ОПИСАНИЕ	OE / OE NUMBER / OE NUMMER / OE
724612		<p>IP 55 </p> <ul style="list-style-type: none"> ■ Uchycení: 2x matice + šroub M5 ■ Mounting: 2x screw + nut M5 ■ Montage: 2x schraube + mutter M5 ■ Крепление: 2 гайки + болты M5 	

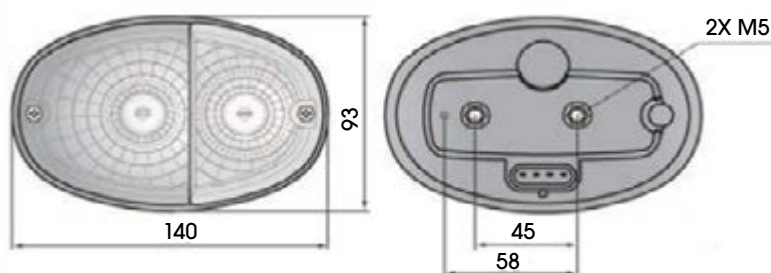



722940	12V	R5W 12V, BA15s
722931	12V	P21W 12V, BA15s
722941	24V	R5W 24V, BA15s
722932	24V	P21W 24V, BA15s

Opravná sada / Repair kit / Abschlussatz / Ремонтный комплект

721032	
--------	---

**PŘEDNÍ POZIČNÍ SVÍTILNY / FRONT POSITION LAMP /
VORDERE POSITIONLEUCHE / ПЕРЕДНЕГО УКАЗАТЕЛЯ ПОВОРОТА**

KÓD / ORDER CODE / BESTELL NR. / КОД	LIEBHERR	POPIS / DESCRIPTION/ BESCHREIBUNG / ОПИСАНИЕ	OE / OE NUMBER / OE NUMBER / OE
721275	 	<p></p> <ul style="list-style-type: none"> Uchycení: 2x matice + šroub M6 Mounting: 2x screw + nut M6 Montage: 2x schraube + mutter M6 Крепление: 2 гайки + болты M6 	2BE964169-071 6004450 607149908

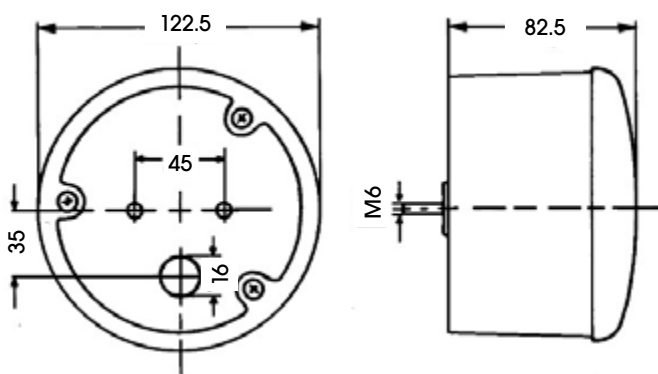

722931	12V	P21W 12V, BA15s
722940	12V	R5W 12V, BA15s
722932	24V	P21W 24V, BA15s
722941	24V	R5W 24V, BA15s

Kryt / Lens / Lichtscheibe / Крышка

721276	
--------	--

KÓD / ORDER CODE / BESTELL NR. / КОД	JOHN DEERE, HOLDER, STEYR	POPIS / DESCRIPTION/ BESCHREIBUNG / ОПИСАНИЕ	OE / OE NUMBER / OE NUMBER / OE
722304	 	<p></p> <ul style="list-style-type: none"> Uchycení: 2x Matice + šroub M6 Mounting: 2x screw + nut M6 Montage: 2x Schraube + Mutter M6 Крепление: 2 гайки + болты M6 	2BE003185-031 1526004 148301 05722006 189.73.0029

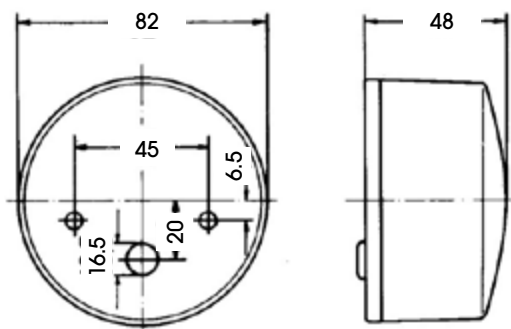



722931	12V	P21W 12V, BA15s
722950	12V	C5W 12V, SV8,5-8
722932	24V	P21W 24V, BA15s
722950	24V	C5W 24V, SV8,5-8

Kryt / Lens / Lichtscheibe / Крышка

722305	
--------	---

PŘEDNÍ POZIČNÍ SVÍTLNÝ / FRONT POSITION LAMP / VORDERE POSITIONLEUCHE / ПЕРЕДНЕГО УКАЗАТЕЛЯ ПОВОРОТА

KÓD / ORDER CODE / BESTELL NR. / КОД	JOHN DEERE, FENDT, STEYR, LIEBHERR, KRAMER	POPIS / DESCRIPTION / BESCHREIBUNG / ОПИСАНИЕ	OE / OE NUMBER / OE NUMBER / OE
728941 PRAVÁ / RIGHT / RECHTS / ПРАВАЯ	 	<p>IP 55 </p> <ul style="list-style-type: none"> Uchycení: 2x matice + šroub M6 Mounting: 2x screw + nut M6 Montage: 2x schraube + mutter M6 Крепление: 2 гайки + болты M6 	2BE003182-101
728942 LEVÁ / LEFT / LINKS / ЛЕВАЯ			2BE003182-091

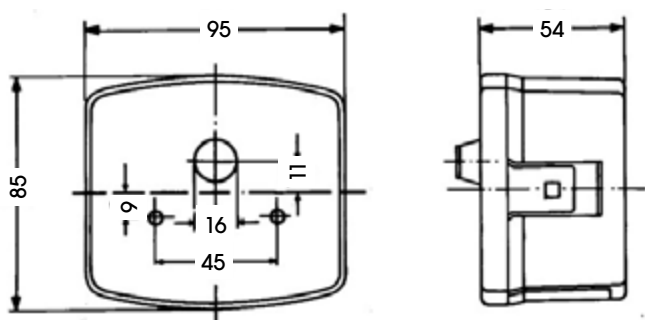

722931	12V	P21W 12V, BA15s
722950	12V	C5W 12V, SV8,5-8
722932	24V	P21W 24V, BA15s
722950	24V	C5W 24V, SV8,5-8

Kryt / Lens / Lichtscheibe / Крышка

728943	
--------	---

KÓD / ORDER CODE / BESTELL NR. / КОД	KUBOTA	POPIS / DESCRIPTION / BESCHREIBUNG / ОПИСАНИЕ	OE / OE NUMBER / OE NUMBER / OE
722234 PRAVÁ / RIGHT / RECHTS / ПРАВАЯ	 	<p></p> <ul style="list-style-type: none"> Uchycení: 2x šroub Mounting: 2x screw Montage: 2x Schraube Крепление: 2 гайки 	2BE003184-061 1487446 TA04934200 7701366010 1092
722235 LEVÁ / LEFT / LINKS / ЛЕВАЯ			2BE003184-051 1489041 7701366011 1091

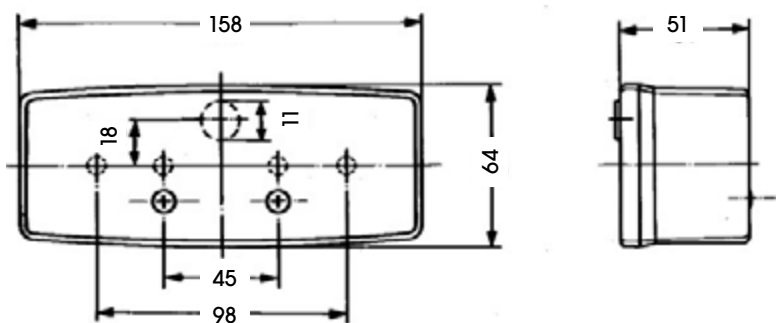

722931	12V	P21W 12V, BA15s
722940	12V	R5W 12V, BA15s
722932	24V	P21W 24V, BA15s
722941	24V	R5W 24V, BA15s

Kryt / Lens / Lichtscheibe / Крышка

722236	Pravá / Right / Rechts / правая	
722237	Levá / Left / Links / левая	

PŘEDNÍ POZIČNÍ SVÍTLILNY / FRONT POSITION LAMP / VORDERE POSITIONLEUCHTE / ПЕРЕДНЕГО УКАЗАТЕЛЯ ПОВОРОТА

KÓD / ORDER CODE / BESTELL NR. / КОД		POPIS / DESCRIPTION/ BESCHREIBUNG / ОПИСАНИЕ	OE / OE NUMBER / OE NUMBER / OE
727158 PRAVÁ / RIGHT / RECHTS / ПРАВАЯ	 	<p>E</p> <ul style="list-style-type: none"> Uchycení: 2x matice + šroub M5, pracovní světlo, kabel 0,3 m Mounting: 2x screw + nut M5, work lamp, cable 0,3 m Montage: 2x schraube + mutter M5, arbeitsscheinwerfer, kable 0,3 m Крепление: 2 гайки + болты M5, рабочее освещение, кабель 0,3 м 	03.0676.0000
727157 LEVÁ / LEFT / LINKS / ЛЕВАЯ			03.0677.0000

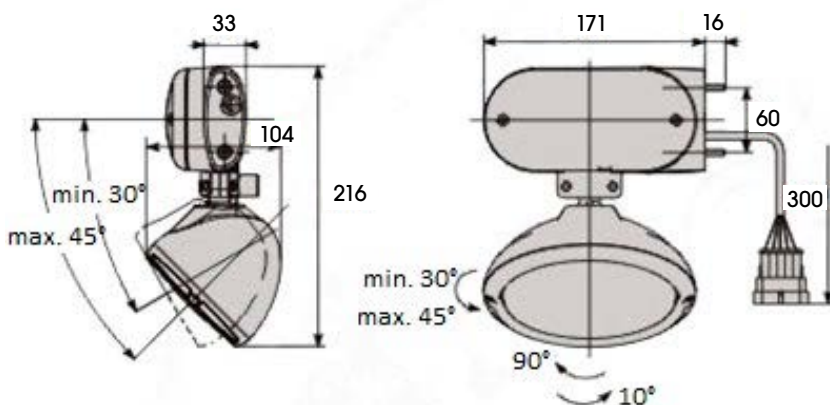

722909	12V	H3 12V 55W, PK22s
722934	12V	PY21W 12V, BAU15s
722940	12V	R5W 12V, BA15s
722910	24V	H3 24V 70W, PK22s
722935	24V	PY21W 24V, BAU15s
722941	24V	R5W 24V, BA15s



Kryt / Lens / Lichtscheibe / Крышка

727164		
--------	--	---

Opravná sada / Repair kit / Abschlussatz / Ремонтный комплект

721032		
--------	--	---

PŘEDNÍ POZIČNÍ SVÍTLILNY / FRONT POSITION LAMP / VORDERE POSITIONLEUCHE / ПЕРЕДНЕГО УКАЗАТЕЛЯ ПОВОРОТА

KÓD / ORDER CODE / BESTELL NR. / КОД	CASE, STEYR, LINDNER	POPIS / DESCRIPTION/ BESCHREIBUNG / ОПИСАНИЕ	OE / OE NUMBER / OE NUMBER / OE
727163 PRAVÁ / RIGHT / RECHTS / ПРАВАЯ	 	 <ul style="list-style-type: none"> Uchyceni: 2x matice + šroub M5 Mounting: 2x screw + nut M5 Montage: 2x schraube + mutter M5 Крепление: 2 гайки + болты M5 	03.0629.0000
727162 LEVÁ / LEFT / LINKS / ЛЕВАЯ			03.0628.0000

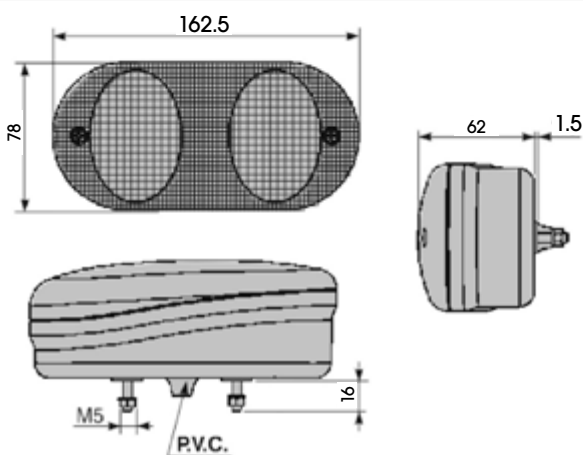

722934	12V	PY21W 12V, BAU15s
722940	12V	R5W 12V, BA15s
722935	24V	PY21W 24V, BAU15s
722941	24V	R5W 24V, BA15s

Kryt / Lens / Lichtscheibe / Крышка

727164	
--------	--

KÓD / ORDER CODE / BESTELL NR. / КОД	NEW HOLLAND, STEYR	POPIS / DESCRIPTION/ BESCHREIBUNG / ОПИСАНИЕ	OE / OE NUMBER / OE NUMBER / OE
727160 PRAVÁ / RIGHT / RECHTS / ПРАВАЯ	 	 <ul style="list-style-type: none"> Uchyceni: tyč, kabel 1 m Mounting: tube, cable 1 m Montage: auf Rohr, kabel 1 m Крепление: трубка, кабель 1 м 	03.0557.0000
727159 LEVÁ / LEFT / LINKS / ЛЕВАЯ			03.0558.0000

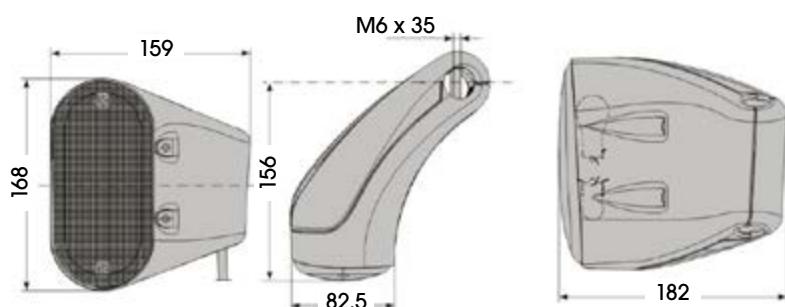

722934	12V	PY21W 12V, BAU15s
722940	12V	R5W 12V, BA15s
722935	24V	PY21W 24V, BAU15s
722941	24V	R5W 24V, BA15s

Kryt / Lens / Lichtscheibe / Крышка

727161	
--------	---

PŘEDNÍ POZIČNÍ SVÍTLILNY / FRONT POSITION LAMP / VORDERE POSITIONLEUCHTE / ПЕРЕДНЕГО УКАЗАТЕЛЯ ПОВОРОТА

KÓD / ORDER CODE / BESTELL NR. / КОД		POPIS / DESCRIPTION/ BESCHREIBUNG / ОПИСАНИЕ	OE / OE NUMBER / OE NUMBER / OE
724698	 	<p></p> <ul style="list-style-type: none"> Uchycení: 2x matice + šroub M5 Mounting: 2x screw + nut M5 Montage: 2x schraube + mutter M5 Крепление: 2 гайки + болты M5 	03.0767.0000

722934	12V	PY21W 12V, BAU15s
722940	12V	R5W 12V, BA15s
722935	24V	PY21W 24V, BAU15s
722941	24V	R5W 24V, BA15s

Kryt / Lens / Lichtscheibe / Крышка

727161



KÓD / ORDER CODE / BESTELL NR. / КОД	ZETOR: Proxima, Forterra	POPIS / DESCRIPTION/ BESCHREIBUNG / ОПИСАНИЕ	OE / OE NUMBER / OE NUMBER / OE
728392 PRAVÁ / RIGHT / RECHTS / ПРАВАЯ		<p> </p> <ul style="list-style-type: none"> Uchycení: 2x matice + šroub M6 Mounting: 2x screw + nut M6 Montage: 2x schraube + mutter M6 Крепление: 2 гайки + болты M6 	93-5574
728393 LEVÁ / LEFT / LINKS / ЛЕВАЯ			93-5575

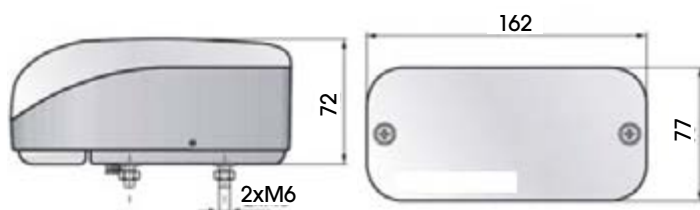

722934	12V	PY21W 12V, BAU15s
722940	12V	R5W 12V, BA15s
722935	24V	PY21W 24V, BAU15s
722941	24V	R5W 24V, BA15s

ZADNÍ SKUPINOVÉ SVÍTILNY / REAR LAMPS / HECKLEUCHTEN / ЗАДНИЕ ФОНАРИ



SMĚROVÁ A POZIČNÍ SVÍTILNA / INDICATOR AND POSITION LAMP / BLINK UND POSITION LAMP / НАПРАВЛЕНИЕ И ПОЛОЖЕНИЕ ЛАМПЫ

IP 54

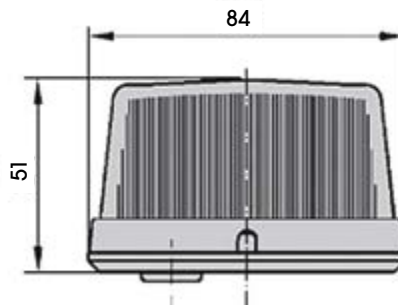

KÓD / ORDER CODE / BESTELL NR. / КОД	OE / OE NUMBER / OE NUMMER / OE	PRAVÁ / RIGHT / RECHTS / ПРАВАЯ	LEVÁ / LEFT / LINKS / ЛЕВАЯ	OSVĚTLENÍ SPZ / ILLUMINATION FOR NUMBERPLATE / KENNZEICHENLEUCHE / ПОДСВЕТКА НОМЕРНОГО ЗНАКА	PŘIPOJENÍ / CONNECTION / ANSCHLUSS / СОЕДИНЕНИЕ	
727125	03.483.000.01	■	■			
727126 KRYT / LENS / LICHTSCHEIBE / КРЫШКА	03.483.001	■	■			
				722950	12V	C5W 12V, SV8.5-8
				722931	12V	P21W 12V, BA15s
				722951	24V	C5W 24V, SV8.5-8
				722932	24V	P21W 24V, BA15s



POZIČNÍ SVÍTILNA / POSITION LAMP / POSITION LAMP / ПОЛОЖЕНИЕ ЛАМПЫ

IP 54

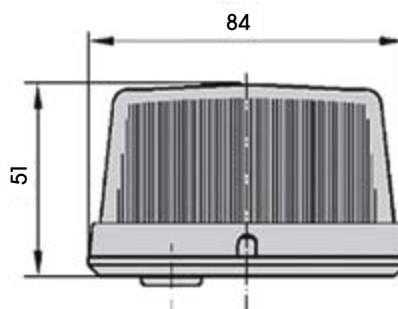

KÓD / ORDER CODE / BESTELL NR. / КОД	OE / OE NUMBER / OE NUMMER / OE	PRAVÁ / RIGHT / RECHTS / ПРАВАЯ	LEVÁ / LEFT / LINKS / ЛЕВАЯ	OSVĚTLENÍ SPZ / ILLUMINATION FOR NUMBERPLATE / KENNZEICHENLEUCHE / ПОДСВЕТКА НОМЕРНОГО ЗНАКА	PŘIPOJENÍ / CONNECTION / ANSCHLUSS / СОЕДИНЕНИЕ	
727129	25B003014-151	■	■			
				722950	12V	C5W 12V, SV8.5-8
				722931	12V	P21W 12V, BA15s
				722951	24V	C5W 24V, SV8.5-8
				722932	24V	P21W 24V, BA15s

ZADNÍ SKUPINOVÉ SVÍTILNY / REAR LAMPS / HECKLEUCHTEN / ЗАДНИЕ ФОНАРИ



**2 KOMOROVÉ KONCOVÉ - BRZDOVÉ - SMĚROVÉ / 2-CHAMBER LIGHT TAIL - STOP - FLASHER LAMP /
2-KAMMER LEUCHTE SCHLUSS - BREMS - BLINKLEUCHTE /
2-ФУНКЦИОНАЛЬНАЯ ЗАДНЯЯ ФАРА - ЛАМПА СИГНАЛА СТОП/ТОРМАЖЕНИЯ - УКАЗАТЕЛЬ ПОВОРОТА**

IP 55

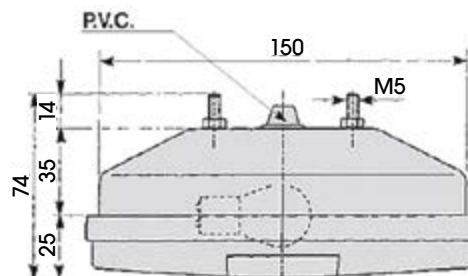

KÓD / ORDER CODE / BESTELL NR. / КОД	OE / OE NUMBER / OE NUMBER / OE	PRAVÁ / RIGHT / RECHTS / ПРАВАЯ	LEVÁ / LEFT / LINKS / ЛЕВАЯ	OSVĚTLENÍ SPZ / ILLUMINATION FOR NUMBERPLATE / KENNZEICHENLEUCHTE / ПОДСВЕТКА НОМЕРНОГО ЗНАКА	PŘIPOJENÍ / CONNECTION / ANSCHLUSS / СОЕДИНЕНИЕ	
725279	02.748.000.01	■	■		Kabel- 0,1 m Cabel- 0,1 m Kabel- 0,1 m Кабель - 0,1 м	
720348 KRYT / LENS / LICHTSCHEIBE / КРЫШКА	02.728.210.01	■	■			
				722937	12V	P21 5W 12V, BAY15d
				722931	12V	P21W 12V, BA15s
				722938	24V	P21 5W 24V, BAY15d
				722932	24V	P21W 24V, BA15s



**2 KOMOROVÉ KONCOVÉ - BRZDOVÉ - SMĚROVÉ / 2-CHAMBER LIGHT TAIL - STOP - FLASHER LAMP /
2-KAMMER LEUCHTE SCHLUSS - BREMS - BLINKLEUCHTE /
2-ФУНКЦИОНАЛЬНАЯ ЗАДНЯЯ ФАРА - ЛАМПА СИГНАЛА СТОП/ТОРМАЖЕНИЯ - УКАЗАТЕЛЬ ПОВОРОТА**

IP 55

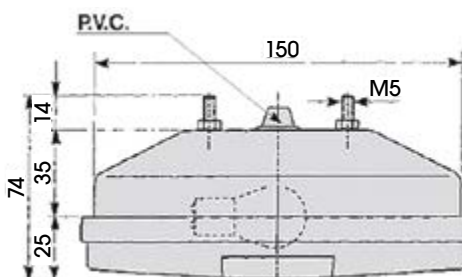

KÓD / ORDER CODE / BESTELL NR. / КОД	OE / OE NUMBER / OE NUMBER / OE	PRAVÁ / RIGHT / RECHTS / ПРАВАЯ	LEVÁ / LEFT / LINKS / ЛЕВАЯ	OSVĚTLENÍ SPZ / ILLUMINATION FOR NUMBERPLATE / KENNZEICHENLEUCHTE / ПОДСВЕТКА НОМЕРНОГО ЗНАКА	PŘIPOJENÍ / CONNECTION / ANSCHLUSS / СОЕДИНЕНИЕ	
720347	02.728.000.01	■	■			
720348 KRYT / LENS / LICHTSCHEIBE / Крышка	02.728.210.01	■	■			
				722937	12V	P21 5W 12V, BAY15d
				722931	12V	P21W 12V, BA15s
				722938	24V	P21 5W 24V, BAY15d
				722932	24V	P21W 24V, BA15s

ZADNÍ SKUPINOVÉ SVÍTILNY / REAR LAMPS / HECKLEUCHTEN / ЗАДНИЕ ФОНАРИ



2 KOMOROVÉ KONCOVÉ – BRZDOVÉ – SMĚROVÉ / 2-CHAMBER LIGHT TAIL – STOP – FLASHER LAMP /
2-KAMMER LEUCHTE SCHLUSS – BREMS – BLINKLEUCHTE /
2-ФУНКЦИОНАЛЬНАЯ ЗАДНЯЯ ФАРА – ЛАМПА СИГНАЛА СТОП/ТОРМАЖЕНИЯ – УКАЗАТЕЛЬ ПОВОРОТА

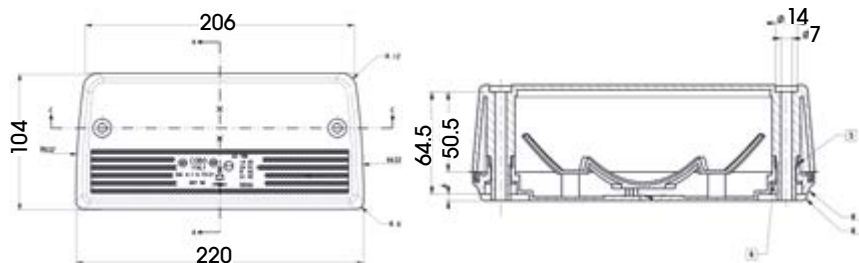

KÓD / ORDER CODE / BESTELL NR. / КОД	OE / OE NUMBER / OE NUMMER / OE	PRAVÁ / RIGHT / RECHTS / ПРАВАЯ	LEVÁ / LEFT / LINKS / ЛЕВАЯ	OSVĚTLENÍ SPZ / ILLUMINATION FOR NUMBERPLATE / KENNZEICHENLEUCHTE / ПОДСВЕТКА НОМЕРНОГО ЗНАКА	PŘIPOJENÍ / CONNECTION / ANSCHLUSS / СОЕДИНЕНИЕ
722972	02.780.000.01	■	■		
				722937	12V P21 5W 12V, BAY15d
				722931	12V P21W 12V, BA15s
				722938	24V P21 5W 24V, BAY15d
				722932	24V P21W 24V, BA15s

ZADNÍ SKUPINOVÉ SVÍTILNY / REAR LAMPS / HECKLEUCHTEN / ЗАДНИЕ ФОНАРИ

**3 KOMOROVÉ KONCOVÉ - BRZDOVÉ - SMĚROVÉ / 3-CHAMBER LIGHT TAIL - STOP - FLASHER LAMP /
3-KAMMER LEUCHE SCHLUSS - BREMS - BLINKLEUCHE /
3-ФУНКЦИОНАЛЬНАЯ ЗАДНЯЯ ФАРА - ЛАМПА СИГНАЛА СТОП/ТОРМАЖЕНИЯ - УКАЗАТЕЛЬ ПОВОРОТА**

IP 55

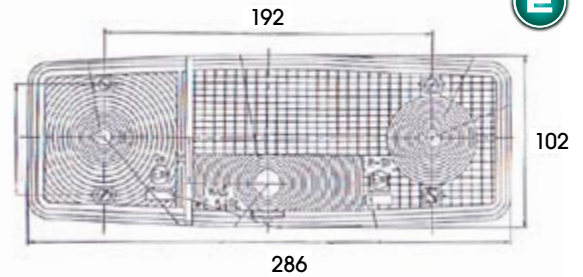

KÓD / ORDER CODE / BESTELL NR. / КОД	OE / OE NUMBER / OE NUMMER / OE	PRAVÁ / RIGHT / RECHTS / ПРАВАЯ	LEVÁ / LEFT / LINKS / ЛЕВАЯ	OSVĚTLENÍ SPZ / ILLUMINATION FOR NUMBERPLATE / KENNZEICHENLEUCHE / ПОДСВЕТКА НОМЕРНОГО ЗНАКА	PŘIPOJENÍ / CONNECTION / ANSCHLUSS / СОЕДИНЕНИЕ	
722252		■				
722253			■			
722254 KRYT / LENS / LICHTSCHEIBE / КРЫШКА		■				
722255 KRYT / LENS / LICHTSCHEIBE / КРЫШКА			■			
				722943	12V	R10W 12V, BA15s
				722931	12V	P21W 12V, BA15s
				722944	24V	R10W 24V, BA15s
				722932	24V	P21W 24V, BA15s



**2 KOMOROVÉ KONCOVÉ - BRZDOVÉ - SMĚROVÉ / 2-CHAMBER LIGHT TAIL - STOP - FLASHER LAMP /
2-KAMMER LEUCHE SCHLUSS - BREMS - BLINKLEUCHE /
2-ФУНКЦИОНАЛЬНАЯ ЗАДНЯЯ ФАРА - ЛАМПА СИГНАЛА СТОП/ТОРМАЖЕНИЯ - УКАЗАТЕЛЬ ПОВОРОТА**

IP 56

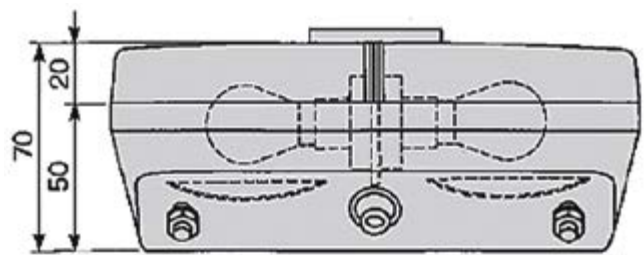

KÓD / ORDER CODE / BESTELL NR. / КОД	OE / OE NUMBER / OE NUMMER / OE	PRAVÁ / RIGHT / RECHTS / ПРАВАЯ	LEVÁ / LEFT / LINKS / ЛЕВАЯ	OSVĚTLENÍ SPZ / ILLUMINATION FOR NUMBERPLATE / KENNZEICHENLEUCHE / ПОДСВЕТКА НОМЕРНОГО ЗНАКА	PŘIPOJENÍ / CONNECTION / ANSCHLUSS / СОЕДИНЕНИЕ	
720595	02.430.000.01	■	■			
720592 KRYT / LENS / LICHTSCHEIBE / КРЫШКА	02.356.200.01	■	■			
				722937	12V	P21 5W 12V, BAY15d
				722931	12V	P21W 12V, BA15s
				722938	24V	P21 5W 24V, BAY15d
				722932	24V	P21W 24V, BA15s

ZADNÍ SKUPINOVÉ SVÍTILNY / REAR LAMPS / HECKLEUCHTEN / ЗАДНИЕ ФОНАРИ

**2 KOMOROVÉ KONCOVÉ - BRZDOVÉ - SMĚROVÉ / 2-CHAMBER LIGHT TAIL - STOP - FLASHER LAMP /
2-KAMMER LEUCHTE SCHLUSS - BREMS - BLINKLEUCHTE /
2-ФУНКЦИОНАЛЬНАЯ ЗАДНЯЯ ФАРА - ЛАМПА СИГНАЛА СТОП/ТОРМАЖЕНИЯ - УКАЗАТЕЛЬ ПОВОРОТА**

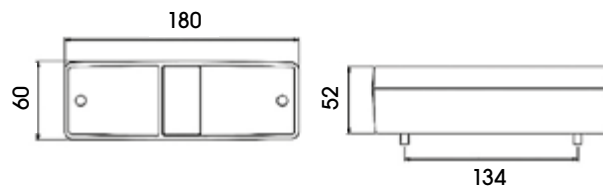

KÓD / ORDER CODE / BESTELL NR. / КОД	OE / OE NUMBER / OE NUMBER / OE	PRAVÁ / RIGHT / RECHTS / ПРАВАЯ	LEVÁ / LEFT / LINKS / ЛЕВАЯ	OSVĚTLENÍ SPZ / ILLUMINATION FOR NUMBERPLATE / KENNZEICHENLEUCHTE / ПОДСВЕТКА НОМЕРНОГО ЗНАКА	PŘIPOJENÍ / CONNECTION / ANSCHLUSS / СОЕДИНЕНИЕ	
722221		■	■			
				722937	12V	P21 5W 12V, BAY15d
				722931	12V	P21W 12V, BA15s
				722938	24V	P21 5W 24V, BAY15d
				722932	24V	P21W 24V, BA15s

**2 KOMOROVÉ KONCOVÉ - BRZDOVÉ - SMĚROVÉ / 2-CHAMBER LIGHT TAIL - STOP - FLASHER LAMP /
2-KAMMER LEUCHTE SCHLUSS - BREMS - BLINKLEUCHTE /
2-ФУНКЦИОНАЛЬНАЯ ЗАДНЯЯ ФАРА - ЛАМПА СИГНАЛА СТОП/ТОРМАЖЕНИЯ - УКАЗАТЕЛЬ ПОВОРОТА**

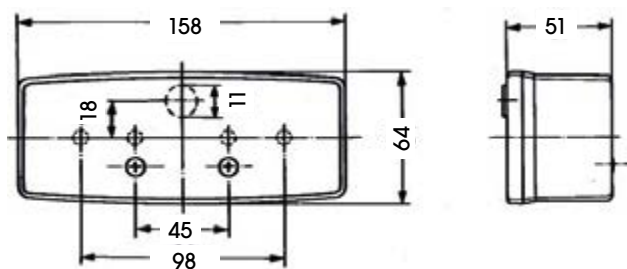

KÓD / ORDER CODE / BESTELL NR. / КОД	OE / OE NUMBER / OE NUMBER / OE	PRAVÁ / RIGHT / RECHTS / ПРАВАЯ	LEVÁ / LEFT / LINKS / ЛЕВАЯ	OSVĚTLENÍ SPZ / ILLUMINATION FOR NUMBERPLATE / KENNZEICHENLEUCHTE / ПОДСВЕТКА НОМЕРНОГО ЗНАКА	PŘIPOJENÍ / CONNECTION / ANSCHLUSS / СОЕДИНЕНИЕ	
722109	2SD003184-041	■				
722139	2SD003184-031		■			
722134	2SE003184-011	■		■		
722140 KRYT / LENS / LICHTSCHEIBE / КРЫШКА	9EL118701-001	■				
722149 KRYT / LENS / LICHTSCHEIBE / КРЫШКА	9EL118700-001		■			
				722951	24V	C5W 24V, SV8,5-8
				722944	24V	R10W 24V, BA15s
				722932	24V	P21W 24V, BA15s

ZADNÍ SKUPINOVÉ SVÍTLILNY / REAR LAMPS / HECKLEUCHTEN / ЗАДНИЕ ФОНАРИ

**2 KOMOROVÉ KONCOVÉ - BRZDOVÉ - SMĚROVÉ, PLASTOVÉ POUZDRO / 2-CHAMBER LIGHT TAIL - STOP - FLASHER LAMP, PLASTIC HOUSING /
2-KAMMER LEUCHTE SCHLUSS - BREMS - BLINKLEUCHTE, KUNSTSTOFFGEHÄUSE /
2-ФУНКЦИОНАЛЬНАЯ ЗАДНЯЯ ФАРА-ЛАМПА СИГНАЛА СТОП, ТОРМАЖЕНИЯ-УКАЗАТЕЛЬ ПОВОРОТА, ПЛАСТИКОВЫЙ КОРПУС**

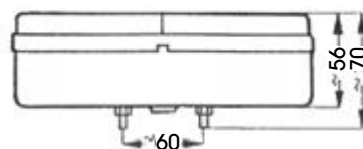

KÓD / ORDER CODE / BESTELL NR. / КОД	OE / OE NUMBER / OE NUMMER / OE	PRAVÁ / RIGHT / RECHTS / ПРАВАЯ	LEVÁ / LEFT / LINKS / ЛЕВАЯ	OSVĚTLENÍ SPZ / ILLUMINATION FOR NUMBERPLATE / KENNZEICHENLEUCHTE / ПОДСВЕТКА НОМЕРНОГО ЗНАКА	PŘIPOJENÍ / CONNECTION / ANSCHLUSS / СОЕДИНЕНИЕ	
726872	6711-5711 443312251104	■				
726873	6711-5712 443312252104		■			
726870 - KRYT / LENS / LICHTSCHEIBE / КРЫШКА	443312251104	■				
726871 - KRYT / LENS / LICHTSCHEIBE / КРЫШКА	443312252104		■			
				722937	12V	P21 5W 12V, BAY15d
				722934	12V	PY21W 12V, BAU15s
				722938	24V	P21 5W 24V, BAY15d
				722935	24V	P21W 24V, BAU15s

**2 KOMOROVÉ KONCOVÉ - BRZDOVÉ - SMĚROVÉ, PLECHOVÉ POUZDRO / 2-CHAMBER LIGHT TAIL - STOP - FLASHER LAMP, METAL HOUSING /
2-KAMMER LEUCHTE SCHLUSS - BREMS - BLINKLEUCHTE, METALLGEHÄUSE /
2-ФУНКЦИОНАЛЬНАЯ ЗАДНЯЯ ФАРА-ЛАМПА СИГНАЛА СТОП, ТОРМАЖЕНИЯ-УКАЗАТЕЛЬ ПОВОРОТА, МЕТАЛЛИЧЕСКИЙ КОРПУС**

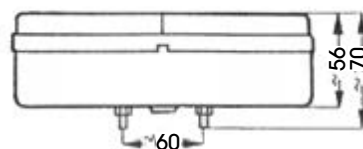
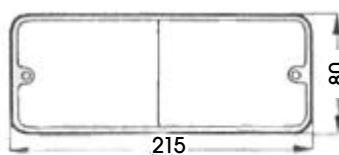

KÓD / ORDER CODE / BESTELL NR. / КОД	OE / OE NUMBER / OE NUMMER / OE	PRAVÁ / RIGHT / RECHTS / ПРАВАЯ	LEVÁ / LEFT / LINKS / ЛЕВАЯ	OSVĚTLENÍ SPZ / ILLUMINATION FOR NUMBERPLATE / KENNZEICHENLEUCHTE / ПОДСВЕТКА НОМЕРНОГО ЗНАКА	PŘIPOJENÍ / CONNECTION / ANSCHLUSS / СОЕДИНЕНИЕ	
726895	443312251104	■				
726896	443312252104		■			
726870 - KRYT / LENS / LICHTSCHEIBE / КРЫШКА	443312251104	■				
726871 - KRYT / LENS / LICHTSCHEIBE / КРЫШКА	443312252104		■			
				722937	12V	P21 5W 12V, BAY15d
				722934	12V	PY21W 12V, BAU15s
				722938	24V	P21 5W 24V, BAY15d
				722935	24V	P21W 24V, BAU15s

ZADNÍ SKUPINOVÉ SVÍTILNY / REAR LAMPS / HECKLEUCHTEN / ЗАДНИЕ ФОНАРИ

3 KOMOROVÉ SVĚTLO - KONCOVÉ - BRZDOVÉ - SMĚROVÉ / 3-CHAMBER LIGHT - STOP - FLASHER LAMP / 3-KAMMER LEUCHTE - SCHLUSS - BREMS - BLINKLEUCHTE / 3 ФУНКЦИОНАЛЬНАЯ ЗАДНЯЯ ФАРА - ЛАМПА СИГНАЛА СТОП, ТОРМАЖЕНИЯ

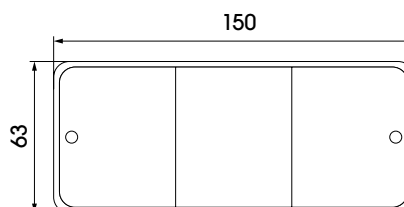

KÓD / ORDER CODE / BESTELL NR. / КОД	OE / OE NUMBER / OE NUMMER / OE	PRAVÁ / RIGHT / RECHTS / ПРАВАЯ	LEVÁ / LEFT / LINKS / ЛЕВАЯ	OSVĚTLENÍ SPZ / ILLUMINATION FOR NUMBERPLATE / KENNZEICHENLEUCHTE / ПОДСВЕТКА НОМЕРНОГО ЗНАКА	PŘIPOJENÍ / CONNECTION / ANSCHLUSS / СОЕДИНЕНИЕ	
720120		■				
720121			■	■		
720100 - KRYT / LENS / LICHTSCHEIBE / КРЫШКА		■	■			
				722931	12V	P21W 12V, BA15s
				722940	12V	R5W 12V, BA15s
				723932	24V	P21W 24V, BA15s
				722941	24V	R5W 24V, BA15s

3 KOMOROVÉ SVĚTLO - KONCOVÉ - BRZDOVÉ - SMĚROVÉ / 3-CHAMBER LIGHT - STOP - FLASHER LAMP / 3-KAMMER LEUCHTE - SCHLUSS - BREMS - BLINKLEUCHTE / 3 ФУНКЦИОНАЛЬНАЯ ЗАДНЯЯ ФАРА - ЛАМПА СИГНАЛА СТОП, ТОРМАЖЕНИЯ

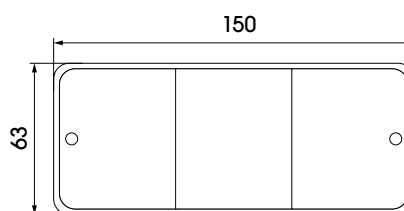

KÓD / ORDER CODE / BESTELL NR. / КОД	OE / OE NUMBER / OE NUMMER / OE	PRAVÁ / RIGHT / RECHTS / ПРАВАЯ	LEVÁ / LEFT / LINKS / ЛЕВАЯ	OSVĚTLENÍ SPZ / ILLUMINATION FOR NUMBERPLATE / KENNZEICHENLEUCHTE / ПОДСВЕТКА НОМЕРНОГО ЗНАКА	PŘIPOJENÍ / CONNECTION / ANSCHLUSS / СОЕДИНЕНИЕ	
720141		■				
720142			■	■		
720100 - KRYT / LENS / LICHTSCHEIBE / КРЫШКА		■	■			
				722931	12 V	P21W 12V, BA15s
				722940	12 V	R5W 12V, BA15s
				722943	12 V	R10W 12V, BA15s
				723932	24 V	P21W 24V, BA15s
				722941	24 V	R5W 24V, BA15s
				722944	24 V	R10W 24V, BA15s

Important notice: part of other producers are only mentioned for comparison purposes.

ZADNÍ SKUPINOVÉ SVÍTILNY / REAR LAMPS / HECKLEUCHTEN / ЗАДНИЕ ФОНАРИ

**2 KOMOROVÉ KONCOVÉ - BRZDOVÉ - SMĚROVÉ / 2-CHAMBER LIGHT TAIL - STOP - FLASHER LAMP /
2-KAMMER LEUCHE SCHLUSS - BREMS - BLINKLEUCHE /
2-ФУНКЦИОНАЛЬНАЯ ЗАДНЯЯ ФАРА-ЛАМПА СИГНАЛА СТОП/ТОРМАЖЕНИЯ-УКАЗАТЕЛЬ ПОВОРОТА**

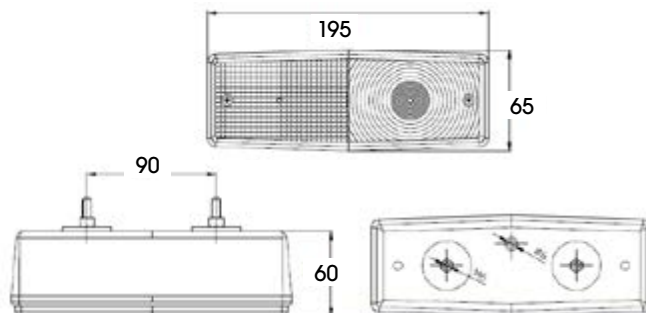

KÓD / ORDER CODE / BESTELL NR. / КОД	OE / OE NUMBER / OE NUMMER / OE	PRAVÁ / RIGHT / RECHTS / ПРАВАЯ	LEVÁ / LEFT / LINKS / ЛЕВАЯ	OSVĚTLENÍ SPZ / ILLUMINATION FOR NUMBERPLATE / KENNZEICHENLEUCHE / ПОДСВЕТКА НОМЕРНОГО ЗНАКА	PŘIPOJENÍ / CONNECTION / ANSCHLUSS / СОЕДИНЕНИЕ	
722260		■	■			
722261 KRYT / LENS / LICHTSCHEIBE / Крышка		■	■			
				722931	12V	P21W 12V, BA15s
				722937	12V	P21 5W 12V, BAY15d
				722932	24V	P21W 24V, BA15s
				722938	24V	P21 5W 24V, BAY15d

**3 KOMOROVÉ KONCOVÉ - BRZDOVÉ - SMĚROVÉ / 3-CHAMBER LIGHT TAIL - STOP - FLASHER LAMP /
3-KAMMER LEUCHE SCHLUSS - BREMS - BLINKLEUCHE /
3-ФУНКЦИОНАЛЬНАЯ ЗАДНЯЯ ФАРА-ЛАМПА СИГНАЛА СТОП, ТОРМАЖЕНИЯ-УКАЗАТЕЛЬ ПОВОРОТА**

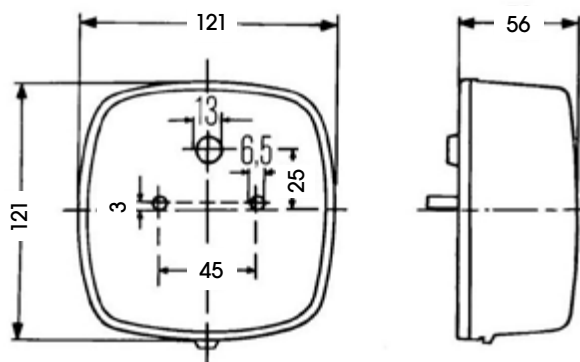

KÓD / ORDER CODE / BESTELL NR. / КОД	OE / OE NUMBER / OE NUMMER / OE	PRAVÁ / RIGHT / RECHTS / ПРАВАЯ	LEVÁ / LEFT / LINKS / ЛЕВАЯ	OSVĚTLENÍ SPZ / ILLUMINATION FOR NUMBERPLATE / KENNZEICHENLEUCHE / ПОДСВЕТКА НОМЕРНОГО ЗНАКА	PŘIPOJENÍ / CONNECTION / ANSCHLUSS / СОЕДИНЕНИЕ	
722226	2SE002578-701	■	■	■		
722227 KRYT / LENS / LICHTSCHEIBE / Крышка	9EL146491-001	■	■			
				722931	12V	P21W 12V, BA15s
				722943	12V	R10W 12V, BA15s
				722932	24V	P21W 24V, BA15s
				722944	24V	R10W 24V, BA15s

ZADNÍ SKUPINOVÉ SVÍTILNY / REAR LAMPS / HECKLEUCHTEN / ЗАДНИЕ ФОНАРИ

2 KOMOROVÉ KONCOVÉ - BRZDOVÉ - SMĚROVÉ / 2-CHAMBER LIGHT TAIL - STOP - FLASHER LAMP /
2-KAMMER LEUCHTE SCHLUSS - BREMS - BLINKLEUCHTE /
2-ФУНКЦИОНАЛЬНАЯ ЗАДНЯЯ ФАРА - ЛАМПА СИГНАЛА СТОП/ТОРМАЖЕНИЯ - УКАЗАТЕЛЬ ПОВОРОТА



IP 55

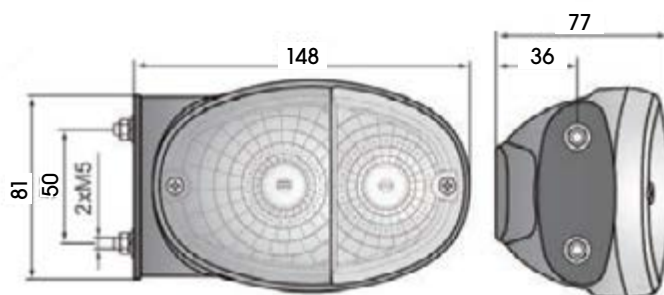

KÓD / ORDER CODE / BESTELL NR. / КОД	OE / OE NUMBER / OE NUMMER / OE	PRAVÁ / RIGHT / RECHTS / ПРАВАЯ	LEVÁ / LEFT / LINKS / ЛЕВАЯ	OSVĚTLENÍ SPZ / ILLUMINATION FOR NUMBERPLATE / KENNZEICHENLEUCHTE / ПОДСВЕТКА НОМЕРНОГО ЗНАКА	PŘIPOJENÍ / CONNECTION / ANSCHLUSS / СОЕДИНЕНИЕ
724611		■	■		
				722931	12V P21W 12V, BA15s
				722937	12V P21 5W 12V, BAY15d
				722932	24V P21W 24V, BA15s
				722938	24V P21 5W 24V, BAY15d

2 KOMOROVÉ KONCOVÉ - BRZDOVÉ - SMĚROVÉ / 2-CHAMBER LIGHT TAIL - STOP - FLASHER LAMP /
2-KAMMER LEUCHTE SCHLUSS - BREMS - BLINKLEUCHTE /
2-ФУНКЦИОНАЛЬНАЯ ЗАДНЯЯ ФАРА - ЛАМПА СИГНАЛА СТОП/ТОРМАЖЕНИЯ - УКАЗАТЕЛЬ ПОВОРОТА



COBO group

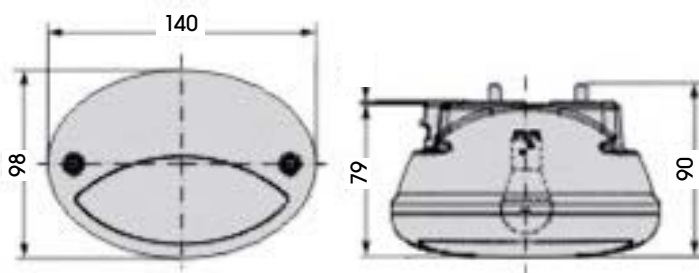

KÓD / ORDER CODE / BESTELL NR. / КОД	OE / OE NUMBER / OE NUMMER / OE	PRAVÁ / RIGHT / RECHTS / ПРАВАЯ	LEVÁ / LEFT / LINKS / ЛЕВАЯ	OSVĚTLENÍ SPZ / ILLUMINATION FOR NUMBERPLATE / KENNZEICHENLEUCHTE / ПОДСВЕТКА НОМЕРНОГО ЗНАКА	PŘIPOJENÍ / CONNECTION / ANSCHLUSS / СОЕДИНЕНИЕ
724615	02.1335.0000	■	■		
724619 KRYT / LENS / LICHTSCHEIBE / Крышка	02.1335.0200	■	■		
Opravná sada / Repair Kit / Anschlusssatz / Ремонтный комплект				722931	12V P21W 12V, BA15s
721032 				722937	12V P21 5W 12V, BAY15d
				722932	24V P21W 24V, BA15s
				722938	24V P21 5W 24V, BAY15d

Important notice: part of other producers are only mentioned for comparison purposes.

ZADNÍ SKUPINOVÉ SVÍTLILNY / REAR LAMPS / HECKLEUCHTEN / ЗАДНИЕ ФОНАРИ

2 KOMOROVÉ KONCOVÉ – BRZDOVÉ – SMĚROVÉ / 2-CHAMBER LIGHT TAIL – STOP – FLASHER LAMP /
2-KAMMER LEUCHTE SCHLUSS – BREMS – BLINKLEUCHTE /
2-ФУНКЦИОНАЛЬНАЯ ЗАДНЯЯ ФАРА – ЛАМПА СИГНАЛА СТОП, ТОРМАЖЕНИЯ – УКАЗАТЕЛЬ ПОВОРОТА



IP 55

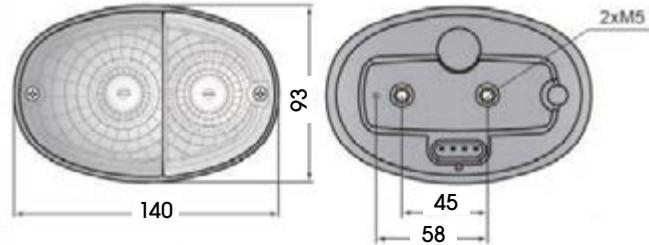



KÓD / ORDER CODE / BESTELL NR. / КОД	OE / OE NUMBER / OE NUMBER / OE	PRAVÁ / RIGHT / RECHTS / ПРАВАЯ	LEVÁ / LEFT / LINKS / ЛЕВАЯ	OSVĚTLENÍ SPZ / ILLUMINATION FOR NUMBERPLATE / KENNZEICHENLEUCHTE / ПОДСВЕТКА НОМЕРНОГО ЗНАКА	PŘIPOJENÍ / CONNECTION / ANSCHLUSS / СОЕДИНЕНИЕ
724609		■	■		
Opravná sada / Repair Kit / Anschlussatz / Ремонтный комплект				722931	12V P21W 12V, BA15s
721032 				722937	12V P21 5W 12V, BAY15d
				722932	24V P21W 24V, BA15s
				722938	24V P21 5W 24V, BAY15d

2 KOMOROVÉ KONCOVÉ – BRZDOVÉ – SMĚROVÉ / 2-CHAMBER LIGHT TAIL – STOP – FLASHER LAMP /
2-KAMMER LEUCHTE SCHLUSS – BREMS – BLINKLEUCHTE /
2-ФУНКЦИОНАЛЬНАЯ ЗАДНЯЯ ФАРА – ЛАМПА СИГНАЛА СТОП, ТОРМАЖЕНИЯ – УКАЗАТЕЛЬ ПОВОРОТА

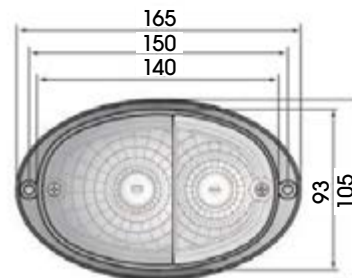

IP 55





KÓD / ORDER CODE / BESTELL NR. / КОД	OE / OE NUMBER / OE NUMBER / OE	PRAVÁ / RIGHT / RECHTS / ПРАВАЯ	LEVÁ / LEFT / LINKS / ЛЕВАЯ	OSVĚTLENÍ SPZ / ILLUMINATION FOR NUMBERPLATE / KENNZEICHENLEUCHTE / ПОДСВЕТКА НОМЕРНОГО ЗНАКА	PŘIPOJENÍ / CONNECTION / ANSCHLUSS / СОЕДИНЕНИЕ
724610		■	■		
Opravná sada / Repair Kit / Anschlussatz / Ремонтный комплект				722931	12V P21W 12V, BA15s
721032 				722937	12V P21 5W 12V, BAY15d
				722932	24V P21W 24V, BA15s
				722938	24V P21 5W 24V, BAY15d
721059					

ZADNÍ SKUPINOVÉ SVÍTLILNY / REAR LAMPS / HECKLEUCHTEN / ЗАДНИЕ ФОНАРИ

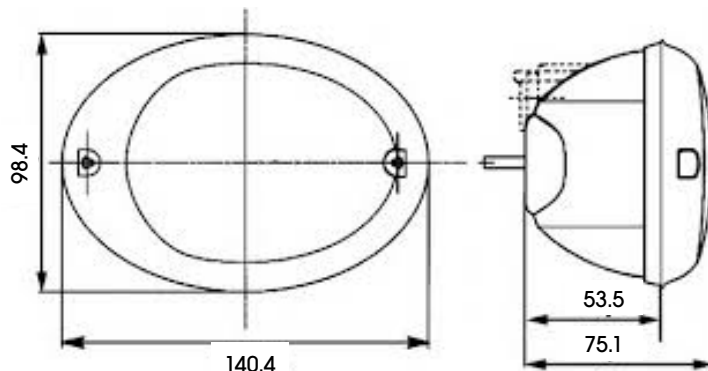

**2 KOMOROVÉ KONCOVÉ - BRZDOVÉ - SMĚROVÉ / 2-CHAMBER LIGHT TAIL - STOP - FLASHER LAMP /
2-KAMMER LEUCHE SCHLUSS - BREMS - BLINKLEUCHE /
2-ФУНКЦИОНАЛЬНАЯ ЗАДНЯЯ ФАРА-ЛАМПА СИГНАЛА СТОП, ТОРМАЖЕНИЯ-УКАЗАТЕЛЬ ПОВОРОТА**



KÓD / ORDER CODE / BESTELL NR. / КОД	OE / OE NUMBER / OE NUMMER / OE	PRAVÁ / RIGHT / RECHTS / ПРАВАЯ	LEVÁ / LEFT / LINKS / ЛЕВАЯ	OSVĚTLENÍ SPZ / ILLUMINATION FOR NUMBERPLATE / KENNZEICHENLEUCHE / ПОДСВЕТКА НОМЕРНОГО ЗНАКА	PŘIPOJENÍ / CONNECTION / ANSCHLUSS / СОЕДИНЕНИЕ	
722229	2SD343130-011	■	■	■		
Průchodka / Grommet / Gummitülle / кренгельс				722931	12V	P21W 12V, BA15s
724360				722937	12V	P21 5W 12V, BAY15d
				722932	24V	P21W 24V, BA15s
				722938	24V	P21 5W 24V, BAY15d



**2 KOMOROVÉ KONCOVÉ - BRZDOVÉ - SMĚROVÉ / 2-CHAMBER LIGHT TAIL - STOP - FLASHER LAMP /
2-KAMMER LEUCHE SCHLUSS - BREMS - BLINKLEUCHE /
2-ФУНКЦИОНАЛЬНАЯ ЗАДНЯЯ ФАРА-ЛАМПА СИГНАЛА СТОП, ТОРМАЖЕНИЯ-УКАЗАТЕЛЬ ПОВОРОТА**

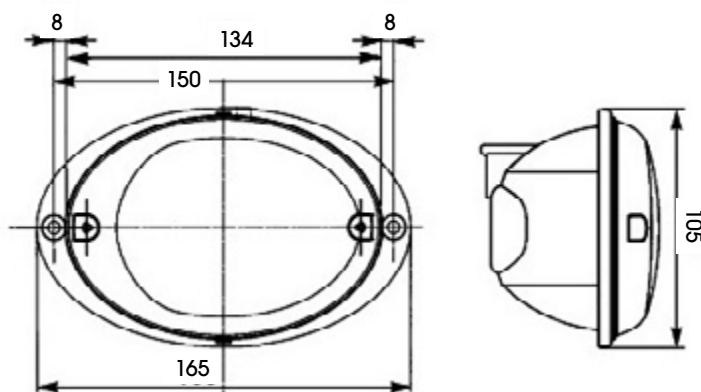

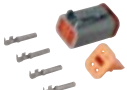
KÓD / ORDER CODE / BESTELL NR. / КОД	OE / OE NUMBER / OE NUMMER / OE	PRAVÁ / RIGHT / RECHTS / ПРАВАЯ	LEVÁ / LEFT / LINKS / ЛЕВАЯ	OSVĚTLENÍ SPZ / ILLUMINATION FOR NUMBERPLATE / KENNZEICHENLEUCHE / ПОДСВЕТКА НОМЕРНОГО ЗНАКА	PŘIPOJENÍ / CONNECTION / ANSCHLUSS / СОЕДИНЕНИЕ	
726804	2SD343130-377	■	■			
Opravná sada / Repair Kit / Anschlusssatz / Ремонтный комплект				722931	12V	P21W 12V, BA15s
721059				722937	12V	P21 5W 12V, BAY15d
				722932	24V	P21W 24V, BA15s
				722938	24V	P21 5W 24V, BAY15d

Important notice: part of other producers are only mentioned for comparison purposes.

ZADNÍ SKUPINOVÉ SVÍTLILNY / REAR LAMPS / HECKLEUCHTEN / ЗАДНИЕ ФОНАРИ



**2 KOMOROVÉ KONCOVÉ - BRZDOVÉ - SMĚROVÉ / 2-CHAMBER LIGHT TAIL - STOP - FLASHER LAMP /
2-KAMMER LEUCHTE SCHLUSS - BREMS - BLINKLEUCHTE /
2-ФУНКЦИОНАЛЬНАЯ ЗАДНЯЯ ФАРА-ЛАМПА СИГНАЛА СТОП, ТОРМОЖЕНИЯ-УКАЗАТЕЛЬ ПОВОРОТА**

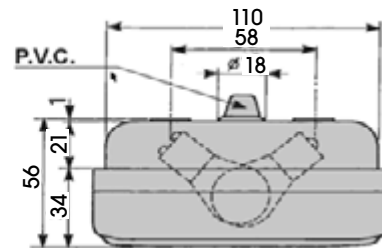
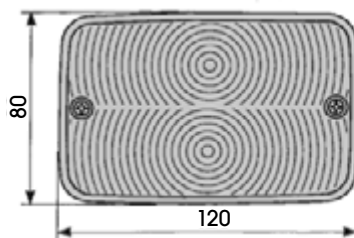

KÓD / ORDER CODE / BESTELL NR. / КОД	OE / OE NUMBER / OE NUMMER / OE	PRAVÁ / RIGHT / RECHTS / ПРАВАЯ	LEVÁ / LEFT / LINKS / ЛЕВАЯ	OSVĚTLENÍ SPZ / ILLUMINATION FOR NUMBERPLATE / KENNZEICHENLEUCHTE / ПОДСВЕТКА НОМЕРНОГО ЗНАКА	PŘIPOJENÍ / CONNECTION / ANSCHLUSS / СОЕДИНЕНИЕ	
723063	02.394.000 93-5576	■	■			
723062 KRYT / LENS / LICHTSCHEIBE / Крышка	02.394.020	■	■			
				722934	12 V	PY21W 12V, BAU15s
				722937	12 V	P21 5W 12V, BAY15d
				722935	24 V	P21W 24V, BAU15s
				722938	24 V	P21 5W 24V, BAY15d

**2 KOMOROVÉ KONCOVÉ - BRZDOVÉ - SMĚROVÉ / 2-CHAMBER LIGHT TAIL - STOP - FLASHER LAMP /
2-KAMMER LEUCHTE SCHLUSS - BREMS - BLINKLEUCHTE /
2-ФУНКЦИОНАЛЬНАЯ ЗАДНЯЯ ФАРА-ЛАМПА СИГНАЛА СТОП, ТОРМОЖЕНИЯ-УКАЗАТЕЛЬ ПОВОРОТА**

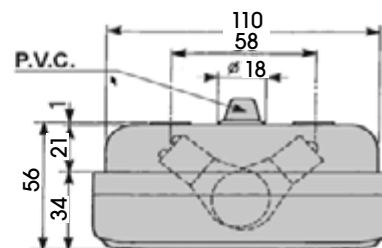
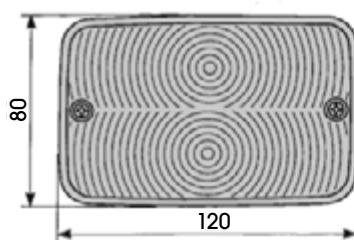

KÓD / ORDER CODE / BESTELL NR. / КОД	OE / OE NUMBER / OE NUMMER / OE	PRAVÁ / RIGHT / RECHTS / ПРАВАЯ	LEVÁ / LEFT / LINKS / ЛЕВАЯ	OSVĚTLENÍ SPZ / ILLUMINATION FOR NUMBERPLATE / KENNZEICHENLEUCHTE / ПОДСВЕТКА НОМЕРНОГО ЗНАКА	PŘIPOJENÍ / CONNECTION / ANSCHLUSS / СОЕДИНЕНИЕ	
723063/N	02.394.000 93-5576	■	■			
723062/N KRYT / LENS / LICHTSCHEIBE / Крышка	02.394.020	■	■			
				722934	12 V	PY21W 12V, BAU15s
				722937	12 V	P21 5W 12V, BAY15d
				722935	24 V	P21W 24V, BAU15s
				722938	24 V	P21 5W 24V, BAY15d

ZADNÍ SKUPINOVÉ SVÍTILNY / REAR LAMPS / HECKLEUCHTEN / ЗАДНИЕ ФОНАРИ



**3 KOMOROVÉ KONCOVÉ - BRZDOVÉ - SMĚROVÉ / 3-CHAMBER LIGHT TAIL - STOP - FLASHER LAMP /
3-KAMMER LEUCHTE SCHLUSS - BREMS - BLINKLEUCHTE /
3-ФУНКЦИОНАЛЬНАЯ ЗАДНЯЯ ФАРА-ЛАМПА СИГНАЛА СТОП, ТОРМАЖЕНИЯ-УКАЗАТЕЛЬ ПОВОРОТА**

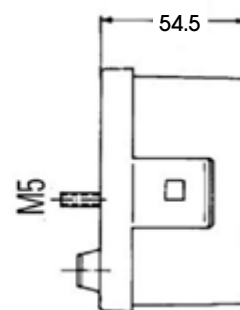
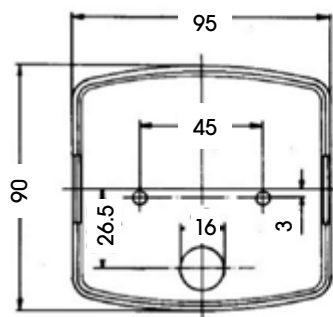

KÓD / ORDER CODE / BESTELL NR. / КОД	OE / OE NUMBER / OE NUMMER / OE	PRAVÁ / RIGHT / RECHTS / ПРАВАЯ	LEVÁ / LEFT / LINKS / ЛЕВАЯ	OSVĚTLENÍ SPZ / ILLUMINATION FOR NUMBERPLATE / KENNZEICHENLEUCHTE / ПОДСВЕТКА НОМЕРНОГО ЗНАКА	PŘIPOJENÍ / CONNECTION / ANSCHLUSS / СОЕДИНЕНИЕ	
722297	2SD002776-241	■				
722298	2SD002776-031		■			
722299 - KRYT / LENS / LICHTSCHEIBE / КРЫШКА	9EL137308-001	■				
722300 - KRYT / LENS / LICHTSCHEIBE / КРЫШКА	9EL137307-001		■			
				722931	12V	P21W 12V, BA15s
				722943	12V	R10W 12V, BA15s
				722932	24V	P21W 24V, BA15s
				722944	24V	R10W 24V, BA15s



**2 KOMOROVÉ KONCOVÉ - SMĚROVÉ / 2-CHAMBER LIGHT TAIL - STOP - FLASHER LAMP /
2-KAMMER LEUCHTE SCHLUSS - BREMS - BLINKLEUCHTE /
2-ФУНКЦИОНАЛЬНАЯ ЗАДНЯЯ ФАРА-ЛАМПА СИГНАЛА СТОП, ТОРМАЖЕНИЯ-УКАЗАТЕЛЬ ПОВОРОТА**

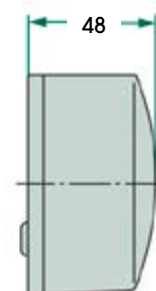
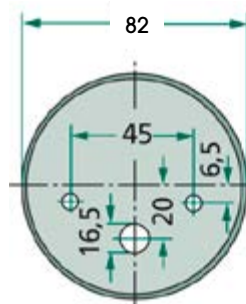

KÓD / ORDER CODE / BESTELL NR. / КОД	OE / OE NUMBER / OE NUMMER / OE	PRAVÁ / RIGHT / RECHTS / ПРАВАЯ	LEVÁ / LEFT / LINKS / ЛЕВАЯ	OSVĚTLENÍ SPZ / ILLUMINATION FOR NUMBERPLATE / KENNZEICHENLEUCHTE / ПОДСВЕТКА НОМЕРНОГО ЗНАКА	PŘIPOJENÍ / CONNECTION / ANSCHLUSS / СОЕДИНЕНИЕ	
722772	2SW003185-041	■	■	■		
722773 KRYT / LENS / LICHTSCHEIBE / Крышка	9EL118633-001	■	■			
				722931	12V	P21W 12V, BA15s
				722950	12V	C5W 12V, SV8,5-8
				722932	24V	P21W 24V, BA15s
				722951	24V	C5W 24V, SV8,5-8

ZADNÍ SKUPINOVÉ SVÍTLILNY / REAR LAMPS / HECKLEUCHTEN / ЗАДНИЕ ФОНАРИ

**3 KOMOROVÉ KONCOVÉ - BRZDOVÉ - SMĚROVÉ / 3-CHAMBER LIGHT TAIL - STOP - FLASHER LAMP /
3-KAMMER LEUCHTE SCHLUSS - BREMS - BLINKLEUCHTE /
3-ФУНКЦИОНАЛЬНАЯ ЗАДНЯЯ ФАРА-ЛАМПА СИГНАЛА СТОП, ТОРМОЖЕНИЯ-УКАЗАТЕЛЬ ПОВОРОТА**

IP 54

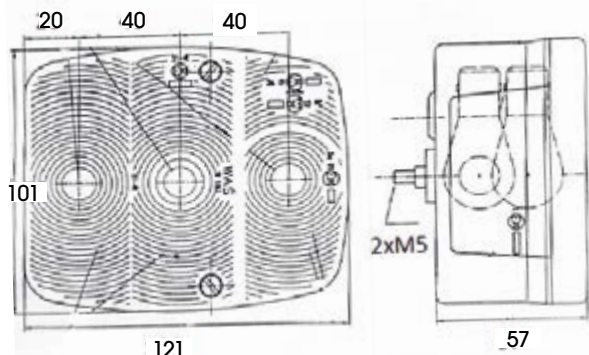

KÓD / ORDER CODE / BESTELL NR. / КОД	OE / OE NUMBER / OE NUMBER / OE	PRAVÁ / RIGHTS / RECHTS / ПРАВАЯ	LEVÁ / LEFT / LINKS / ЛЕВАЯ	OSVĚTLENÍ SPZ / ILLUMINATION FOR NUMBERPLATE / KENNZEICHENLEUCHTE / ПОДСВЕТКА НОМЕРНОГО ЗНАКА	PŘIPOJENÍ / CONNECTION / ANSCHLUSS / СОЕДИНЕНИЕ
720241		■	■	■	
				722940	12V R5W 12V, BA15s
				722931	12V P21W 12V, BA15s
				722941	24V R5W 24V, BA15s
				722932	24V P21W 24V, BA15s

**3 KOMOROVÉ KONCOVÉ - BRZDOVÉ - SMĚROVÉ / 3-CHAMBER LIGHT TAIL - STOP - FLASHER LAMP /
3-KAMMER LEUCHTE SCHLUSS - BREMS - BLINKLEUCHTE /
3-ФУНКЦИОНАЛЬНАЯ ЗАДНЯЯ ФАРА-ЛАМПА СИГНАЛА СТОП, ТОРМОЖЕНИЯ-УКАЗАТЕЛЬ ПОВОРОТА**

ECE

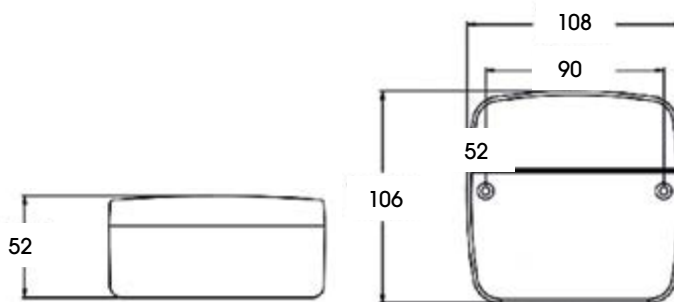

KÓD / ORDER CODE / BESTELL NR. / КОД	OE / OE NUMBER / OE NUMBER / OE	PRAVÁ / RIGHTS / RECHTS / ПРАВАЯ	LEVÁ / LEFT / LINKS / ЛЕВАЯ	OSVĚTLENÍ SPZ / ILLUMINATION FOR NUMBERPLATE / KENNZEICHENLEUCHTE / ПОДСВЕТКА НОМЕРНОГО ЗНАКА	PŘIPOJENÍ / CONNECTION / ANSCHLUSS / СОЕДИНЕНИЕ
720017		■	■	■	
729310 KRYT / LENS / LICHTSCHEIBE / КРЫШКА		■	■		
				722940	12V R5W 12V, BA15s
				722931	12V P21W 12V, BA15s
				722941	24V R5W 24V, BA15s
				722932	24V P21W 24V, BA15s

ZADNÍ SKUPINOVÉ SVÍTILNY / REAR LAMPS / HECKLEUCHTEN / ЗАДНИЕ ФОНАРИ

**3 KOMOROVÉ KONCOVÉ - BRZDOVÉ - SMĚROVÉ / 3-CHAMBER LIGHT TAIL - STOP - FLASHER LAMP /
3-KAMMER LEUCHE SCHLUSS - BREMS - BLINKLEUCHE /
3-ФУНКЦИОНАЛЬНАЯ ЗАДНЯЯ ФАРА-ЛАМПА СИГНАЛА СТОП, ТОРМАЖЕНИЯ-УКАЗАТЕЛЬ ПОВОРОТА**

IP 55

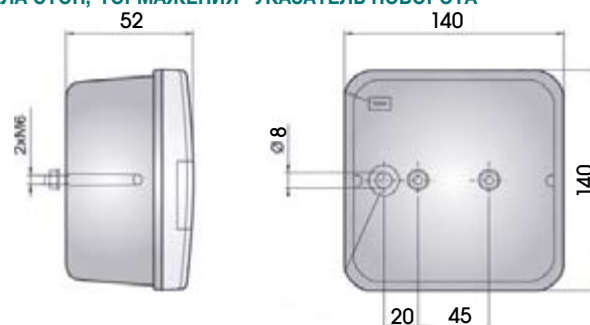

KÓD / ORDER CODE / BESTELL NR. / КОД	OE / OE NUMBER / OE NUMMER / OE	PRAVÁ / RIGHT / RECHTS / ПРАВАЯ	LEVÁ / LEFT / LINKS / ЛЕВАЯ	OSVĚTLENÍ SPZ / ILLUMINATION FOR NUMBERPLATE / KENNZEICHENLEUCHE / ПОДСВЕТКА НОМЕРНОГО ЗНАКА	PŘIPOJENÍ / CONNECTION / ANSCHLUSS / СОЕДИНЕНИЕ
720258	53-351.901	■	■		
720218 KRYT / LENS / LICHTSCHEIBE / КРЫШКА	93-3254	■	■		
				722943	12V R10W 12V, BA15s
				722931	12V P21W 12V, BA15s
				722944	24V R10W 24V, BA15s
				722932	24V P21W 24V, BA15s

**3 KOMOROVÉ KONCOVÉ - BRZDOVÉ - SMĚROVÉ / 3-CHAMBER LIGHT TAIL - STOP - FLASHER LAMP /
3-KAMMER LEUCHE SCHLUSS - BREMS - BLINKLEUCHE /
3-ФУНКЦИОНАЛЬНАЯ ЗАДНЯЯ ФАРА-ЛАМПА СИГНАЛА СТОП, ТОРМАЖЕНИЯ-УКАЗАТЕЛЬ ПОВОРОТА**

IP 55

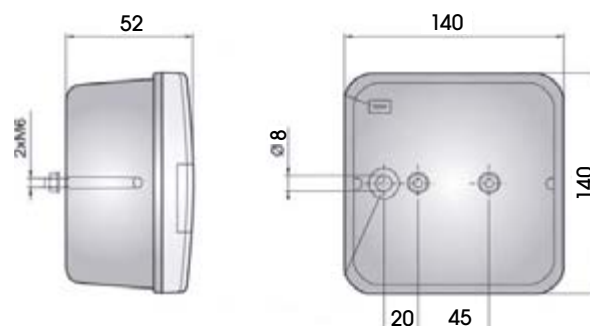

KÓD / ORDER CODE / BESTELL NR. / КОД	OE / OE NUMBER / OE NUMMER / OE	PRAVÁ / RIGHT / RECHTS / ПРАВАЯ	LEVÁ / LEFT / LINKS / ЛЕВАЯ	OSVĚTLENÍ SPZ / ILLUMINATION FOR NUMBERPLATE / KENNZEICHENLEUCHE / ПОДСВЕТКА НОМЕРНОГО ЗНАКА	PŘIPOJENÍ / CONNECTION / ANSCHLUSS / СОЕДИНЕНИЕ
720259		■	■	■	
720218 KRYT / LENS / LICHTSCHEIBE / КРЫШКА	93-3254	■	■		
				722943	12V R10W 12V, BA15s
				722931	12V P21W 12V, BA15s
				722944	24V R10W 24V, BA15s
				722932	24V P21W 24V, BA15s

Important notice: part of other producers are only mentioned for comparison purposes.

ZADNÍ SKUPINOVÉ SVÍTLILNY / REAR LAMPS / HECKLEUCHTEN / ЗАДНИЕ ФОНАРИ

**2 KOMOROVÉ KONCOVÉ – BRZDOVÉ – SMĚROVÉ / 2-CHAMBER LIGHT TAIL – STOP – FLASHER LAMP /
2-KAMMER LEUCHTE SCHLUSS – BREMS – BLINKLEUCHTE /
2-ФУНКЦИОНАЛЬНАЯ ЗАДНЯЯ ФАРА – ЛАМПА СИГНАЛА СТОП, ТОРМАЖЕНИЯ – УКАЗАТЕЛЬ ПОВОРОТА**

IP 54

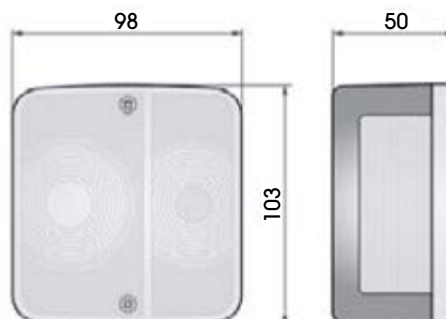

KÓD / ORDER CODE / BESTELL NR. / КОД	OE / OE NUMBER / OE NUMMER / OE	PRAVÁ / RIGHT / RECHTS / ПРАВАЯ	LEVÁ / LEFT / LINKS / ЛЕВАЯ	OSVĚTLENÍ SPZ / ILLUMINATION FOR NUMBERPLATE / KENNZEICHENLEUCHTE / ПОДСВЕТКА НОМЕРНОГО ЗНАКА	PŘIPOJENÍ / CONNECTION / ANSCHLUSS / СОЕДИНЕНИЕ	
720242		■	■			
722404 KRYT / LENS / LICHTSCHEIBE / КРЫШКА		■	■			
				722937	12V	P21 5W 12V, BAY15d
				722931	12V	P21W 12V, BA15s
				722938	24V	P21 5W 24V, BAY15d
				722932	24V	P21W 24V, BA15s

**2 KOMOROVÉ KONCOVÉ – BRZDOVÉ – SMĚROVÉ / 2-CHAMBER LIGHT TAIL – STOP – FLASHER LAMP /
2-KAMMER LEUCHTE SCHLUSS – BREMS – BLINKLEUCHTE /
2-ФУНКЦИОНАЛЬНАЯ ЗАДНЯЯ ФАРА – ЛАМПА СИГНАЛА СТОП, ТОРМАЖЕНИЯ – УКАЗАТЕЛЬ ПОВОРОТА**

IP 56

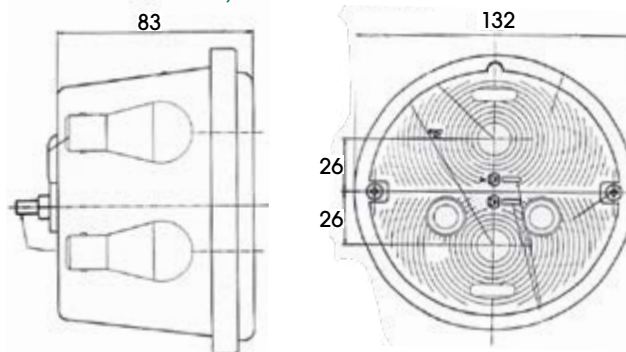



KÓD / ORDER CODE / BESTELL NR. / КОД	OE / OE NUMBER / OE NUMMER / OE	PRAVÁ / RIGHT / RECHTS / ПРАВАЯ	LEVÁ / LEFT / LINKS / ЛЕВАЯ	OSVĚTLENÍ SPZ / ILLUMINATION FOR NUMBERPLATE / KENNZEICHENLEUCHTE / ПОДСВЕТКА НОМЕРНОГО ЗНАКА	PŘIPOJENÍ / CONNECTION / ANSCHLUSS / СОЕДИНЕНИЕ	
723064		■				
723065			■	■		
723066 KRYT / LENS / LICHTSCHEIBE / КРЫШКА		■	■			
				722937	12V	P21 5W 12V, BAY15d
				722931	12V	P21W 12V, BA15s
				722938	24V	P21 5W 24V, BAY15d
				722932	24V	P21W 24V, BA15s

ZADNÍ SKUPINOVÉ SVÍTILNY / REAR LAMPS / HECKLEUCHTEN / ЗАДНИЕ ФОНАРИ

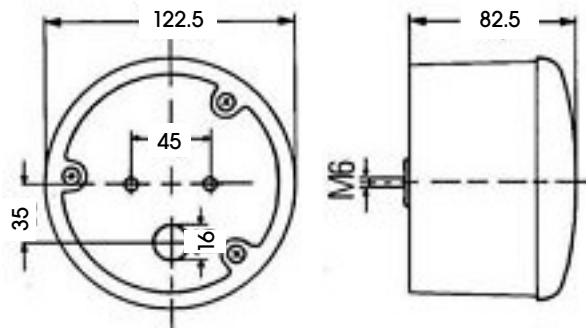

**2 KOMOROVÉ KONCOVÉ - BRZDOVÉ - SMĚROVÉ / 2-CHAMBER LIGHT TAIL - STOP - FLASHER LAMP /
2-KAMMER LEUCHE SCHLUSS - BREMS - BLINKLEUCHE /
2-ФУНКЦИОНАЛЬНАЯ ЗАДНЯЯ ФАРА-ЛАМПА СИГНАЛА СТОП, ТОРМАЖЕНИЯ-УКАЗАТЕЛЬ ПОВОРОТА**





KÓD / ORDER CODE / BESTELL NR. / КОД	OE / OE NUMBER / OE NUMBER / OE	PRAVÁ / RIGHT / RECHTS / ПРАВАЯ	LEVÁ / LEFT / LINKS / ЛЕВАЯ	OSVĚTLENÍ SPZ / ILLUMINATION FOR NUMBERPLATE / KENNZEICHENLEUCHE / ПОДСВЕТКА НОМЕРНОГО ЗНАКА	PŘIPOJENÍ / CONNECTION / ANSCHLUSS / СОЕДИНЕНИЕ	
724352	2SD964169-111	■	■			
724353 KRYT / LENS / LICHTSCHEIBE / Крышка	9EL964536-001	■	■			
Průchodka / Grommet / Gummitülle / кренгельс				722931	12V	P21W 12V, BA15s
724360				722937	12V	P21 5W 12V, BAY15d
				722932	24V	P21W 24V, BA15s
				722938	24V	P21 5W 24V, BAY15d

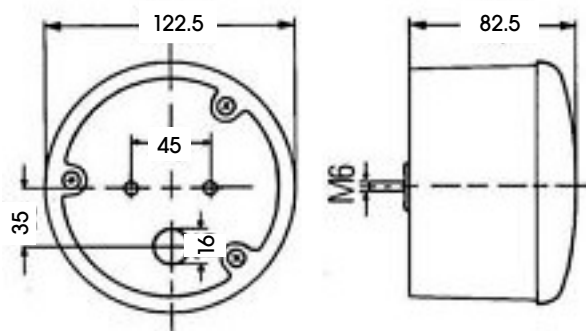

**KONCOVÉ - BRZDOVÉ / TAIL - STOP /
BREMS - BLINKLEUCHE /
ЛАМПА СИГНАЛА СТОП, УКАЗАТЕЛЬ ПОВОРОТА**



KÓD / ORDER CODE / BESTELL NR. / КОД	OE / OE NUMBER / OE NUMBER / OE	PRAVÁ / RIGHT / RECHTS / ПРАВАЯ	LEVÁ / LEFT / LINKS / ЛЕВАЯ	OSVĚTLENÍ SPZ / ILLUMINATION FOR NUMBERPLATE / KENNZEICHENLEUCHE / ПОДСВЕТКА НОМЕРНОГО ЗНАКА	PŘIPOJENÍ / CONNECTION / ANSCHLUSS / СОЕДИНЕНИЕ	
724354	2TA964169-061	■	■			
724355 KRYT / LENS / LICHTSCHEIBE / Крышка	9EL964532-001	■	■			
Průchodka / Grommet / Gummitülle / кренгельс				722937	12V	P21 5W 12V, BAY15d
724360				722938	24V	P21 5W 24V, BAY15d

Important notice: part of other producers are only mentioned for comparison purposes.

ZADNÍ SKUPINOVÉ SVÍTILNY / REAR LAMPS / HECKLEUCHTEN / ЗАДНИЕ ФОНАРИ



BRZDOVÉ / STOP / BREMS / ЛАМПА СИГНАЛА СТОП

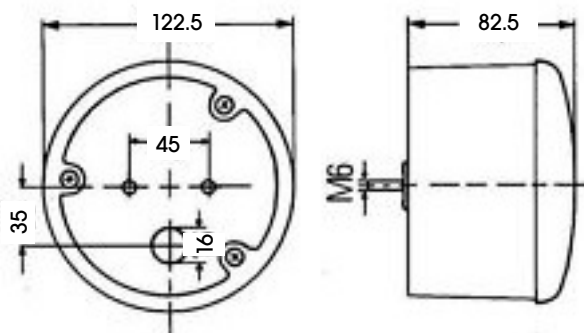

KÓD / ORDER CODE / BESTELL NR. / КОД	OE / OE NUMBER / OE NUMMER / OE	PRAVÁ / RIGHT / RECHTS / ПРАВАЯ	LEVÁ / LEFT / LINKS / ЛЕВАЯ	OSVĚTLENÍ SPZ / ILLUMINATION FOR NUMBERPLATE / KENNZEICHENLEUCHTE / ПОДСВЕТКА НОМЕРНОГО ЗНАКА	PŘIPOJENÍ / CONNECTION / ANSCHLUSS / СОЕДИНЕНИЕ	
724358	2DA964169-001	■	■			
724359 KRYT / LENS / LICHTSCHEIBE / Крышка	EL964526-001	■	■			
Průchodka / Grommet / Gummitülle / кренгельс				722931	12V	P21W 12V, BA15s
724360				722932	24V	P21W 24V, BA15s

3 KOMOROVÉ KONCOVÉ - BRZDOVÉ - SMĚROVÉ / 3-CHAMBER LIGHT TAIL - STOP - FLASHER LAMP / 3-KAMMERN LEUCHTE SCHLUSS - BREMS - BLINKLEUCHTE / 3-ФУНКЦИОНАЛЬНАЯ ЗАДНЯЯ ФАРА-ЛАМПА СИГНАЛА СТОП, ТОРМАЖЕНИЯ-УКАЗАТЕЛЬ ПОВОРОТА

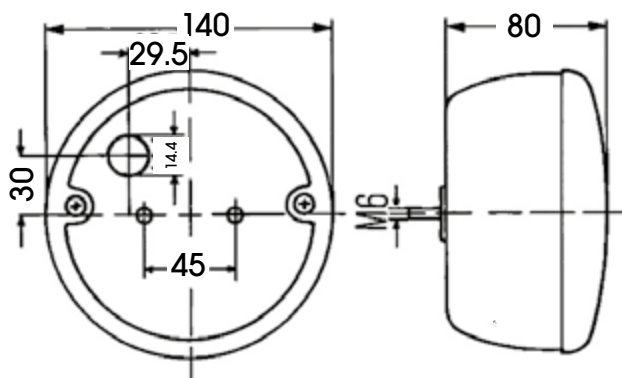

KÓD / ORDER CODE / BESTELL NR. / КОД	OE / OE NUMBER / OE NUMMER / OE	PRAVÁ / RIGHT / RECHTS / ПРАВАЯ	LEVÁ / LEFT / LINKS / ЛЕВАЯ	OSVĚTLENÍ SPZ / ILLUMINATION FOR NUMBERPLATE / KENNZEICHENLEUCHTE / ПОДСВЕТКА НОМЕРНОГО ЗНАКА	PŘIPOJENÍ / CONNECTION / ANSCHLUSS / СОЕДИНЕНИЕ	
727335	443312268103	■				
727336	443312269103		■			
727337 KRYT / LENS / LICHTSCHEIBE / КРЫШКА		■	■			
				722931	12V	P21W 12V, BA15s
				722940	12V	R5W 12V, BA15s
				722932	24V	P21W 24V, BA15s
				722941	24V	R5W 24V, BA15s

ZADNÍ SKUPINOVÉ SVÍTILNY / REAR LAMPS / HECKLEUCHTEN / ЗАДНИЕ ФОНАРИ



**2 KOMOROVÉ KONCOVÉ - BRZDOVÉ - SMĚROVÉ / 2-CHAMBER LIGHT TAIL - STOP - FLASHER LAMP /
2-KAMMER LEUCHE SCHLUSS - BREMS - BLINKLEUCHE /
2-ФУНКЦИОНАЛЬНАЯ ЗАДНЯЯ ФАРА-ЛАМПА СИГНАЛА СТОП, ТОРМАЖЕНИЯ-УКАЗАТЕЛЬ ПОВОРОТА**

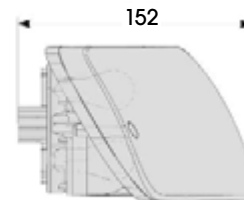
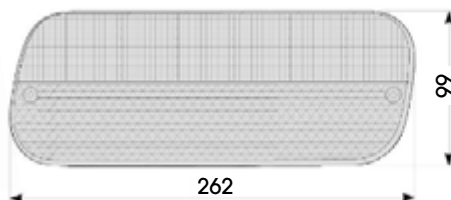

KÓD / ORDER CODE / BESTELL NR. / КОД	OE / OE NUMBER / OE NUMMER / OE	PRAVÁ / RIGHT / RECHTS / ПРАВАЯ	LEVÁ / LEFT / LINKS / ЛЕВАЯ	OSVĚTLENÍ SPZ / ILLUMINATION FOR NUMBERPLATE / KENNZEICHENLEUCHE / ПОДСВЕТКА НОМЕРНОГО ЗНАКА	PŘIPOJENÍ / CONNECTION / ANSCHLUSS / СОЕДИНЕНИЕ	
725207	02.1000.0000	■				
725202	02.0999.0000		■			
725206 KRYT / LENS / LICHTSCHEIBE / Крышка	02.1340.0200	■				
725205 KRYT / LENS / LICHTSCHEIBE / Крышка	02.1339.0200		■			
				722934	12 V	PY21W 12V, BAU15s
				722937	12 V	P21 5W 12V, BAY15d
				722935	24 V	PY21W 24V, BAU15s
				722938	24 V	P21 5W 24V, BAY15d



**2 KOMOROVÉ KONCOVÉ - BRZDOVÉ - SMĚROVÉ / 2-CHAMBER LIGHT TAIL - STOP - FLASHER LAMP /
2-KAMMER LEUCHE SCHLUSS - BREMS - BLINKLEUCHE /
2-ФУНКЦИОНАЛЬНАЯ ЗАДНЯЯ ФАРА-ЛАМПА СИГНАЛА СТОП, ТОРМАЖЕНИЯ-УКАЗАТЕЛЬ ПОВОРОТА**

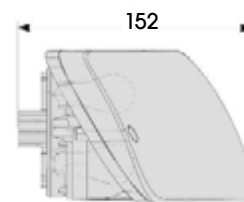
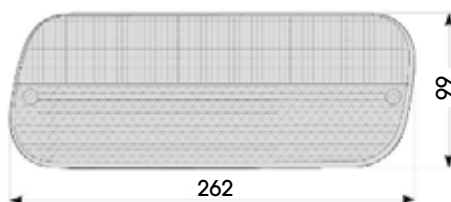

KÓD / ORDER CODE / BESTELL NR. / КОД	OE / OE NUMBER / OE NUMMER / OE	PRAVÁ / RIGHT / RECHTS / ПРАВАЯ	LEVÁ / LEFT / LINKS / ЛЕВАЯ	OSVĚTLENÍ SPZ / ILLUMINATION FOR NUMBERPLATE / KENNZEICHENLEUCHE / ПОДСВЕТКА НОМЕРНОГО ЗНАКА	PŘIPOJENÍ / CONNECTION / ANSCHLUSS / СОЕДИНЕНИЕ	
725208	02.1157.0000	■				
725203	02.1156.0000		■			
725210 KRYT / LENS / LICHTSCHEIBE / Крышка	02.1157.0200	■				
725209 KRYT / LENS / LICHTSCHEIBE / Крышка	02.1156.0200		■			
				722934	12 V	PY21W 12V, BAU15s
				722937	12 V	P21 5W 12V, BAY15d
				722935	24 V	PY21W 24V, BAU15s
				722938	24 V	P21 5W 24V, BAY15d

Important notice: part of other producers are only mentioned for comparison purposes.

ZADNÍ SKUPINOVÉ SVÍTILNY / REAR LAMPS / HECKLEUCHTEN / ЗАДНИЕ ФОНАРИ



2 KOMOROVÉ KONCOVÉ - BRZDOVÉ - SMĚROVÉ / 2-CHAMBER LIGHT TAIL - STOP - FLASHER LAMP /
2-KAMMER LEUCHTE SCHLUSS - BREMS - BLINKLEUCHTE /
2-ФУНКЦИОНАЛЬНАЯ ЗАДНЯЯ ФАРА-ЛАМПА СИГНАЛА СТОП, ТОРМАЖЕНИЯ-УКАЗАТЕЛЬ ПОВОРОТА

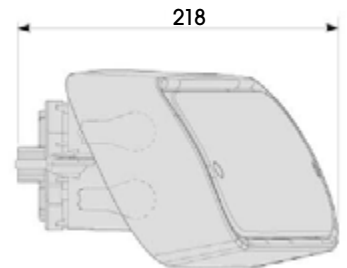
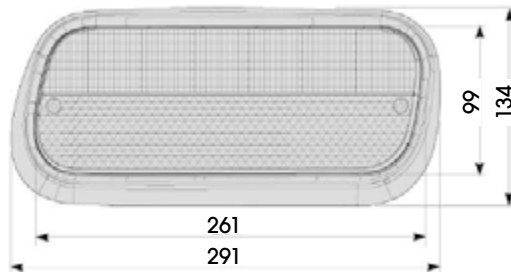

KÓD / ORDER CODE / BESTELL NR. / КОД	OE / OE NUMBER / OE NUMMER / OE	PRAVÁ / RIGHT / RECHTS / ПРАВАЯ	LEVÁ / LEFT / LINKS / ЛЕВАЯ	OSVĚTLENÍ SPZ / ILLUMINATION FOR NUMBERPLATE / KENNZEICHENLEUCHTE / ПОДСВЕТКА НОМЕРНОГО ЗНАКА	PŘIPOJENÍ / CONNECTION / ANSCHLUSS / СОЕДИНЕНИЕ	
725204	02.1340.0000	■				
725201	02.1339.0000		■			
725206 KRYT / LENS / LICHTSCHEIBE / Крышка	02.1340.0200	■				
725205 KRYT / LENS / LICHTSCHEIBE / Крышка	02.1339.0200		■			
				722934	12 V	PY21W 12V, BAU15s
				722937	12 V	P21 5W 12V, BAY15d
				722935	24 V	PY21W 24V, BAU15s
				722938	24 V	P21 5W 24V, BAY15d

ZADNÍ SKUPINOVÉ SVÍTILNY / REAR LAMPS / HECKLEUCHTEN / ЗАДНИЕ ФОНАРИ

9-33V 

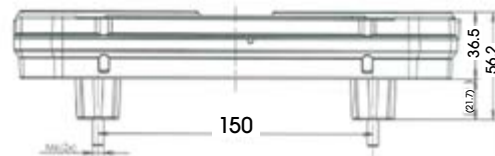
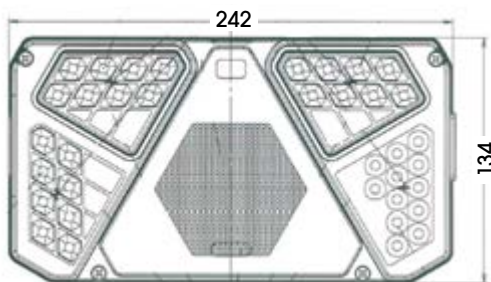

KÓD / ORDER CODE / BESTELL NR. / КОД	OE / OE NUMBER / OE NUMMER / OE	PRAVÁ / RIGHT / RECHTS / ПРАВАЯ	LEVÁ / LEFT / LINKS / ЛЕВАЯ	OSVĚTLENÍ SPZ / ILLUMINATION FOR NUMBERPLATE / KENNZEICHENLEUCHE / ПОДСВЕТКА НОМЕРНОГО ЗНАКА	PŘIPOJENÍ / CONNECTION / ANSCHLUSS / СОЕДИНЕНИЕ
724533		■			KABEL - 2 m CABLE - 2 m KABEL - 2 m Кабель - 2 м
724534			■		

LCG LED Modul / LCG LED Control-Gear /
LCG LED Kontrolle-Gang / LCG светодиодный модуль управления

721788	12 V	
721789	24 V	

Important notice: part of other producers are only mentioned for comparison purposes.

ZADNÍ SKUPINOVÉ SVÍTLILNY / REAR LAMPS / HECKLEUCHTEN / ЗАДНИЕ ФОНАРИ

SVĚTLO KONCOVÉ, BRZDOVÉ, SMĚROVÉ, COUVACÍ, MLHOVÉ / REAL LAMP, BRAKING, DIRECTIONAL, REVERSE, FOG /
LICHT ENDE, BREMSEN, RICHTUNGS, RÜCKWÄRTS, NEBEL / ЛЕГКИЙ КОНЕЦ, ТОРМОЗА, НАПРАВЛЕННЫЙ, ОБРАТНАЯ, ТУМАН

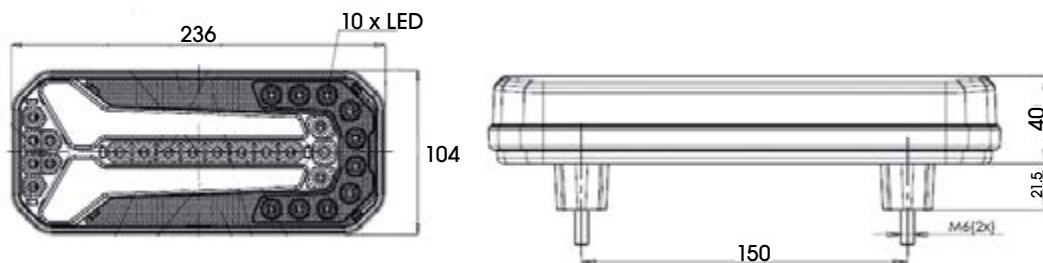

KÓD / ORDER CODE / BESTELL NR. / КОД	OE / OE NUMBER / OE NUMMER / OE	PRAVÁ / RIGHT / RECHTS / ПРАВАЯ	LEVÁ / LEFT / LINKS / ЛЕВАЯ	OSVĚTLENÍ SPZ / ILLUMINATION FOR NUMBERPLATE / KENNZEICHENLEUCHE / ПОДСВЕТКА НОМЕРНОГО ЗНАКА	PŘIPOJENÍ / CONNECTION / ANSCHLUSS / СОЕДИНЕНИЕ	
721893		■	■	■	KABEL - 2 m CABLE - 2 m KABEL - 2 m Кабель - 2 м	
LCG LED Modul / LCG LED Control-Gear / LCG LED Kontrolle-Gang / LCG светодиодный модуль управления			LCG LED Modul / LCG LED Control-Gear / LCG LED Kontrolle-Gang / LCG светодиодный модуль управления			
721788	12 V			721789	24 V	

ZADNÍ SKUPINOVÉ SVÍTILNY / REAR LAMPS / HECKLEUCHTEN / ЗАДНИЕ ФОНАРИ

SVĚTLO KONCOVÉ, BRZDOVÉ, SMĚROVÉ, COUVACÍ / REAL LAMP, BRAKING, DIRECTIONAL, REVERSE /
LICHT ENDE, BREMSEN, RICHTUNGS, RÜCKWÄRTS / ЛЕГКИЙ КОНЕЦ, ТОРМОЗА, НАПРАВЛЕННЫЙ, ОБРАТНАЯ

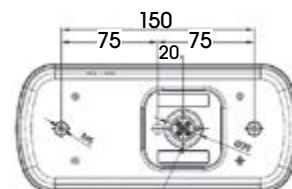
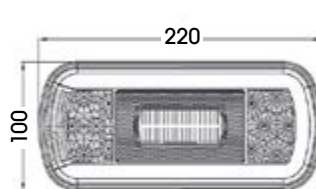

9-33V 



KÓD / ORDER CODE / BESTELL NR. / КОД	OE / OE NUMBER / OE NUMMER / OE	PRAVÁ / RIGHT / RECHTS / ПРАВАЯ	LEVÁ / LEFT / LINKS / ЛЕВАЯ	OSVĚTLENÍ SPZ / ILLUMINATION FOR NUMBERPLATE / KENNZEICHENLEUCHTE / ПОДСВЕТКА НОМЕРНОГО ЗНАКА	PŘIPOJENÍ / CONNECTION / ANSCHLUSS / СОЕДИНЕНИЕ
724590		■	■	■	

LCG LED Modul / LCG LED Control-Gear /
LCG LED Kontrolle-Gang / LCG светодиодный модуль управления

Opravná sada / Repair Kit / Anschlusssatz /
Ремонтный комплект

721788	12 V		721761 PRAVÁ / RIGHT / RECHTS / Правая	13-0523-044	
721789	24 V		721760 LEVÁ / LEFT / LINKS / Левая	13-0521-044	

SVĚTLO KONCOVÉ, BRZDOVÉ, SMĚROVÉ, MLHOVÉ / REAL LAMP, BRAKING, DIRECTIONAL, FOG /
LICHT ENDE, BREMSEN, RICHTUNGS-, NEBEL / ЛЕГКИЙ КОНЕЦ, ТОРМОЗА, НАПРАВЛЕННЫЙ, ТУМАН

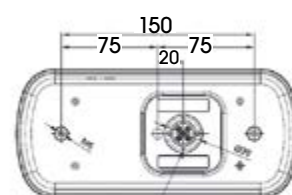
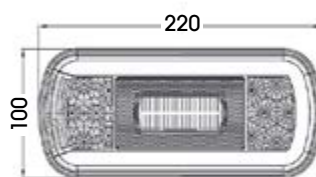

9-33V 



KÓD / ORDER CODE / BESTELL NR. / КОД	OE / OE NUMBER / OE NUMMER / OE	PRAVÁ / RIGHT / RECHTS / ПРАВАЯ	LEVÁ / LEFT / LINKS / ЛЕВАЯ	OSVĚTLENÍ SPZ / ILLUMINATION FOR NUMBERPLATE / KENNZEICHENLEUCHTE / ПОДСВЕТКА НОМЕРНОГО ЗНАКА	PŘIPOJENÍ / CONNECTION / ANSCHLUSS / СОЕДИНЕНИЕ
724591		■	■	■	

LCG LED Modul / LCG LED Control-Gear /
LCG LED Kontrolle-Gang / LCG светодиодный модуль управления

Opravná sada / Repair Kit / Anschlusssatz /
Ремонтный комплект

721788	12 V		721761 PRAVÁ / RIGHT / RECHTS / Правая	13-0523-044	
721789	24 V		721760 LEVÁ / LEFT / LINKS / Левая	13-0521-044	

Important notice: part of other producers are only mentioned for comparison purposes.

ZADNÍ SKUPINOVÉ SVÍTLILNY / REAR LAMPS / HECKLEUCHTEN / ЗАДНИЕ ФОНАРИ

SVĚTLO KONCOVÉ, BRZDOVÉ, SMĚROVÉ / REAL LAMP, BRAKING, DIRECTIONAL /
LICHT ENDE, BREMSEN, RICHTUNGS / ЛЕГКИЙ КОНЕЦ, ТОРМОЗА, НАПРАВЛЕННЫЙ /

9-33V

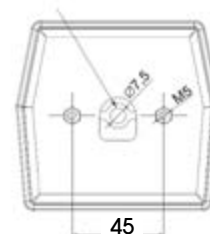
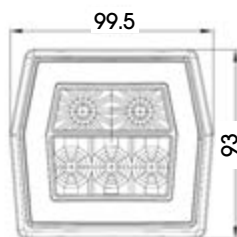

KÓD / ORDER CODE / BESTELL NR. / КОД	OE / OE NUMBER / OE NUMBER / OE	PRAVÁ / RIGHT / RECHTS / ПРАВАЯ	LEVÁ / LEFT / LINKS / ЛЕВАЯ	OSVĚTLENÍ SPZ / ILLUMINATION FOR NUMBERPLATE / KENNZEICHENLEUCHTE / ПОДСВЕТКА НОМЕРНОГО ЗНАКА	PŘIPOJENÍ / CONNECTION / ANSCHLUSS / СОЕДИНЕНИЕ
724593		■	■		KABEL - 1 m CABLE - 1 m KABEL - 1 m Кабель - 1 м

LCG LED Modul / LCG LED Control-Gear /
LCG LED Kontrolle-Gang / LCG светодиодный модуль управления

721788

12 V



721789

24 V

SVĚTLO KONCOVÉ, BRZDOVÉ, SMĚROVÉ / REAL LAMP, BRAKING, DIRECTIONAL /
LICHT ENDE, BREMSEN, RICHTUNGS / ЛЕГКИЙ КОНЕЦ, ТОРМОЗА, НАПРАВЛЕННЫЙ /

9-33V

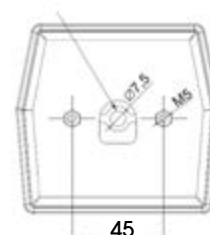
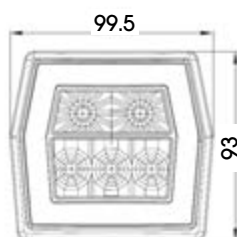

KÓD / ORDER CODE / BESTELL NR. / КОД	OE / OE NUMBER / OE NUMBER / OE	PRAVÁ / RIGHT / RECHTS / ПРАВАЯ	LEVÁ / LEFT / LINKS / ЛЕВАЯ	OSVĚTLENÍ SPZ / ILLUMINATION FOR NUMBERPLATE / KENNZEICHENLEUCHTE / ПОДСВЕТКА НОМЕРНОГО ЗНАКА	PŘIPOJENÍ / CONNECTION / ANSCHLUSS / СОЕДИНЕНИЕ
724592		■	■	■	KABEL - 1 m CABLE - 1 m KABEL - 1 m Кабель - 1 м

LCG LED Modul / LCG LED Control-Gear /
LCG LED Kontrolle-Gang / LCG светодиодный модуль управления

721788

12 V



721789

24 V

ZADNÍ SKUPINOVÉ SVÍTLILNY / REAR LAMPS / HECKLEUCHTEN / ЗАДНИЕ ФОНАРИ

SVĚTLO KONCOVÉ, BRZDOVÉ, SMĚROVÉ / REAL LAMP, BRAKING, DIRECTIONAL /
LICHT ENDE, BREMSSEN, RICHTUNGS / ЛЕГКИЙ КОНЕЦ, ТОРМОЗА, НАПРАВЛЕННЫЙ /

9-33V

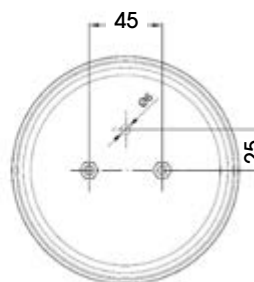
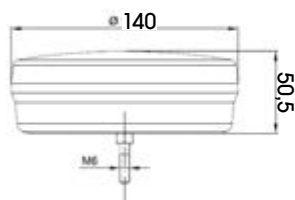

KÓD / ORDER CODE / BESTELL NR. / КОД	OE / OE NUMBER / OE NUMMER / OE	PRAVÁ / RIGHT / RECHTS / ПРАВАЯ	LEVÁ / LEFT / LINKS / ЛЕВАЯ	OSVĚTLENÍ SPZ / ILLUMINATION FOR NUMBERPLATE / KENNZEICHENLEUCHTE / ПОДСВЕТКА НОМЕРНОГО ЗНАКА	PŘIPOJENÍ / CONNECTION / ANSCHLUSS / СОЕДИНЕНИЕ
724532		■	■		KABEL - 1 m CABLE - 1 m KABEL - 1 m Кабель - 1 м

LCG LED Modul / LCG LED Control-Gear /
LCG LED Kontrolle-Gang / LCG светодиодный модуль управления

721788	12 V	
721789	24 V	

SVĚTLO KONCOVÉ, BRZDOVÉ, SMĚROVÉ / REAL LAMP, BRAKING, DIRECTIONAL /
LICHT ENDE, BREMSSEN, RICHTUNGS / ЛЕГКИЙ КОНЕЦ, ТОРМОЗА, НАПРАВЛЕННЫЙ

9-33V

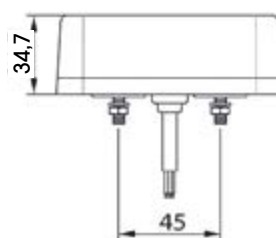
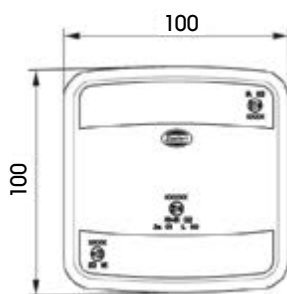

KÓD / ORDER CODE / BESTELL NR. / КОД	OE / OE NUMBER / OE NUMMER / OE	PRAVÁ / RIGHT / RECHTS / ПРАВАЯ	LEVÁ / LEFT / LINKS / ЛЕВАЯ	OSVĚTLENÍ SPZ / ILLUMINATION FOR NUMBERPLATE / KENNZEICHENLEUCHTE / ПОДСВЕТКА НОМЕРНОГО ЗНАКА	PŘIPOJENÍ / CONNECTION / ANSCHLUSS / СОЕДИНЕНИЕ
722136		■	■		KABEL - 0,5 m CABLE - 0,5 m KABEL - 0,5 m Кабель - 0,5 м

LCG LED Modul / LCG LED Control-Gear /
LCG LED Kontrolle-Gang / LCG светодиодный модуль управления

721788	12 V	
721789	24 V	

Important notice: part of other producers are only mentioned for comparison purposes.

ZADNÍ SKUPINOVÉ SVÍTILNY / REAR LAMPS / HECKLEUCHTEN / ЗАДНИЕ ФОНАРИ

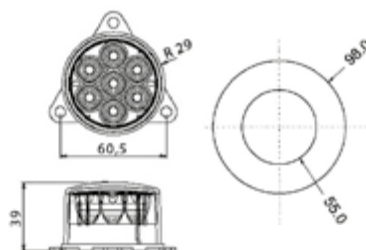
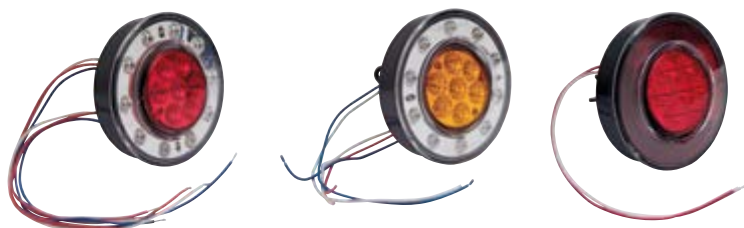

9-33V



KÓD / ORDER CODE / BESTELL NR. / КОД		PRAVÁ / RIGHT / RECHTS / ПРАВАЯ	LEVÁ / LEFT / LINKS / ЛЕВАЯ	12 V	24V	PŘIJOJENÍ / CONNECTION / ANSCHLUSS / СОЕДИНЕНИЕ
721777 SMĚROVKA / FRONT INDICATOR / BLINKLEUCHTE / УКАЗАТЕЛЬ ПОВОРОТА		<input checked="" type="checkbox"/>	<input checked="" type="checkbox"/>	<input checked="" type="checkbox"/>		KABEL - 0,2 m CABLE - 0,2 m KABEL - 0,2 m Кабель - 0,2 м
721778 SMĚROVKA / FRONT INDICATOR / BLINKLEUCHTE / УКАЗАТЕЛЬ ПОВОРОТА		<input checked="" type="checkbox"/>	<input checked="" type="checkbox"/>		<input checked="" type="checkbox"/>	KABEL - 0,2 m CABLE - 0,2 m KABEL - 0,2 m Кабель - 0,2 м
721769 KONCOVÁ - BRZDOVÁ / TAIL - STOP / SCHLUSS - BREMS / ЗАДНЯЯ ФАРА - ЛАМПА СИГНАЛА СТОП / ТОРМАЖЕНИЯ		<input checked="" type="checkbox"/>	<input checked="" type="checkbox"/>	<input checked="" type="checkbox"/>	<input checked="" type="checkbox"/>	KABEL - 0,2 m CABLE - 0,2 m KABEL - 0,2 m Кабель - 0,2 м
721774 MLHOVKA / REAR FOG LAMP / NEBELSCHLUSSLEUCHTE / ПРОТИВОТУМАННАЯ ЛАМПА		<input checked="" type="checkbox"/>	<input checked="" type="checkbox"/>	<input checked="" type="checkbox"/>	<input checked="" type="checkbox"/>	KABEL - 0,2 m CABLE - 0,2 m KABEL - 0,2 m Кабель - 0,2 м
721776 ZPÁTEČKA / REVERSING LAMP / RÜCKFAHRLEUCHTE / ФОНАРЬ ЗАДНЕГО ХОДА		<input checked="" type="checkbox"/>	<input checked="" type="checkbox"/>	<input checked="" type="checkbox"/>	<input checked="" type="checkbox"/>	KABEL - 0,2 m CABLE - 0,2 m KABEL - 0,2 m Кабель - 0,2 м
721779 SMĚROVKA / FRONT INDICATOR / BLINKLEUCHTE / УКАЗАТЕЛЬ ПОВОРОТА		<input checked="" type="checkbox"/>	<input checked="" type="checkbox"/>	<input checked="" type="checkbox"/>		KABEL - 0,2 m CABLE - 0,2 m KABEL - 0,2 m Кабель - 0,2 м
721780 SMĚROVKA / FRONT INDICATOR / BLINKLEUCHTE / УКАЗАТЕЛЬ ПОВОРОТА		<input checked="" type="checkbox"/>	<input checked="" type="checkbox"/>		<input checked="" type="checkbox"/>	KABEL - 0,2 m CABLE - 0,2 m KABEL - 0,2 m Кабель - 0,2 м
721770 KONCOVÁ - BRZDOVÁ / TAIL - STOP / SCHLUSS - BREMS / ЗАДНЯЯ ФАРА - ЛАМПА СИГНАЛА СТОП / ТОРМАЖЕНИЯ		<input checked="" type="checkbox"/>	<input checked="" type="checkbox"/>	<input checked="" type="checkbox"/>		KABEL - 0,2 m CABLE - 0,2 m KABEL - 0,2 m Кабель - 0,2 м
721771 KONCOVÁ - BRZDOVÁ / TAIL - STOP / SCHLUSS - BREMS / ЗАДНЯЯ ФАРА - ЛАМПА СИГНАЛА СТОП / ТОРМАЖЕНИЯ		<input checked="" type="checkbox"/>	<input checked="" type="checkbox"/>		<input checked="" type="checkbox"/>	KABEL - 0,2 m CABLE - 0,2 m KABEL - 0,2 m Кабель - 0,2 м
721781 ODRAZKA / REFLEX REFLECTOR / RÜCKSTRAHLER / СВЕТООТРАЖАТЕЛЬ		<input checked="" type="checkbox"/>	<input checked="" type="checkbox"/>			

LCG LED MODUL / LCG LED CONTROL - GEAR /
LCG LED KONTROLLE - GANG / LCG СВЕТОДИОДНЫЙ МОДУЛЬ УПРАВЛЕНИЯ

LCG LED MODUL / LCG LED CONTROL - GEAR /
LCG LED KONTROLLE - GANG / LCG СВЕТОДИОДНЫЙ МОДУЛЬ УПРАВЛЕНИЯ

721788

12 V



721789

24 V



ZADNÍ SKUPINOVÉ SVÍTILNY / REAR LAMPS / HECKLEUCHTEN / ЗАДНИЕ ФОНАРИ

ZPÁTEČKA / REVERSING LAMP / RÜCKFAHRLEUCHE / ФОНАРЬ ЗАДНЕГО ХОДА

9-33V LED

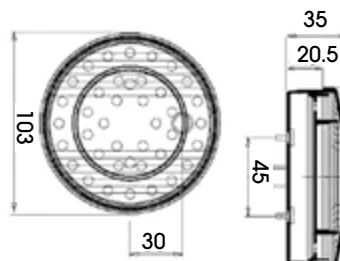

KÓD / ORDER CODE / BESTELL NR. / КОД	OE / OE NUMBER / OE NUMMER / OE	PRAVÁ / RIGHT / RECHTS / ПРАВАЯ	LEVÁ / LEFT / LINKS / ЛЕВАЯ	12 V	24V	PŘIPOJENÍ / CONNECTION / ANSCHLUSS / СОЕДИНЕНИЕ
722549		■	■		■	KABEL / CABLE / КАБЕЛЬ / Кабель - 0,9 m

LCG LED MODUL / LCG LED CONTROL-GEAR /
LCG LED KONTROLLE-GANG / LCG СВЕТОДИОДНЫЙ МОДУЛЬ УПРАВЛЕНИЯ

LCG LED MODUL / LCG LED CONTROL-GEAR /
LCG LED KONTROLLE-GANG / LCG СВЕТОДИОДНЫЙ МОДУЛЬ УПРАВЛЕНИЯ

721788

12 V



721789

24 V



KONCOVÁ - MLHOVÁ / TAIL - FOG / SCHLUSS - NEBELSCHLUSSLECHTE / ЗАДНЯЯ-ПРОТИВОТУМАННАЯ

9-33V LED

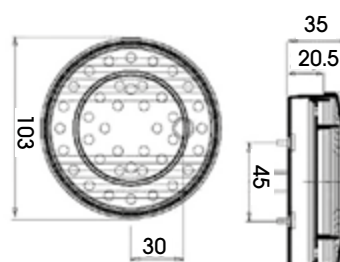

KÓD / ORDER CODE / BESTELL NR. / КОД	OE / OE NUMBER / OE NUMMER / OE	PRAVÁ / RIGHT / RECHTS / ПРАВАЯ	LEVÁ / LEFT / LINKS / ЛЕВАЯ	12 V	24V	PŘIPOJENÍ / CONNECTION / ANSCHLUSS / СОЕДИНЕНИЕ
722121		■	■		■	KABEL / CABLE / КАБЕЛЬ / Кабель - 0,9 m

LCG LED MODUL / LCG LED CONTROL-GEAR /
LCG LED KONTROLLE-GANG / LCG СВЕТОДИОДНЫЙ МОДУЛЬ УПРАВЛЕНИЯ

LCG LED MODUL / LCG LED CONTROL-GEAR /
LCG LED KONTROLLE-GANG / LCG СВЕТОДИОДНЫЙ МОДУЛЬ УПРАВЛЕНИЯ

721788

12 V



721789

24 V



ZADNÍ SKUPINOVÉ SVÍTLILNY / REAR LAMPS / HECKLEUCHTEN / ЗАДНИЕ ФОНАРИ

LED KONCOVÁ - BRZDOVÁ - SMĚROVKA / LED TAIL - STOP - FLASHER LAMP / LED SCHLUSS - BREMS - BLINKLECHUTE /
СВЕТОДИОДНАЯ ЗАДНЯЯ ФАРА - ЛАМПА СИГНАЛА СТОП/ТОРМАЖЕНИЯ - УКАЗАТЕЛЬ ПОВОРОТА

9-33V

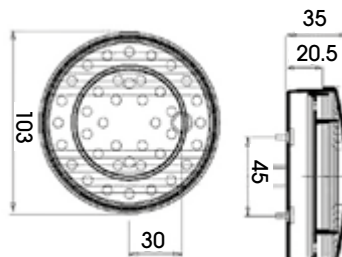

KÓD / ORDER CODE / BESTELL NR. / КОД	OE / OE NUMBER / OE NUMMER / OE	PRAVÁ / RIGHT / RECHTS / ПРАВАЯ	LEVÁ / LEFT / LINKS / ЛЕВАЯ	12 V	24V	PŘIPOJENÍ / CONNECTION / ANSCHLUSS / СОЕДИНЕНИЕ	
722115		■	■	■		KABEL - 0,9 m CABLE - 0,9 m KABEL - 0,9 m Кабель - 0,9 м	
722124		■	■		■		
LCG LED Modul / LCG LED Control-Gear / LCG LED Kontrolle-Gang / LCG светодиодный модуль управления			LCG LED Modul / LCG LED Control-Gear / LCG LED Kontrolle-Gang / LCG светодиодный модуль управления				
721788	12 V			721789	24 V		

LED KONCOVÁ - BRZDOVÁ - SMĚROVKA / LED TAIL - STOP - FLASHER LAMP / LED SCHLUSS - BREMS - BLINKLECHUTE /
СВЕТОДИОДНАЯ ЗАДНЯЯ ФАРА - ЛАМПА СИГНАЛА СТОП/ТОРМАЖЕНИЯ - УКАЗАТЕЛЬ ПОВОРОТА

9-33V

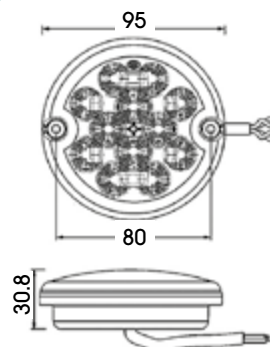

KÓD / ORDER CODE / BESTELL NR. / КОД	OE / OE NUMBER / OE NUMMER / OE	PRAVÁ / RIGHT / RECHTS / ПРАВАЯ	LEVÁ / LEFT / LINKS / ЛЕВАЯ	12 V	24V	PŘIPOJENÍ / CONNECTION / ANSCHLUSS / СОЕДИНЕНИЕ	
722116		■	■	■	■	KABEL - 0,9 m CABLE - 0,9 m KABEL - 0,9 m Кабель - 0,9 м	
LCG LED Modul / LCG LED Control-Gear / LCG LED Kontrolle-Gang / LCG светодиодный модуль управления			LCG LED Modul / LCG LED Control-Gear / LCG LED Kontrolle-Gang / LCG светодиодный модуль управления				
721788	12 V			721789	24 V		

ZADNÍ SKUPINOVÉ SVÍTILNY / REAR LAMPS / HECKLEUCHTEN / ЗАДНИЕ ФОНАРИ

LED KONCOVÁ - ZPÁTEČKA / LED TAIL - REVERSING LAMP / LED SCHLUSS - RÜCKFAHRLEUCHE / СВЕТОДИОДНАЯ ЗАДНЯЯ ФАРА - ФОНАРЬ ЗАДНЕГО ХОДА

9-33V

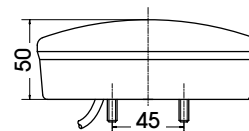
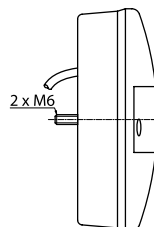
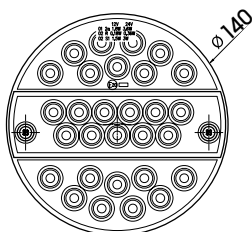

KÓD / ORDER CODE / BESTELL NR. / КОД	OE / OE NUMBER / OE NUMMER / OE	PRAVÁ / RIGHT / RECHTS / ПРАВАЯ	LEVÁ / LEFT / LINKS / ЛЕВАЯ	OSVĚTLENÍ SPZ / ILLUMINATION FOR NUMBERPLATE / KENNZEICHENLEUCHE / ПОДСВЕТКА НОМЕРНОГО ЗНАКА	PŘIPOJENÍ / CONNECTION / ANSCHLUSS / СОЕДИНЕНИЕ		
726737		■	■		KABEL - 2 m CABLE - 2 m KABEL - 2 m Кабель - 2 м		
LCG LED Modul / LCG LED Control-Gear / LCG LED Kontrolle-Gang / LCG светодиодный модуль управления				LCG LED Modul / LCG LED Control-Gear / LCG LED Kontrolle-Gang / LCG светодиодный модуль управления			
721788	12 V			721789	24 V		

LED KONCOVÁ - BRZDOVÁ - SMĚROVKA / LED TAIL - STOP - FLASHER LAMP / LED SCHLUSS - BREMS - BLINKLEUCHE / СВЕТОДИОДНАЯ ЗАДНЯЯ ФАРА - ЛАМПА СИГНАЛА СТОП/ТОРМАЖЕНИЯ - УКАЗАТЕЛЬ ПОВОРОТА

9-33V

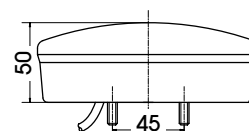
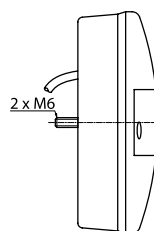
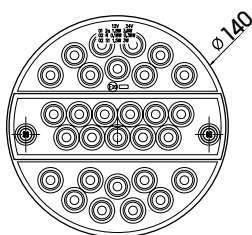

KÓD / ORDER CODE / BESTELL NR. / КОД	OE / OE NUMBER / OE NUMMER / OE	PRAVÁ / RIGHT / RECHTS / ПРАВАЯ	LEVÁ / LEFT / LINKS / ЛЕВАЯ	OSVĚTLENÍ SPZ / ILLUMINATION FOR NUMBERPLATE / KENNZEICHENLEUCHE / ПОДСВЕТКА НОМЕРНОГО ЗНАКА	PŘIPOJENÍ / CONNECTION / ANSCHLUSS / СОЕДИНЕНИЕ		
726736		■	■		KABEL - 2 m CABLE - 2 m KABEL - 2 m Кабель - 2 м		
LCG LED Modul / LCG LED Control-Gear / LCG LED Kontrolle-Gang / LCG светодиодный модуль управления				LCG LED Modul / LCG LED Control-Gear / LCG LED Kontrolle-Gang / LCG светодиодный модуль управления			
721788	12 V			721789	24 V		

Important notice: part of other producers are only mentioned for comparison purposes.

ZADNÍ SKUPINOVÉ SVÍTLILNY / REAR LAMPS / HECKLEUCHTEN / ЗАДНИЕ ФОНАРИ

LED KONCOVÁ - BRZDOVÁ - SMĚROVKA / LED TAIL - STOP - FLASHER LAMP / LED SCHLUSS - BREMS - BLINKLECHUTE /
СВЕТОДИОДНАЯ ЗАДНЯЯ ФАРА-ЛАМПА СИГНАЛА СТОП/ТОРМАЖЕНИЯ-УКАЗАТЕЛЬ ПОВОРОТА

9-33V

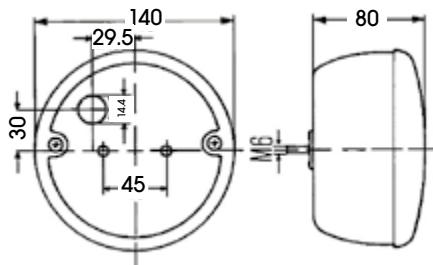

KÓD / ORDER CODE / BESTELL NR. / КОД	OE / OE NUMBER / OE NUMBER / OE	PRAVÁ / RIGHT / RECHTS / ПРАВАЯ	LEVÁ / LEFT / LINKS / ЛЕВАЯ	OSVĚTLENÍ SPZ / ILLUMINATION FOR NUMBERPLATE / KENNZEICHENLEUCHTE / ПОДСВЕТКА НОМЕРНОГО ЗНАКА	PŘIPOJENÍ / CONNECTION / ANSCHLUSS / СОЕДИНЕНИЕ
726735	D13816	■	■		
LCG LED Modul / LCG LED Control-Gear / LCG LED Kontrolle-Gang / LCG светодиодный модуль управления			LCG LED Modul / LCG LED Control-Gear / LCG LED Kontrolle-Gang / LCG светодиодный модуль управления		
721788	12 V		721789	24 V	

MLHOVKA / REAR FOG LAMP / NEBELSCHLUSSLEUCHTE / ПРОТИВОТУМАННАЯ ФАРА

9-33V

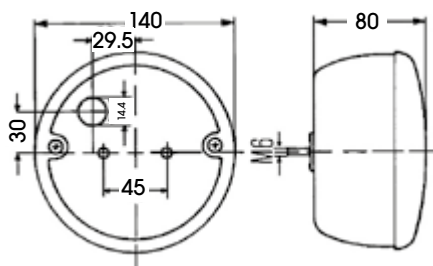





KÓD / ORDER CODE / BESTELL NR. / КОД	OE / OE NUMBER / OE NUMBER / OE	PRAVÁ / RIGHT / RECHTS / ПРАВАЯ	LEVÁ / LEFT / LINKS / ЛЕВАЯ	OSVĚTLENÍ SPZ / ILLUMINATION FOR NUMBERPLATE / KENNZEICHENLEUCHTE / ПОДСВЕТКА НОМЕРНОГО ЗНАКА	PŘIPOJENÍ / CONNECTION / ANSCHLUSS / СОЕДИНЕНИЕ
725980	810/03/00	■	■		
LCG LED Modul / LCG LED Control-Gear / LCG LED Kontrolle-Gang / LCG светодиодный модуль управления			LCG LED Modul / LCG LED Control-Gear / LCG LED Kontrolle-Gang / LCG светодиодный модуль управления		
721788	12 V		721789	24 V	

ZADNÍ SKUPINOVÉ SVÍTILNY / REAR LAMPS / HECKLEUCHTEN / ЗАДНИЕ ФОНАРИ

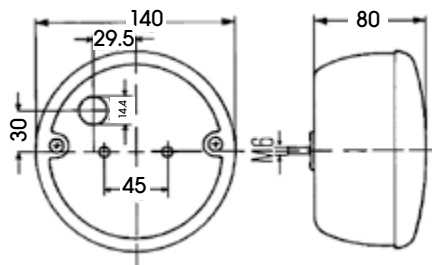
LED KONCOVÁ – BRZDOVÁ – SMĚROVKA / LED TAIL – STOP – FLASHER LAMP / LED SCHLUSS – BREMS – BLINKLECHUTE /
СВЕТОДИОДНАЯ ЗАДНЯЯ ФАРА – ЛАМПА СИГНАЛА СТОП/ТОРМАЖЕНИЯ – УКАЗАТЕЛЬ ПОВОРОТА

9-33V





KÓD / ORDER CODE / BESTELL NR. / КОД	OE / OE NUMBER / OE NUMMER / OE	PRAVÁ / RIGHT / RECHTS / ПРАВАЯ	LEVÁ / LEFT / LINKS / ЛЕВАЯ	OSVĚTLENÍ SPZ / ILLUMINATION FOR NUMBERPLATE / KENNZEICHENLEUCHTE / ПОДСВЕТКА НОМЕРНОГО ЗНАКА	PŘIPOJENÍ / CONNECTION / ANSCHLUSS / СОЕДИНЕНИЕ	
727327		■	■			
LCG LED Modul / LCG LED Control-Gear / LCG LED Kontrolle-Gang / LCG светодиодный модуль управления			LCG LED Modul / LCG LED Control-Gear / LCG LED Kontrolle-Gang / LCG светодиодный модуль управления			
721788	12 V			721789	24 V	

LED KONCOVÁ – BRZDOVÁ – SMĚROVKA / LED TAIL – STOP – FLASHER LAMP / LED SCHLUSS – BREMS – BLINKLECHUTE /
СВЕТОДИОДНАЯ ЗАДНЯЯ ФАРА – ЛАМПА СИГНАЛА СТОП/ТОРМАЖЕНИЯ – УКАЗАТЕЛЬ ПОВОРОТА

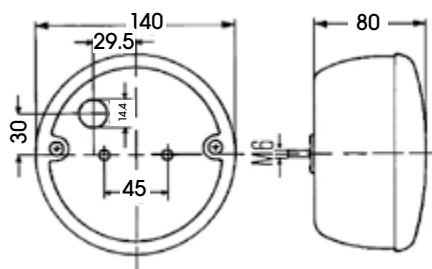
9-33V



KÓD / ORDER CODE / BESTELL NR. / КОД	OE / OE NUMBER / OE NUMMER / OE	PRAVÁ / RIGHT / RECHTS / ПРАВАЯ	LEVÁ / LEFT / LINKS / ЛЕВАЯ	OSVĚTLENÍ SPZ / ILLUMINATION FOR NUMBERPLATE / KENNZEICHENLEUCHTE / ПОДСВЕТКА НОМЕРНОГО ЗНАКА	PŘIPOJENÍ / CONNECTION / ANSCHLUSS / СОЕДИНЕНИЕ	
727326		■	■			
LCG LED Modul / LCG LED Control-Gear / LCG LED Kontrolle-Gang / LCG светодиодный модуль управления			LCG LED Modul / LCG LED Control-Gear / LCG LED Kontrolle-Gang / LCG светодиодный модуль управления			
721788	12 V			721789	24 V	

Important notice: part of other producers are only mentioned for comparison purposes.

ZADNÍ SKUPINOVÉ SVÍTLILNY / REAR LAMPS / HECKLEUCHTEN / ЗАДНИЕ ФОНАРИ

MLHOVKA / REAR FOG LAMP / NEBELSCHLUSSLEUCHTE / ПРОТИВОТУМАННАЯ ФАРА

9-33V

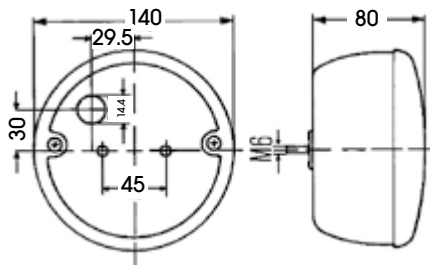

KÓD / ORDER CODE / BESTELL NR. / КОД	OE / OE NUMBER / OE NUMMER / OE	PRAVÁ / RIGHT / RECHTS / ПРАВАЯ	LEVÁ / LEFT / LINKS / ЛЕВАЯ	OSVĚTLENÍ SPZ / ILLUMINATION FOR NUMBERPLATE / KENNZEICHENLEUCHTE / ПОДСВЕТКА НОМЕРНОГО ЗНАКА	PŘIPOJENÍ / CONNECTION / ANSCHLUSS / СОЕДИНЕНИЕ	
727009		■	■			
LCG LED Modul / LCG LED Control-Gear / LCG LED Kontrolle-Gang / LCG светодиодный модуль управления			LCG LED Modul / LCG LED Control-Gear / LCG LED Kontrolle-Gang / LCG светодиодный модуль управления			
721788	12 V			721789	24 V	

ZPÁTEČKA / REVERSING LAMP / RÜCKFAHRLEUCHTE / ФОНАРЬ ЗАДНЕГО ХОДА

9-33V

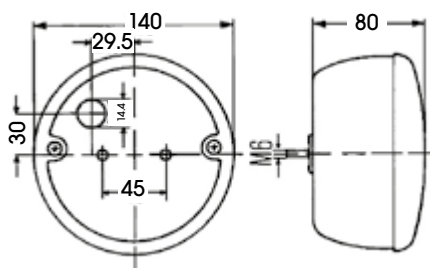



KÓD / ORDER CODE / BESTELL NR. / КОД	OE / OE NUMBER / OE NUMMER / OE	PRAVÁ / RIGHT / RECHTS / ПРАВАЯ	LEVÁ / LEFT / LINKS / ЛЕВАЯ	OSVĚTLENÍ SPZ / ILLUMINATION FOR NUMBERPLATE / KENNZEICHENLEUCHTE / ПОДСВЕТКА НОМЕРНОГО ЗНАКА	PŘIPOJENÍ / CONNECTION / ANSCHLUSS / СОЕДИНЕНИЕ	
722228		■	■			
LCG LED Modul / LCG LED Control-Gear / LCG LED Kontrolle-Gang / LCG светодиодный модуль управления			LCG LED Modul / LCG LED Control-Gear / LCG LED Kontrolle-Gang / LCG светодиодный модуль управления			
721788	12 V			721789	24 V	

ZADNÍ SKUPINOVÉ SVÍTLILNY / REAR LAMPS / HECKLEUCHTEN / ЗАДНИЕ ФОНАРИ

COUVACÍ, MLHOVÉ / REVERSE, FOG/ RÜCKWÄRTS, NEBEL / ОБРАТНАЯ, ТУМАН

9-33V LED



KÓD / ORDER CODE / BESTELL NR. / КОД	OE / OE NUMBER / OE NUMBER / OE	PRAVÁ / RIGHT / RECHTS / ПРАВАЯ	LEVÁ / LEFT / LINKS / ЛЕВАЯ	OSVĚTLENÍ SPZ / ILLUMINATION FOR NUMBERPLATE / KENNZEICHENLEUCHTE / ПОДСВЕТКА НОМЕРНОГО ЗНАКА	PŘIPOJENÍ / CONNECTION / ANSCHLUSS / СОЕДИНЕНИЕ	
725828		■	■		KABEL - 0,3 m CABLE - 0,3 m KABEL - 0,3 m Кабель - 0,3 м	
LCG LED Modul / LCG LED Control-Gear / LCG LED Kontrolle-Gang / LCG светодиодный модуль управления			LCG LED Modul / LCG LED Control-Gear / LCG LED Kontrolle-Gang / LCG светодиодный модуль управления			
721788	12 V			721789	24 V	



BRZDOVÁ, SMĚROVÁ, POZIČNÍ / STOP, FLASHER LAMP, TAIL /
BREMS, BLINKLECHUTE, SCHLUSS / ЛАМПА СИГНАЛА, СТОП, ТОРМОЖЕНИЯ

LED E

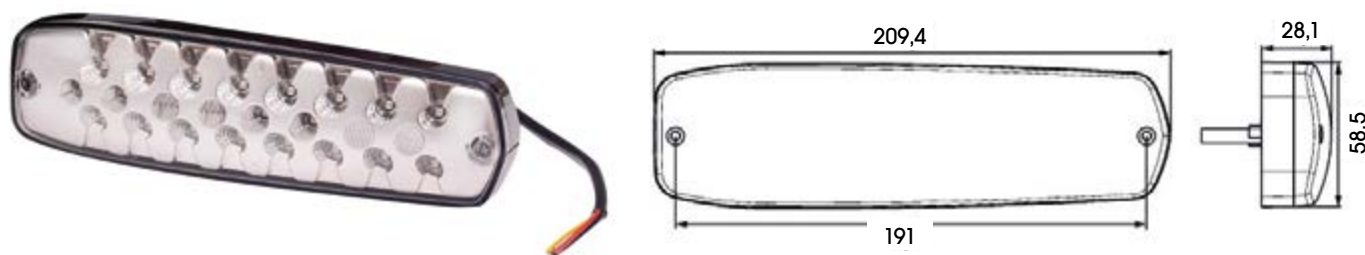

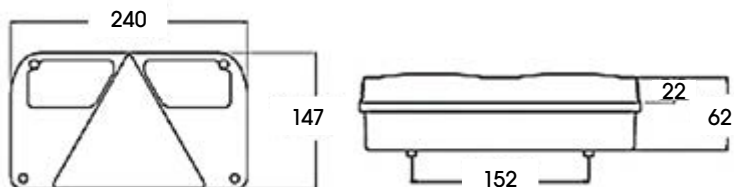

KÓD / ORDER CODE / BESTELL NR. / КОД	OE / OE NUMBER / OE NUMBER / OE	PRAVÁ / RIGHT / RECHTS / ПРАВАЯ	LEVÁ / LEFT / LINKS / ЛЕВАЯ	OSVĚTLENÍ SPZ / ILLUMINATION FOR NUMBERPLATE / KENNZEICHENLEUCHTE / ПОДСВЕТКА НОМЕРНОГО ЗНАКА	PŘIPOJENÍ / CONNECTION / ANSCHLUSS / СОЕДИНЕНИЕ
722301		■	■		KABEL - 0,5 m CABLE - 0,5 m KABEL - 0,5 m Кабель - 0,5 м

ZADNÍ SKUPINOVÉ SVÍTILNY / REAR LAMPS / HECKLEUCHTEN / ЗАДНИЕ ФОНАРИ

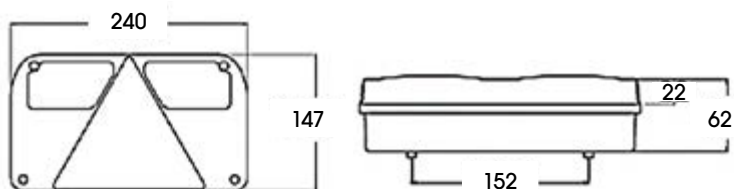

KÓD / ORDER CODE / BESTELL NR. / КОД	OE / OE NUMBER / OE NUMMER / OE	PRAVÁ / RIGHT / RECHTS / ПРАВАЯ	LEVÁ / LEFT / LINKS / ЛЕВАЯ	OSVĚTLENÍ SPZ / ILLUMINATION FOR NUMBERPLATE / KENNZEICHENLEUCHE / ПОДСВЕТКА НОМЕРНОГО ЗНАКА	PŘIPOJENÍ / CONNECTION / ANSCHLUSS / СОЕДИНЕНИЕ	
720178		■				
720179			■			
721280 KRYT / LENS / LICHTSCHEIBE / КРЫШКА		■				
721281 KRYT / LENS / LICHTSCHEIBE / КРЫШКА			■			
				722937	12V	P21 5W 12V, BAY15d
				722931	12V	P21W 12V, BA15s
				722938	24V	P21 5W 24V, BAY15d
				722932	24V	P21W 24V, BA15s



KÓD / ORDER CODE / BESTELL NR. / КОД	OE / OE NUMBER / OE NUMMER / OE	PRAVÁ / RIGHT / RECHTS / ПРАВАЯ	LEVÁ / LEFT / LINKS / ЛЕВАЯ	OSVĚTLENÍ SPZ / ILLUMINATION FOR NUMBERPLATE / KENNZEICHENLEUCHE / ПОДСВЕТКА НОМЕРНОГО ЗНАКА	PŘIPOJENÍ / CONNECTION / ANSCHLUSS / СОЕДИНЕНИЕ	
720176		■				
720177			■			
721280 KRYT / LENS / LICHTSCHEIBE / КРЫШКА		■				
721281 KRYT / LENS / LICHTSCHEIBE / КРЫШКА			■			
Opravná sada / Repair Kit / Anschlusssatz / Ремонтный комплект				722937	12V	P21 5W 12V, BAY15d
721493				722931	12V	P21W 12V, BA15s
				722938	24V	P21 5W 24V, BAY15d
				722932	24V	P21W 24V, BA15s



ZADNÍ SKUPINOVÉ SVÍTILNY / REAR LAMPS / HECKLEUCHTEN / ЗАДНИЕ ФОНАРИ

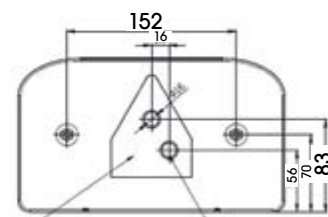
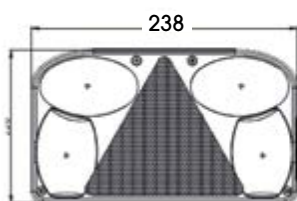

KÓD / ORDER CODE / BESTELL NR. / КОД	OE / OE NUMBER / OE NUMMER / OE	PRAVÁ / RIGHT / RECHTS / ПРАВАЯ	LEVÁ / LEFT / LINKS / ЛЕВАЯ	OSVĚTLENÍ SPZ / ILLUMINATION FOR NUMBERPLATE / KENNZEICHENLEUCHE / ПОДСВЕТКА НОМЕРНОГО ЗНАКА	PŘIJOJENÍ / CONNECTION / ANSCHLUSS / СОЕДИНЕНИЕ
725569		■		■	
725570			■	■	
725574 KRYT / LENS / LICHTSCHEIBE / КРЫШКА		■		■	
725576 KRYT / LENS / LICHTSCHEIBE / КРЫШКА			■	■	

722943	12V	R10W 12V, BA15s
722931	12V	P21W 12V, BA15s
722944	24V	R10W 24V, BA15s
722932	24V	P21W 24V, BA15s

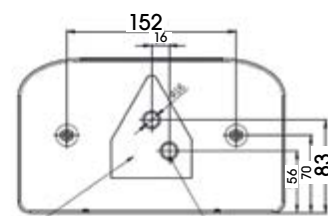
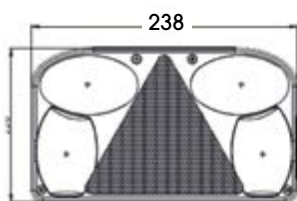

KÓD / ORDER CODE / BESTELL NR. / КОД	OE / OE NUMBER / OE NUMMER / OE	PRAVÁ / RIGHT / RECHTS / ПРАВАЯ	LEVÁ / LEFT / LINKS / ЛЕВАЯ	OSVĚTLENÍ SPZ / ILLUMINATION FOR NUMBERPLATE / KENNZEICHENLEUCHE / ПОДСВЕТКА НОМЕРНОГО ЗНАКА	PŘIJOJENÍ / CONNECTION / ANSCHLUSS / СОЕДИНЕНИЕ
725571		■			
725573			■		
725574 KRYT / LENS / LICHTSCHEIBE / КРЫШКА		■			
725576 KRYT / LENS / LICHTSCHEIBE / КРЫШКА			■		

722943	12V	R10W 12V, BA15s
722931	12V	P21W 12V, BA15s
722944	24V	R10W 24V, BA15s
722932	24V	P21W 24V, BA15s

Opravná sada / Repair Kit / Anschlusssatz / Ремонтный комплект

721760 LEVÁ / LEFT / LINKS / Левая		721800	1 m	
721761 PRAVÁ / RIGHT / RECHTS / Правая		721801	1 m	



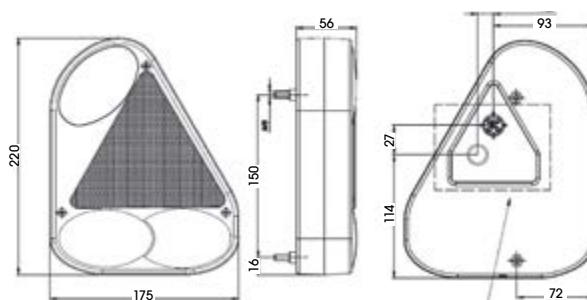

Important notice: part of other producers are only mentioned for comparison purposes.

ZADNÍ SKUPINOVÉ SVÍTLILNY / REAR LAMPS / НЕКЛЕУЧТЕН / ЗАДНИЕ ФОНАРИ

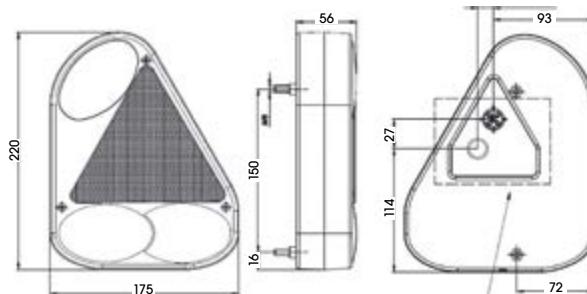

KÓD / ORDER CODE / BESTELL NR. / КОД	OE / OE NUMBER / OE NUMMER / OE	PRAVÁ / RIGHT / RECHTS / ПРАВАЯ	LEVÁ / LEFT / LINKS / ЛЕВАЯ	OSVĚTLENÍ SPZ / ILLUMINATION FOR NUMBERPLATE / KENNZEICHENLEUCHE / ПОДСВЕТКА НОМЕРНОГО ЗНАКА	PŘIPOJENÍ / CONNECTION / ANSCHLUSS / СОЕДИНЕНИЕ	
725578		■				
725579			■			
725582 - KRYT / LENS / LICHTSCHEIBE / КРЫШКА		■				
725583 - KRYT / LENS / LICHTSCHEIBE / КРЫШКА			■			
				722943	12V	R10W 12V, BA15s
				722931	12V	P21W 12V, BA15s
				722944	24V	R10W 24V, BA15s
				722932	24V	P21W 24V, BA15s





KÓD / ORDER CODE / BESTELL NR. / КОД	OE / OE NUMBER / OE NUMMER / OE	PRAVÁ / RIGHT / RECHTS / ПРАВАЯ	LEVÁ / LEFT / LINKS / ЛЕВАЯ	OSVĚTLENÍ SPZ / ILLUMINATION FOR NUMBERPLATE / KENNZEICHENLEUCHE / ПОДСВЕТКА НОМЕРНОГО ЗНАКА	PŘIPOJENÍ / CONNECTION / ANSCHLUSS / СОЕДИНЕНИЕ		
725580		■					
725581			■				
725582 - KRYT / LENS / LICHTSCHEIBE / КРЫШКА		■					
725583 - KRYT / LENS / LICHTSCHEIBE / КРЫШКА			■				
Opravná sada / Repair Kit / Anschlusssatz / Ремонтный комплект							
721760 LEVÁ / LEFT / LINKS / Левая		721800	1 m		722943	12V	R10W 12V, BA15s
721761 PRAVÁ / RIGHT / RECHTS / Правая		721801	1 m		722931	12V	P21W 12V, BA15s
					722944	24V	R10W 24V, BA15s
					722932	24V	P21W 24V, BA15s

ZADNÍ SKUPINOVÉ SVÍTILNY / REAR LAMPS / HECKLEUCHTEN / ЗАДНИЕ ФОНАРИ

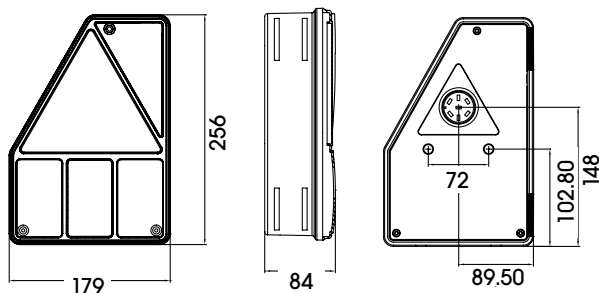

EARPOINT

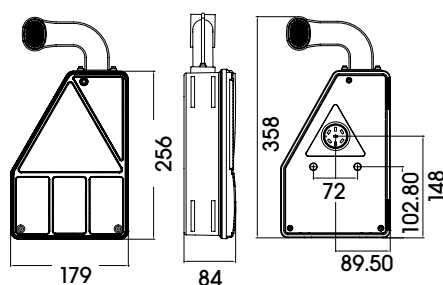

KÓD / ORDER CODE / BESTELL NR. / КОД	OE / OE NUMBER / OE NUMMER / OE	PRAVÁ / RIGHT / RECHTS / ПРАВАЯ	LEVÁ / LEFT / LINKS / ЛЕВАЯ	OSVĚTLENÍ SPZ / ILLUMINATION FOR NUMBERPLATE / KENNZEICHENLEUCHE / ПОДСВЕТКА НОМЕРНОГО ЗНАКА	PŘIPOJENÍ / CONNECTION / ANSCHLUSS / СОЕДИНЕНИЕ	
723971	24-4301-007	■				
723979	24-4101-007		■			
724864 - KRYT / LENS / LICHTSCHEIBE / КРЫШКА	18-8442-007	■				
724863 - KRYT / LENS / LICHTSCHEIBE / КРЫШКА	18-8440-007		■			
Opravná sada / Repair Kit / Anschlusssatz / Ремонтный комплект				722944	24V	R10W 24V, BA15s
				722932	24V	P21W 24V, BA15s
725506	13-5626-951					

EARPOINT



KÓD / ORDER CODE / BESTELL NR. / КОД	OE / OE NUMBER / OE NUMMER / OE	PRAVÁ / RIGHT / RECHTS / ПРАВАЯ	LEVÁ / LEFT / LINKS / ЛЕВАЯ	OSVĚTLENÍ SPZ / ILLUMINATION FOR NUMBERPLATE / KENNZEICHENLEUCHE / ПОДСВЕТКА НОМЕРНОГО ЗНАКА	PŘIPOJENÍ / CONNECTION / ANSCHLUSS / СОЕДИНЕНИЕ	
723980	24-4351-007	■				
723981	24-4151-007		■			
724864 - KRYT / LENS / LICHTSCHEIBE / КРЫШКА	18-8442-007	■				
724863 - KRYT / LENS / LICHTSCHEIBE / КРЫШКА	18-8440-007		■			
Opravná sada / Repair Kit / Anschlusssatz / Ремонтный комплект				722949	24V	T4W 24V, BA9s
				722944	24V	R10W 24V, BA15s
				722932	24V	P21W 24V, BA15s
725506	13-5626-951					

Important notice: part of other producers are only mentioned for comparison purposes.

MIDIPOINT I.

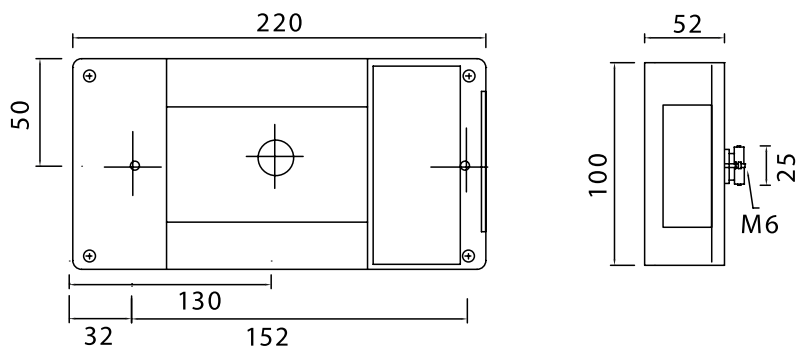

KÓD / ORDER CODE / BESTELL NR. / КОД	OE / OE NUMBER / OE NUMBER / OE	PRAVÁ / RIGHT / RECHTS / ПРАВАЯ	LEVÁ / LEFT / LINKS / ЛЕВАЯ	OSVĚTLENÍ SPZ / ILLUMINATION FOR NUMBERPLATE / KENNZEICHENLEUCHTE / ПОДСВЕТКА НОМЕРНОГО ЗНАКА	ZPÁTEČKA / REVERSING LAMP / RÜCKFAHRLEUCHTE / ФОНАРЬ ЗАДНЕГО ХОДА	MLHOVKA / REAR FOG LAMP / NEBEL. / ПРОТИВОТУМАННАЯ ФАРА
721194	24-6000-007	■	■	■		■
721195	24-6210-007	■	■	■	■	
721196	24-6002-507	■	■	■		■
721198 KRYT / LENS / LICHTSCHEIBE / Крышка	18-8460-007	■	■	■		■
721197 KRYT / LENS / LICHTSCHEIBE / Крышка	18-8462-107	■	■	■	■	

Opravná sada / Repair Kit / Anschlussatz / Ремонтный комплект		Připojení / Connection / Anschluss / Соединение				
721761 PRAVÁ / RIGHT / RECHTS / Правая	13-0523-044			722931	12V	P21W 12V, BA15s
721760 LEVÁ / LEFT / LINKS / Левая	13-0521-044			722937	12V	P21 5W 12V, BAY15d
				722950	12V	C5W 12V, SV8,5-8
				722932	24V	P21W 24V, BA15s
				722938	24V	P21 5W 24V, BAY15d
				722951	24V	C5W 24V, SV8,5-8

ZADNÍ SKUPINOVÉ SVÍTILNY / REAR LAMPS / HECKLEUCHTEN / ЗАДНИЕ ФОНАРИ

MIDIPOINT II.

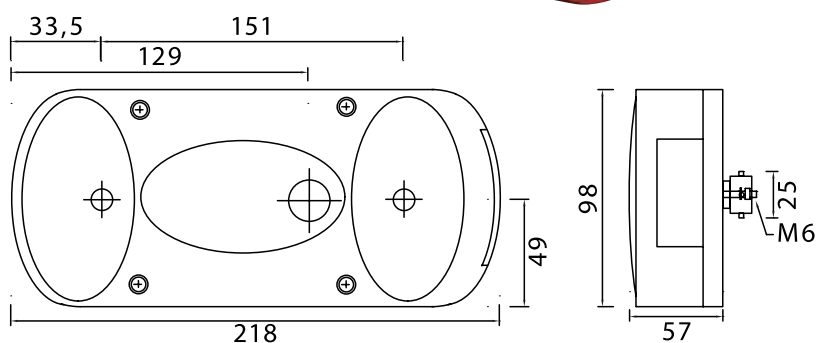

KÓD / ORDER CODE / BESTELL NR. / КОД	OE / OE NUMBER / OE NUMBER / OE	PRAVÁ / RIGHT / RECHTS / ПРАВАЯ	LEVÁ / LEFT / LINKS / ЛЕВАЯ	OSVĚTLENÍ SPZ / ILLUMINATION FOR NUMBERPLATE / KENNZEICHENLEUCHE / ПОДСВЕТКА НОМЕРНОГО ЗНАКА	ZPÁTEČKA / REVERSING LAMP / RÜCKFAHRLEUCHE / ФОНАРЬ ЗАДНЕГО ХОДА	MLHOVKA / REAR FOG LAMP / NEBEL / ПРОТИВОТУМАННАЯ ФАРА
725560	24-3000-007	■	■	■		■
725562	24-3210-007	■	■	■	■	
725563 KRYT / LENS / LICHTSCHEIBE / Крышка	18-8430-007	■	■	■		
725564 KRYT / LENS / LICHTSCHEIBE / Крышка	18-8432-107	■	■	■	■	■

Opravná sada / Repair Kit / Anschlusssatz / Ремонтный комплект			Připojení / Connection / Anschluss / Соединение			
721761 PRAVÁ / RIGHT / RECHTS / Правая	13-0523-044			722931	12V	P21W 12V, BA15s
721760 LEVÁ / LEFT / LINKS / Левая	13-0521-044			722937	12V	P21 5W 12V, BAY15d
				722950	12V	C5W 12V, SV8,5-8
				722932	24V	P21W 24V, BA15s
				722938	24V	P21 5W 24V, BAY15d
				722951	24V	C5W 24V, SV8,5-8

Important notice: part of other producers are only mentioned for comparison purposes.

MULTIPOINT II.

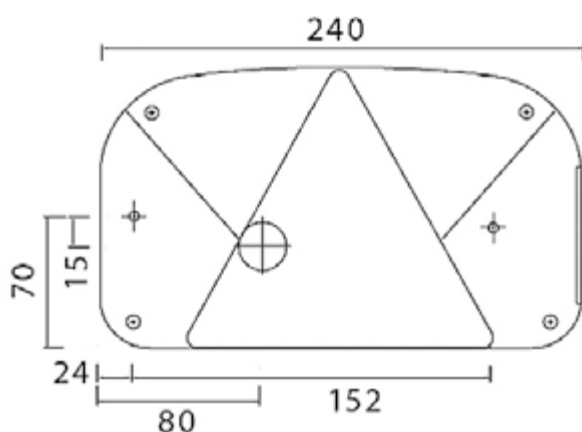

KÓD / ORDER CODE / BESTELL NR. / КОД	OE / OE NUMBER / OE NUMMER / OE	PRÁVÁ / RIGHT / RECHTS / ПРАВАЯ	LEVÁ / LEFT / LINKS / ЛЕВАЯ	OSVĚTLENÍ SPZ / ILLUMINATION FOR NUMBERPLATE / KENNZEICHENLEUCHTE / ПОДСВЕТКА НОМЕРНОГО ЗНАКА	ZPÁTEČKA / REVERSING LAMP / RÜCKFAHRLEUCHTE / ФОНАРЬ ЗАДНЕГО ХОДА	MLHOVKA / REAR FOG LAMP / NEBEL / ПРОТИВОТУМАННАЯ ФАРА
722010	24-7200-007	■		■		
722007	24-7210-007	■		■	■	
722011	24-7000-007		■	■		■
722009 KRYT / LENS / LICHTSCHEIBE / Крышка	18-8470-007	■	■			

Opravná sada / Repair Kit / Anschlussatz / Ремонтный комплект		Připojení / Connection / Anschluss / Соединение				
721761 PRÁVÁ / RIGHT / RECHTS / Правая	13-0523-044			722931	12V	P21W 12V, BA15s
721760 LEVÁ / LEFT / LINKS / Левая	13-0521-044			722937	12V	P21 5W 12V, BAY15d
				722950	12V	C5W 12V, SV8,5-8
				722932	24V	P21W 24V, BA15s
				722938	24V	P21 5W 24V, BAY15d
				722951	24V	C5W 24V, SV8,5-8

ZADNÍ SKUPINOVÉ SVÍTILNY / REAR LAMPS / HECKLEUCHTEN / ЗАДНИЕ ФОНАРИ

MIDIPOINT III.

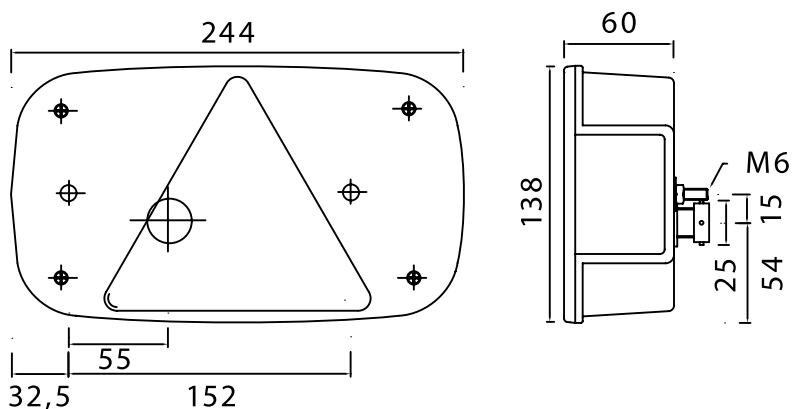
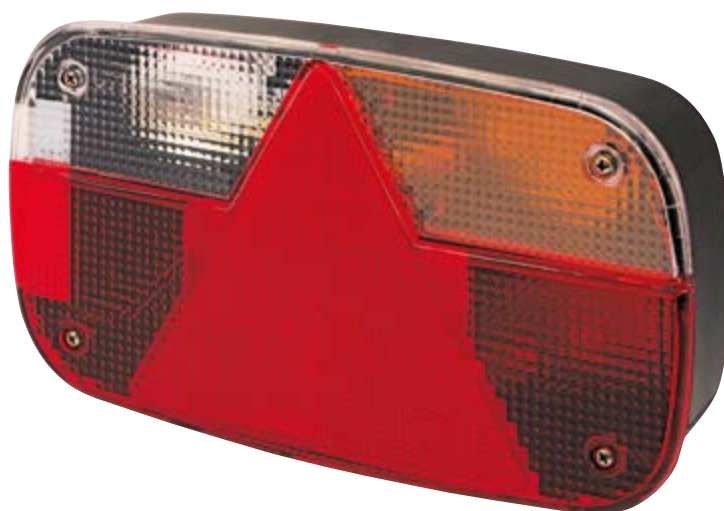

KÓD / ORDER CODE / BESTELL NR. / КОД	OE / OE NUMBER / OE NUMMER / OE	PRAVÁ / RIGHT / RECHTS / ПРАВАЯ	LEVÁ / LEFT / LINKS / ЛЕВАЯ	OSVĚTLENÍ SPZ / ILLUMINATION FOR NUMBERPLATE / KENNZEICHENLEUCHTE / ПОДСВЕТКА НОМЕРНОГО ЗНАКА	ZPÁTEČKA / REVERSING LAMP / RÜCKFAHRLEUCHTE / ФОНАРЬ ЗАДНЕГО ХОДА	MLHOVKA / REAR FOG LAMP / NEBEL / ПРОТИВОТУМАННАЯ ФАРА
722014	24-8210-007	■		■	■	
722015	24-8000-007		■	■		■
722016 KRYT / LENS / LICHTSCHEIBE / Крышка	18-8480-007	■	■			

Opravná sada / Repair Kit / Anschlusssatz / Ремонтный комплект			Připojení / Connection / Anschluss / Соединение			
721761 PRAVÁ / RIGHT / RECHTS / Правая	13-0523-044			722931	12V	P21W 12V, BA15s
721760 LEVÁ / LEFT / LINKS / Левая	13-0521-044			722937	12V	P21 5W 12V, BAY15d
				722950	12V	C5W 12V, SV8,5-8
				722932	24V	P21W 24V, BA15s
				722938	24V	P21 5W 24V, BAY15d
				722951	24V	C5W 24V, SV8,5-8

Important notice: part of other producers are only mentioned for comparison purposes.

ZADNÍ SKUPINOVÉ SVÍTLILNY / REAR LAMPS / HECKLEUCHTEN / ЗАДНИЕ ФОНАРИ

MIDIPOINT I.

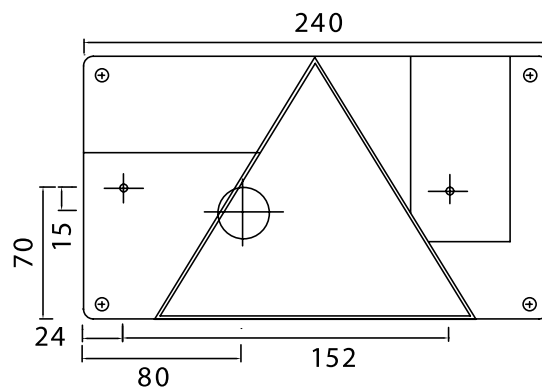

KÓD / ORDER CODE / BESTELL NR. / КОД	OE / OE NUMBER / OE NUMBER / OE	PRAVÁ / RIGHT / RECHTS / ПРАВАЯ	LEVÁ / LEFT / LINKS / ЛЕВАЯ	OSVĚTLENÍ SPZ / ILLUMINATION FOR NUMBERPLATE / KENNZEICHENLEUCHE / ПОДСВЕТКА НОМЕРНОГО ЗНАКА	ZPÁTEČKA / REVERSING LAMP / RÜCKFAHRLEUCHE / ФОНАРЬ ЗАДНЕГО ХОДА	MLHOVKA / REAR FOG LAMP / NEBEL / ПРОТИВОТУМАННАЯ ФАРА
721756	24-5210-007	■		■	■	
721758	24-5200-007	■		■		
721754	24-5000-007		■	■		■
721759 KRYT / LENS / LICHTSCHEIBE / Крышка	18-8452-007	■		■		
721757 KRYT / LENS / LICHTSCHEIBE / Крышка	18-8452-107	■		■	■	
721755 KRYT / LENS / LICHTSCHEIBE / Крышка	18-8450-007		■	■		■

Opravná sada / Repair Kit / Anschlussatz / Ремонтный комплект	
721761 PRAVÁ / RIGHT / RECHTS / Правая	13-0523-044 
721760 LEVÁ / LEFT / LINKS / Левая	13-0521-044 



722931	12V	P21W 12V, BA15s
722937	12V	P21 5W 12V, BAY15d
722950	12V	C5W 12V, SV8,5-8
722932	24V	P21W 24V, BA15s
722938	24V	P21 5W 24V, BAY15d
722951	24V	C5W 24V, SV8,5-8

ZADNÍ SKUPINOVÉ SVÍTILNY / REAR LAMPS / HECKLEUCHTEN / ЗАДНИЕ ФОНАРИ

MULTIPOINT IV.

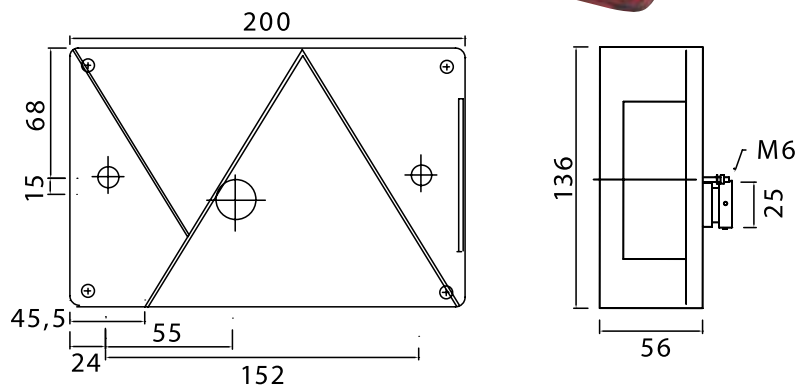

KÓD / ORDER CODE / BESTELL NR. / КОД	OE / OE NUMBER / OE NUMMER / OE	PRAVÁ / RIGHT / RECHTS / ПРАВЯЯ	LEVÁ / LEFT / LINKS / ЛЕВАЯ	OSVĚTLENÍ SPZ / ILLUMINATION FOR NUMBERPLATE / KENNZEICHENLEUCHTE / ПОДСВЕТКА НОМЕРНОГО ЗНАКА	ZPÁTEČKA / REVERSING LAMP / RÜCKFAHRLEUCHTE / ФОНАРЬ ЗАДНЕГО ХОДА	MLHOVKA / REAR FOG LAMP / NEBEL / ПРОТИВОТУМАННАЯ ФАРА
722017	24-8610-007	■		■	■	
722019	24-8400-007		■	■		■
722020 KRYT / LENS / LICHTSCHEIBE / Крышка	18-8486-007	■				
722022 KRYT / LENS / LICHTSCHEIBE / Крышка	18-8484-007		■			

Opravná sada / Repair Kit / Anschlussatz / Ремонтный комплект		Připojení / Connection / Anschluss / Соединение				
721761 PRAVÁ / RIGHT / RECHTS / Правая	13-0523-044			722931	12V	P21W 12V, BA15s
721760 LEVÁ / LEFT / LINKS / Левая	13-0521-044			722937	12V	P21 5W 12V, BAY15d
				722950	12V	C5W 12V, SV8,5-8
				722932	24V	P21W 24V, BA15s
				722938	24V	P21 5W 24V, BAY15d
				722951	24V	C5W 24V, SV8,5-8

Important notice: part of other producers are only mentioned for comparison purposes.

ZADNÍ SKUPINOVÉ SVÍTILNY / REAR LAMPS / HECKLEUCHTEN / ЗАДНИЕ ФОНАРИ

AGADOS

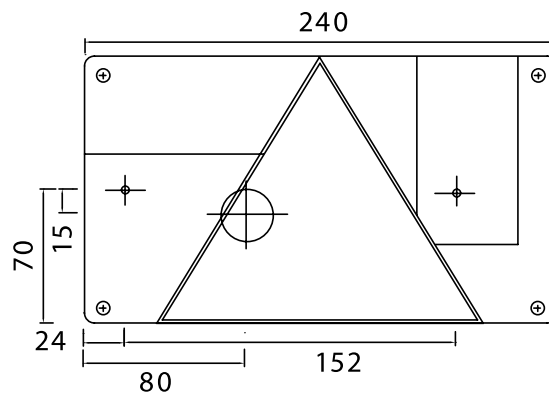

KÓD / ORDER CODE / BESTELL NR. / КОД	OE / OE NUMBER / OE NUMMER / OE	PRAVÁ / RIGHT / RECHTS / ПРАВАЯ	LEVÁ / LEFT / LINKS / ЛЕВАЯ	OSVĚTLENÍ SPZ / ILLUMINATION FOR NUMBERPLATE / KENNZEICHENLEUCHTE / ПОДСВЕТКА НОМЕРНОГО ЗНАКА	ZPÁTEČKA / REVERSING LAMP / RÜCKFAHRLEUCHTE / ФОНАРЬ ЗАДНЕГО ХОДА	MLHOVKA / REAR FOG LAMP / NEBEL. / ПРОТИВОТУМАННАЯ ФАРА
721223		■		■		
721225			■	■		■
721224 KRYT / LENS / LICHTSCHEIBE / Крышка		■		■		
721226 KRYT / LENS / LICHTSCHEIBE / Крышка			■	■		■

Opravná sada / Repair Kit / Anschlussatz / Ремонтный комплект		Připojení / Connection / Anschluss / Соединение				
721761 PRAVÁ / RIGHT / RECHTS / Правая	13-0523-044			722931	12V	P21W 12V, BA15s
				722937	12V	P21 5W 12V, BAY15d
721760 LEVÁ / LEFT / LINKS / Левая	13-0521-044			722950	12V	C5W 12V, SV8,5-8
				722932	24V	P21W 24V, BA15s
				722938	24V	P21 5W 24V, BAY15d
				722951	24V	C5W 24V, SV8,5-8

ZADNÍ SKUPINOVÉ SVÍTILNY / REAR LAMPS / HECKLEUCHTEN / ЗАДНИЕ ФОНАРИ

AGADOS II.

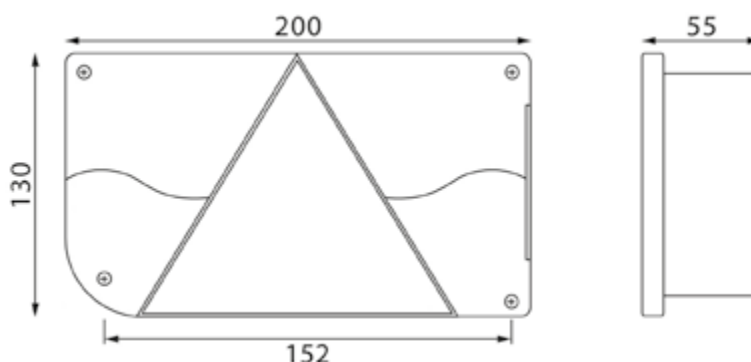

KÓD / ORDER CODE / BESTELL NR. / КОД	OE / OE NUMBER / OE NUMMER / OE	PRAVÁ / RIGHT / RECHTS / ПРАВАЯ	LEVÁ / LEFT / LINKS / ЛЕВАЯ	OSVĚTLENÍ SPZ / ILLUMINATION FOR NUMBERPLATE / KENNZEICHENLEUCHTE / ПОДСВЕТКА НОМЕРНОГО ЗНАКА	ZPÁTEČKA / REVERSING LAMP / RÜCKFAHRLEUCHTE / ФОНАРЬ ЗАДНЕГО ХОДА	MLHOVKA / REAR FOG LAMP / NEBEL. / ПРОТИВОТУМАННАЯ ФАРА
721262		■		■	■	
721263			■	■		■
721264 KRYT / LENS / LICHTSCHEIBE / Крышка		■		■	■	
721265 KRYT / LENS / LICHTSCHEIBE / Крышка			■	■		■

Opravná sada / Repair Kit / Anschlussatz / Ремонтный комплект		
721761 PRAVÁ / RIGHT / RECHTS / Правая	13-0523-044	
721760 LEVÁ / LEFT / LINKS / Левая	13-0521-044	

Připojení / Connection / Anschluss / Соединение

722931	12V	P21W 12V, BA15s
722937	12V	P21 5W 12V, BAY15d
722934	12V	PY21W 12V, BAU15s
722932	24V	P21W 24V, BA15s
722938	24V	P21 5W 24V, BAY15d
722935	24V	PY21W 24V, BAU15s

Important notice: part of other producers are only mentioned for comparison purposes.

ZADNÍ SKUPINOVÉ SVÍTLILNY / REAR LAMPS / HECKLEUCHTEN / ЗАДНИЕ ФОНАРИ



SVĚTLO KONCOVÉ, BRZDOVÉ, SMĚROVÉ, COUVACÍ / REAL LAMP, BRAKING, DIRECTIONAL, REVERSE /
LICHT ENDE, BREMSSEN, RICHTUNGS, RÜCKWÄRTS / ЛЕГКИЙ КОНЕЦ, ТОРМОЗА, НАПРАВЛЕННЫЙ, ОБРАТНАЯ

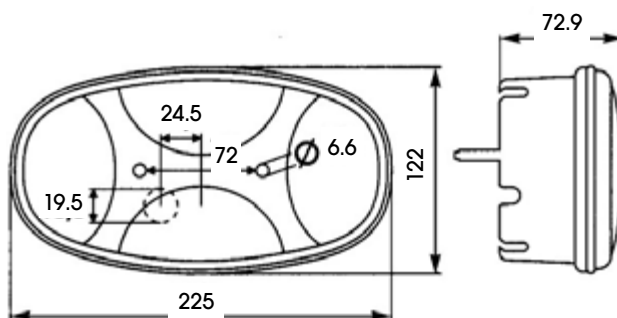

KÓD / ORDER CODE / BESTELL NR. / КОД	OE / OE NUMBER / OE NUMMER / OE	PRAVÁ / RIGHT / RECHTS / ПРАВАЯ	LEVÁ / LEFT / LINKS / ЛЕВАЯ	OSVĚTLENÍ SPZ / ILLUMINATION FOR NUMBERPLATE / KENNZEICHENLEUCHE / ПОДСВЕТКА НОМЕРНОГО ЗНАКА	PŘIPOJENÍ / CONNECTION / ANSCHLUSS / СОЕДИНЕНИЕ	
725077	2VP343640-021	■				
725078	2VP343640-031		■			
725081 - KRYT / LENS / LICHTSCHEIBE / КРЫШКА	9EL343142-001	■				
725082 - KRYT / LENS / LICHTSCHEIBE / КРЫШКА	9EL343143-001		■			
Průchodka / Grommet / Gummitülle / кренгельс				722931	12V	P21W 12V, BA15s
				722943	12V	R10W 12V, BA15s
				722932	24V	P21W 24V, BA15s
				722944	24V	R10W 24V, BA15s
724360						



SVĚTLO KONCOVÉ, BRZDOVÉ, SMĚROVÉ, COUVACÍ / REAL LAMP, BRAKING, DIRECTIONAL, REVERSE /
LICHT ENDE, BREMSSEN, RICHTUNGS, RÜCKWÄRTS / ЛЕГКИЙ КОНЕЦ, ТОРМОЗА, НАПРАВЛЕННЫЙ, ОБРАТНАЯ

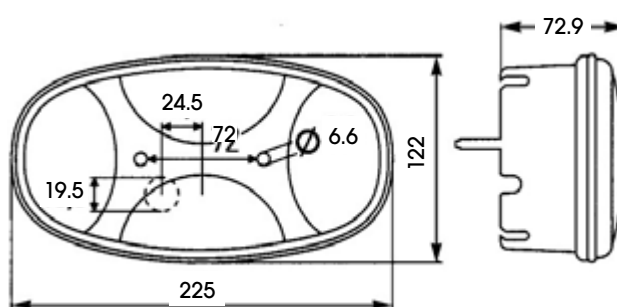



KÓD / ORDER CODE / BESTELL NR. / КОД	OE / OE NUMBER / OE NUMMER / OE	PRAVÁ / RIGHT / RECHTS / ПРАВАЯ	LEVÁ / LEFT / LINKS / ЛЕВАЯ	OSVĚTLENÍ SPZ / ILLUMINATION FOR NUMBERPLATE / KENNZEICHENLEUCHE / ПОДСВЕТКА НОМЕРНОГО ЗНАКА	PŘIPOJENÍ / CONNECTION / ANSCHLUSS / СОЕДИНЕНИЕ	
725079	2VP343640-041	■				
725080	2VP343640-051		■			
725081 - KRYT / LENS / LICHTSCHEIBE / КРЫШКА	9EL343142-001	■				
725082 - KRYT / LENS / LICHTSCHEIBE / КРЫШКА	9EL343143-001		■			
Opravná sada / Repair Kit / Anschlusssatz / Ремонтный комплект				722931	12V	P21W 12V, BA15s
				722943	12V	R10W 12V, BA15s
				722932	24V	P21W 24V, BA15s
				722944	24V	R10W 24V, BA15s
721069						

ZADNÍ SKUPINOVÉ SVÍTLILNY / REAR LAMPS / HECKLEUCHTEN / ЗАДНИЕ ФОНАРИ

SVĚTLO KONCOVÉ, BRZDOVÉ, SMĚROVÉ, COUVACÍ, MLHOVÉ / REAL LAMP, BRAKING, DIRECTIONAL, REVERSE, FOG/
LICHT ENDE, BREMSEN, RICHTUNGS, RÜCKWÄRTS, NEBEL / ЛЕГКИЙ КОНЕЦ, ТОРМОЗА, НАПРАВЛЕННЫЙ, ОБРАТНАЯ, ТУМАН



KÓD / ORDER CODE / BESTELL NR. / КОД	OE / OE NUMBER / OE NUMMER / OE	PRAVÁ / RIGHT / RECHTS / ПРАВАЯ	LEVÁ / LEFT / LINKS / ЛЕВАЯ	OSVĚTLENÍ SPZ / ILLUMINATION FOR NUMBERPLATE / KENNZEICHENLEUCHTE / ПОДСВЕТКА НОМЕРНОГО ЗНАКА	PŘIPOJENÍ / CONNECTION / ANSCHLUSS / СОЕДИНЕНИЕ	
720578	02.1374.0200	■				
720577	02.1373.0200		■			
Opravná sada / Repair Kit / Anschlusssatz / Ремонтный комплект				722931	12V	P21W 12V, BA15s
721493				722934	12V	PY21W 12V, BAU15s
				722940	12V	R5W 12V, BA15s
720019				723932	24V	P21W 24V, BA15s
				722935	24V	PY21W 24V, BAU15s
				722957	24V	R5W 24V, BA15s

Important notice: part of other producers are only mentioned for comparison purposes.

ZADNÍ SKUPINOVÉ SVÍTILNY / REAR LAMPS / HECKLEUCHTEN / ЗАДНИЕ ФОНАРИ

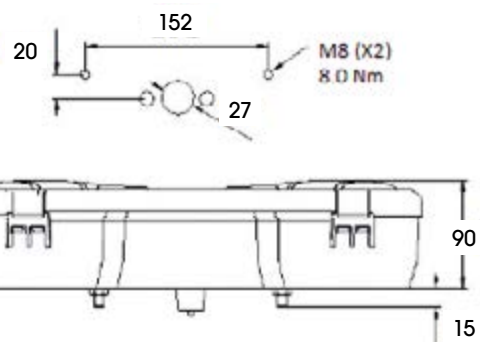
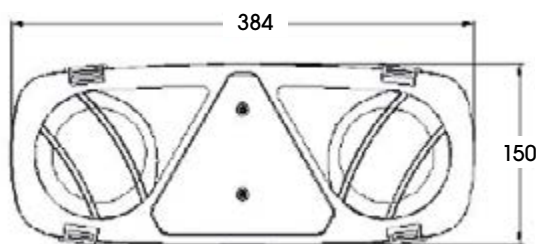

KÓD / ORDER CODE / BESTELL NR. / КОД	OE / OE NUMBER / OE NUMMER / OE	PRAVÁ / RIGHT / RECHTS / ПРАВАЯ	LEVÁ / LEFT / LINKS / ЛЕВАЯ	OSVĚTLENÍ SPZ / ILLUMINATION FOR NUMBERPLATE / KENNZEICHENLEUCHE / ПОДСВЕТКА НОМЕРНОГО ЗНАКА	PŘIPOJENÍ / CONNECTION / ANSCHLUSS / СОЕДИНЕНИЕ	
722883		■				
722884			■			
Opravná sada / Repair Kit / Anschlussatz / Ремонтный комплект				722931	12V	P21W 12V, BA15s
721493				722940	12V	R5W 12V, BA15s
				723932	24V	P21W 24V, BA15s
				722941	24V	R5W 24V, BA15s

ZADNÍ SKUPINOVÉ SVÍTILNY / REAR LAMPS / HECKLEUCHTEN / ЗАДНИЕ ФОНАРИ

MANITOU

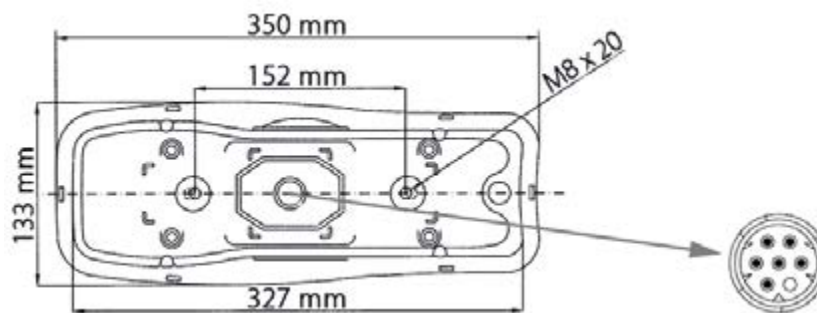

KÓD / ORDER CODE / BESTELL NR. / КОД	OE / OE NUMBER / OE NUMMER / OE	PRAVÁ / RIGHT / RECHTS / ПРАВАЯ	LEVÁ / LEFT / LINKS / ЛЕВАЯ	OSVĚTLENÍ SPZ / ILLUMINATION FOR NUMBERPLATE / KENNZEICHENLEUCHE / ПОДСВЕТКА НОМЕРНОГО ЗНАКА	PŘIPOJENÍ / CONNECTION / ANSCHLUSS / СОЕДИНЕНИЕ	
720382	152170	■				
720383	152180		■			
722679 KRYT / LENS / LICHTSCHEIBE / КРЫШКА	052500	■	■			
Opravná sada / Repair Kit / Anschlusssatz / Ремонтный комплект				722944	12V	R10W 24V, BA15s
				722932	24V	P21W 24V, BA15s
721493						

LAMBERET

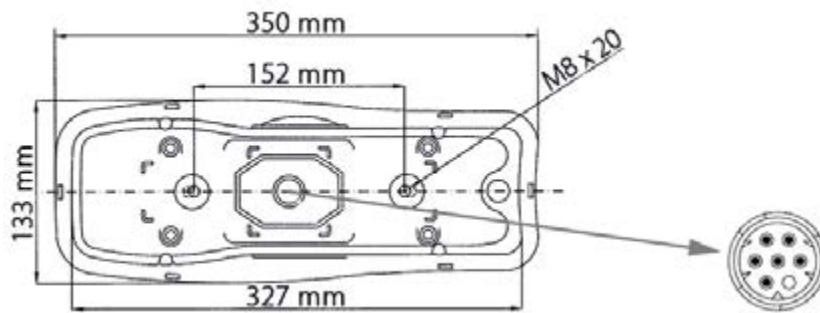

KÓD / ORDER CODE / BESTELL NR. / КОД	OE / OE NUMBER / OE NUMBER / OE	PRAVÁ / RIGHT / RECHTS / ПРАВАЯ	LEVÁ / LEFT / LINKS / ЛЕВАЯ	OSVĚTLENÍ SPZ / ILLUMINATION FOR NUMBERPLATE / KENNZEICHENLEUCHE / ПОДСВЕТКА НОМЕРНОГО ЗНАКА	PŘIPOJENÍ / CONNECTION / ANSCHLUSS / СОЕДИНЕНИЕ	
721568	153010	■				
721567	153000		■			
721569	153020		■	■		
721571 KRYT / LENS / LICHTSCHEIBE / КРЫШКА	053710	■				
721570 KRYT / LENS / LICHTSCHEIBE / КРЫШКА	053700		■			
Opravná sada / Repair Kit / Anschlusssatz / Ремонтный комплект				722941	24V	R5W 24V, BA15s
				722932	24V	P21W 24V, BA15s

721493



ZADNÍ SKUPINOVÉ SVÍTILNY / REAR LAMPS / HECKLEUCHTEN / ЗАДНИЕ ФОНАРИ

EASYCONN I.

PRŮHLLEDNÝ TROJÚHELNÍK / TRANSPARENT TRIANGLE / DREIECKRÜCKSTRAHLER / СВЕТООТРАЖАЮЩИЙ ТРЕУГОЛЬНИК

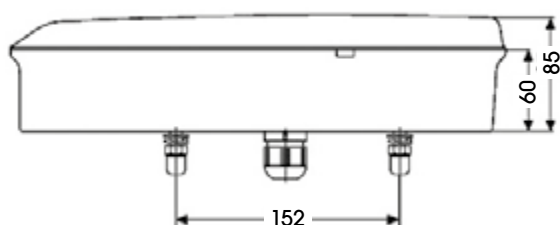
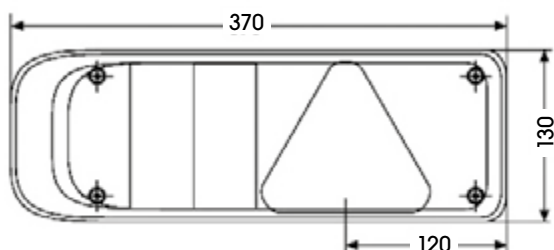

KÓD / ORDER CODE / BESTELL NR. / КОД	OE / OE NUMBER / OE NUMMER / OE	PRAVÁ / RIGHT / RECHTS / ПРАВАЯ	LEVÁ / LEFT / LINKS / ЛЕВАЯ	OSVĚTLENÍ SPZ / ILLUMINATION FOR NUMBERPLATE / KENNZEICHENLEUCHE / ПОДСВЕТКА НОМЕРНОГО ЗНАКА	PŘIPOJENÍ / CONNECTION / ANSCHLUSS / СОЕДИНЕНИЕ	
721166	2VP340931-001	■				
721167	2VP340931-011		■			
721164 KRYT / LENS / LICHTSCHEIBE / Крышка	9EL340829-021	■				
721165 KRYT / LENS / LICHTSCHEIBE / Крышка	9EL340829-031		■			
				722944	24V	R10W 24V, BA15s
				722932	24V	P21W 24V, BA15s

Important notice: part of other producers are only mentioned for comparison purposes.

ZADNÍ SKUPINOVÉ SVÍTILNY / REAR LAMPS / HECKLEUCHTEN / ЗАДНИЕ ФОНАРИ

EASYCONN I.

PRŮHLEDNÝ TROJÚHELNÍK / TRANSPARENT TRIANGLE / DREIECKRÜCKSTRAHLER / СВЕТООТРАЖАЮЩИЙ ТРЕУГОЛЬНИК

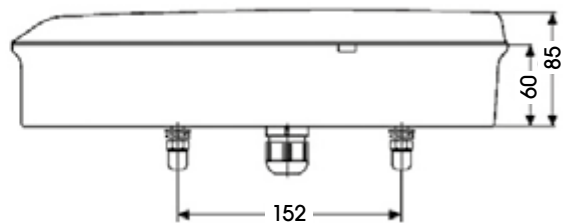
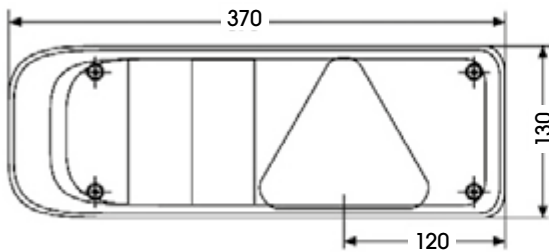

KÓD / ORDER CODE / BESTELL NR. / КОД	OE / OE NUMBER / OE NUMMER / OE	PRAVÁ / RIGHT / RECHTS / ПРАВАЯ	LEVÁ / LEFT / LINKS / ЛЕВАЯ	OSVĚTLENÍ SPZ / ILLUMINATION FOR NUMBERPLATE / KENNZEICHENLEUCHE / ПОДСВЕТКА НОМЕРНОГО ЗНАКА	PŘIPOJENÍ / CONNECTION / ANSCHLUSS / СОЕДИНЕНИЕ	
721160	2VP340930-021	■				
721161	2VP340930-031		■			
721164 KRYT / LENS / LICHTSCHEIBE / КРЫШКА	9EL340829-021	■				
721165 KRYT / LENS / LICHTSCHEIBE / КРЫШКА	9EL340829-031		■			
Opravná sada / Repair Kit / Anschlusssatz / Ремонтный комплект				722944	24V	R10W 24V, BA15s
				722932	24V	P21W 24V, BA15s
720511						

ZADNÍ SKUPINOVÉ SVÍTILNY / REAR LAMPS / HECKLEUCHTEN / ЗАДНИЕ ФОНАРИ

EASYCONN I.

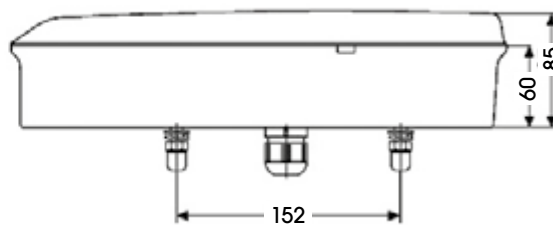
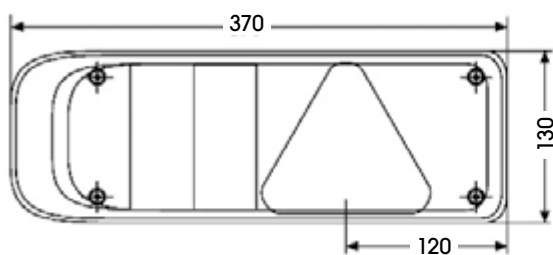

KÓD / ORDER CODE / BESTELL NR. / КОД	OE / OE NUMBER / OE NUMBER / OE	PRAVÁ / RIGHT / RECHTS / ПРАВАЯ	LEVÁ / LEFT / LINKS / ЛЕВАЯ	OSVĚTLENÍ SPZ / ILLUMINATION FOR NUMBERPLATE / KENNZEICHENLEUCHE / ПОДСВЕТКА НОМЕРНОГО ЗНАКА	PŘIPOJENÍ / CONNECTION / ANSCHLUSS / СОЕДИНЕНИЕ	
720514	2VP340830-021	■				
720515	2VP340830-031		■			
720516 KRYT / LENS / LICHTSCHEIBE / КРЫШКА	9EL340829-001	■				
720517 KRYT / LENS / LICHTSCHEIBE / КРЫШКА	9EL340829-011		■			
Opravná sada / Repair Kit / Anschlusssatz / Ремонтный комплект				722944	24V	R10W 24V, BA15s
				722932	24V	P21W 24V, BA15s
720511						

Important notice: part of other producers are only mentioned for comparison purposes.

ZADNÍ SKUPINOVÉ SVÍTLILNY / REAR LAMPS / HECKLEUCHTEN / ЗАДНИЕ ФОНАРИ

EUROPOINT I.

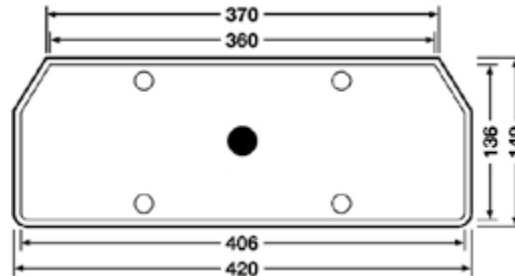

KÓD / ORDER CODE / BESTELL NR. / КОД	OE / OE NUMBER / OE NUMMER / OE	PRAVÁ / RIGHT / RECHTS / ПРАВАЯ	LEVÁ / LEFT / LINKS / ЛЕВАЯ	OSVĚTLENÍ SPZ / ILLUMINATION FOR NUMBERPLATE / KENNZEICHENLEUCHTE / ПОДСВЕТКА НОМЕРНОГО ЗНАКА	PŘIPOJENÍ / CONNECTION / ANSCHLUSS / СОЕДИНЕНИЕ	
722632	25-5500-507	■				
722623	25-5100-507		■			
722636 KRYT / LENS / LICHTSCHEIBE / КРЫШКА	18-8550-002	■	■			
				722932	24V	P21W 24V, BA15s
				722938	24V	P21 5W 24V, BAY15d
				723941	24V	R5W 24V, BA15s

EUROPOINT I.

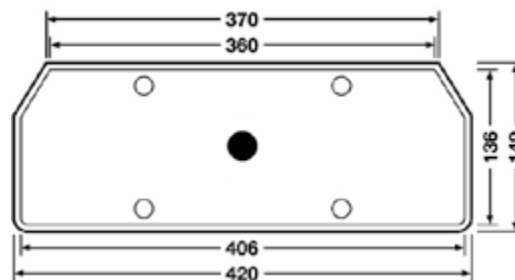

KÓD / ORDER CODE / BESTELL NR. / КОД	OE / OE NUMBER / OE NUMMER / OE	PRAVÁ / RIGHT / RECHTS / ПРАВАЯ	LEVÁ / LEFT / LINKS / ЛЕВАЯ	OSVĚTLENÍ SPZ / ILLUMINATION FOR NUMBERPLATE / KENNZEICHENLEUCHTE / ПОДСВЕТКА НОМЕРНОГО ЗНАКА	PŘIPOJENÍ / CONNECTION / ANSCHLUSS / СОЕДИНЕНИЕ	
722607	25-5400-507	■				
722615	25-5000-507		■			
722636 KRYT / LENS / LICHTSCHEIBE / КРЫШКА	18-8550-002	■	■			
Opravná sada / Repair Kit / Anschlusssatz / Ремонтный комплект				722932	24V	P21W 24V, BA15s
				722938	24V	P21 5W 24V, BAY15d
				723941	24V	R5W 24V, BA15s

EUROPOINT II.

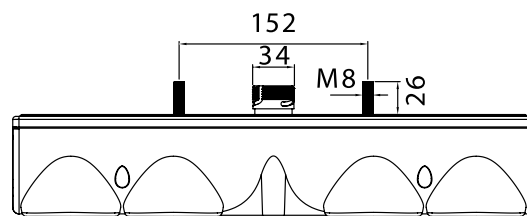
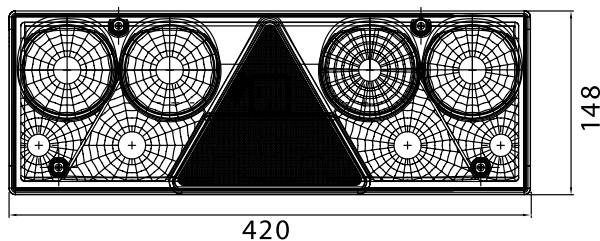



KÓD / ORDER CODE / BESTELL NR. / КОД	OE / OE NUMBER / OE NUMMER / OE	PRAVÁ / RIGHT / RECHTS / ПРАВАЯ	LEVÁ / LEFT / LINKS / ЛЕВАЯ	OSVĚTLENÍ SPZ / ILLUMINATION FOR NUMBERPLATE / KENNZEICHENLEUCHTE / ПОДСВЕТКА НОМЕРНОГО ЗНАКА	PŘIPOJENÍ / CONNECTION / ANSCHLUSS / СОЕДИНЕНИЕ	
722609	25-6400-507	■				
722608	25-6000-507		■			
722610 KRYT / LENS / LICHTSCHEIBE / КРЫШКА	18-8560-002	■	■			
Opravná sada / Repair Kit / Anschlusssatz / Ремонтный комплект				722932	24V	P21W 24V, BA15s
725506	13-5626-951			722944	24V	R10W 24V, BA15s
				722935	24V	PY21W 24V, BAU15s

ZADNÍ SKUPINOVÉ SVÍTILNY / REAR LAMPS / HECKLEUCHTEN / ЗАДНИЕ ФОНАРИ

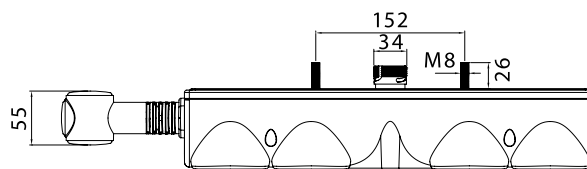
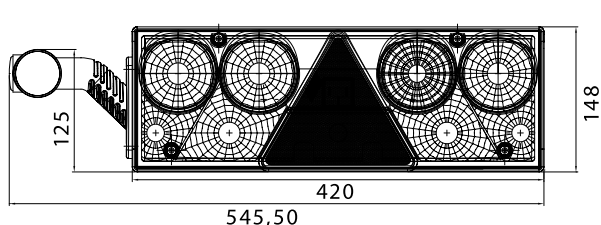
EUROPOINT II.

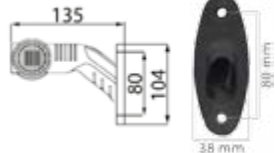

KÓD / ORDER CODE / BESTELL NR. / КОД	OE / OE NUMBER / OE NUMBER / OE	PRAVÁ / RIGHT / RECHTS / ПРАВАЯ	LEVÁ / LEFT / LINKS / ЛЕВАЯ	OSVĚTLENÍ SPZ / ILLUMINATION FOR NUMBERPLATE / KENNZEICHENLEUCHTE / ПОДСВЕТКА НОМЕРНОГО ЗНАКА	PŘIPOJENÍ / CONNECTION / ANSCHLUSS / СОЕДИНЕНИЕ
722602	25-6411-517	■			
722604	25-6011-517		■		
722610 KRYT / LENS / LICHTSCHEIBE / КРЫШКА	18-8560-002	■	■		

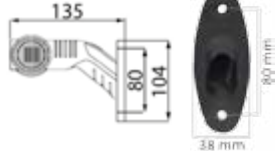
KÓD / ORDER CODE / BESTELL NR. / КОД		POPIS / DESCRIPTION / BESCHREIBUNG / ОПИСАНИЕ	OE / OE NUMBER / OE NUMBER / OE	NÁKRES / DRAWING / ZEICHNUNG / ЧЕРТЁЖ
725520 PRAVÁ / RIGHT / RECHTS / Правая		<ul style="list-style-type: none"> ■ ČERVENÁ + BÍLÁ + ORANŽOVÁ, KABEL - 0,1 m ■ RED + WHITE + ORANGE, CABLE - 0,1 m ■ ROT + WEISS + ORANGE, KABEL - 0,1 m ■ Красная + Белая + Оранжевая, Кабель - 0,1 м 	31-3306-067	
725521 LEVÁ / LEFT / LINKS / Левая		<ul style="list-style-type: none"> ■ ČERVENÁ + BÍLÁ + ORANŽOVÁ, KABEL - 0,1 m ■ RED + WHITE + ORANGE, CABLE - 0,1 m ■ ROT + WEISS + ORANGE, KABEL - 0,1 m ■ Красная + Белая + Оранжевая, Кабель - 0,1 м 	31-3305-067	
				722948 / 12 V / T4W 12V, BA9s 722949 / 24 V / T4W 24V, BA9s

Opravná sada / Repair Kit / Anschlussatz / Ремонтный комплект

725506

13-5626-951



722932

24V

P21W 24V, BA15s

722944

24V

R10W 24V, BA15s

722935

24V

PY21W 24V, BAU15s

722949

24V

T4W 24V, BA9s

ZADNÍ SKUPINOVÉ SVÍTILNY / REAR LAMPS / HECKLEUCHTEN / ЗАДНИЕ ФОНАРИ

EUROPOINT III.

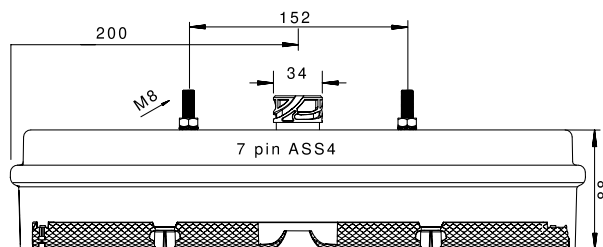
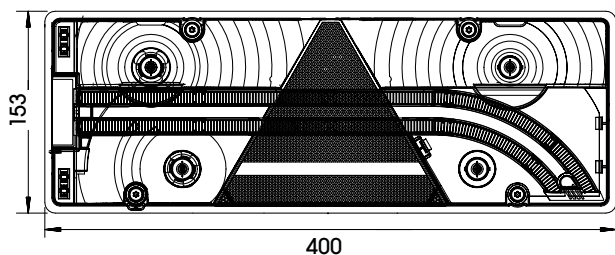

KÓD / ORDER CODE / BESTELL NR. / КОД	OE / OE NUMBER / OE NUMBER / OE	PRÁVÁ / RIGHT / RECHTS / ПРАВАЯ	LEVÁ / LEFT / LINKS / ЛЕВАЯ	OSVĚTLENÍ SPZ / ILLUMINATION FOR NUMBERPLATE / KENNZEICHENLEUCHE / ПОДСВЕТКА НОМЕРНОГО ЗНАКА	PŘIPOJENÍ / CONNECTION / ANSCHLUSS / СОЕДИНЕНИЕ
722616	25-7400-507	■			
722617	25-7000-507		■		
722621 KRYT / LENS / LICHTSCHEIBE / Крышка	18-8570-101	■			
722622 KRYT / LENS / LICHTSCHEIBE / Крышка	18-8570-001		■		
722627 TRUBICE / INSERT „LIGHT GUIDE“ R / EINSATZ „LIGHT GUIDE“ R / СВЕТОДИОДНАЯ ТРУБКА ОСВЕЩЕНИЯ В ФАРАХ ПРАВАЯ	12-1570-101	■			
722628 TRUBICE / INSERT „LIGHT GUIDE“ L / EINSATZ „LIGHT GUIDE“ L / СВЕТОДИОДНАЯ ТРУБКА ОСВЕЩЕНИЯ В ФАРАХ ЛЕВАЯ	12-1570-001		■		
Opravná sada / Repair Kit / Anschlussatz / Ремонтный комплект					
722932				24V	P21W 24V, BA15s
722944				24V	R10W 24V, BA15s
725506	13-5626-951				

Important notice: part of other producers are only mentioned for comparison purposes.

ZADNÍ SKUPINOVÉ SVÍTILNY / REAR LAMPS / HECKLEUCHTEN / ЗАДНИЕ ФОНАРИ

EUROPOINT I.

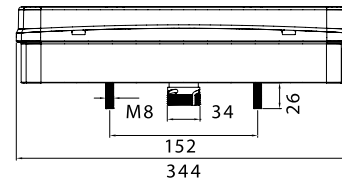
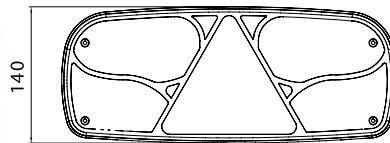

KÓD / ORDER CODE / BESTELL NR. / КОД	OE / OE NUMBER / OE NUMMER / OE	PRAVÁ / RIGHT / RECHTS / ПРАВАЯ	LEVÁ / LEFT / LINKS / ЛЕВАЯ	OSVĚTLENÍ SPZ / ILLUMINATION FOR NUMBERPLATE / KENNZEICHENLEUCHE / ПОДСВЕТКА НОМЕРНОГО ЗНАКА	PŘIPOJENÍ / CONNECTION / ANSCHLUSS / СОЕДИНЕНИЕ	
724832	25-2600-007	■				
724833	25-2200-007		■			
724840 KRYT / LENS / LICHTSCHEIBE / СКРЫШКА	18-8522-002	■	■			
Opravná sada / Repair Kit / Anschlusssatz / Ремонтный комплект				722932	24V	P21W 24V, BA15s
725506	13-5626-951			722938	24V	P21 5W 24V, BAY15d

EUROPOINT I.

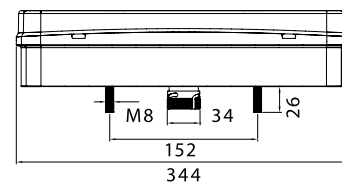
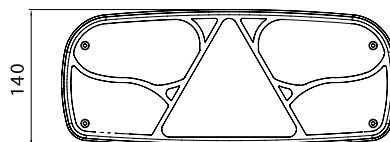

KÓD / ORDER CODE / BESTELL NR. / КОД	OE / OE NUMBER / OE NUMMER / OE	PRAVÁ / RIGHT / RECHTS / ПРАВАЯ	LEVÁ / LEFT / LINKS / ЛЕВАЯ	OSVĚTLENÍ SPZ / ILLUMINATION FOR NUMBERPLATE / KENNZEICHENLEUCHE / ПОДСВЕТКА НОМЕРНОГО ЗНАКА	PŘIPOJENÍ / CONNECTION / ANSCHLUSS / СОЕДИНЕНИЕ	
724823	25-2400-507	■				
724831	25-2000-507		■			
724842 KRYT / LENS / LICHTSCHEIBE / КРЫШКА	18-8520-002	■	■			
Opravná sada / Repair Kit / Anschlusssatz / Ремонтный комплект				722932	24V	P21W 24V, BA15s
725506	13-5626-951			722941	24V	R5W 24V, BA15s

ECOPOINT I.

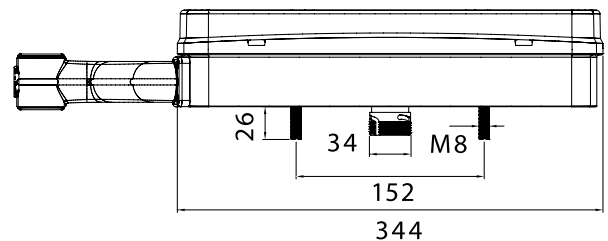
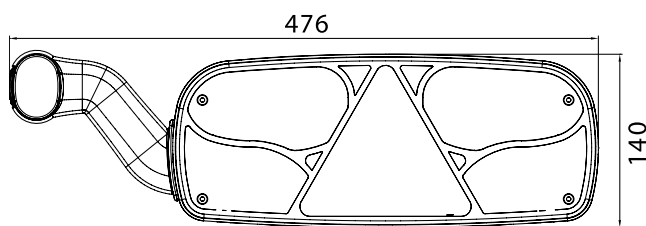

KÓD / ORDER CODE / BESTELL NR. / КОД	OE / OE NUMBER / OE NUMMER / OE	PRAVÁ / RIGHT / RECHTS / ПРАВАЯ	LEVÁ / LEFT / LINKS / ЛЕВАЯ	OSVĚTLENÍ SPZ / ILLUMINATION FOR NUMBERPLATE / KENNZEICHENLEUCHTE / ПОДСВЕТКА НОМЕРНОГО ЗНАКА	PŘIPOJENÍ / CONNECTION / ANSCHLUSS / СОЕДИНЕНИЕ
724836	25-2610-007	■			
724835	25-2210-007		■		
724840 KRYT / LENS / LICHTSCHEIBE / Крышка	18-8522-002	■	■		

Opravná sada / Repair Kit / Anschlussatz / Ремонтный комплект		
725506	13-5626-951	

722932	24V	P21W 24V, BA15s
722938	24V	P21 5W 24V, BAY15d
722949	24V	T4W 24V, BA9s

ECOPOINT I.

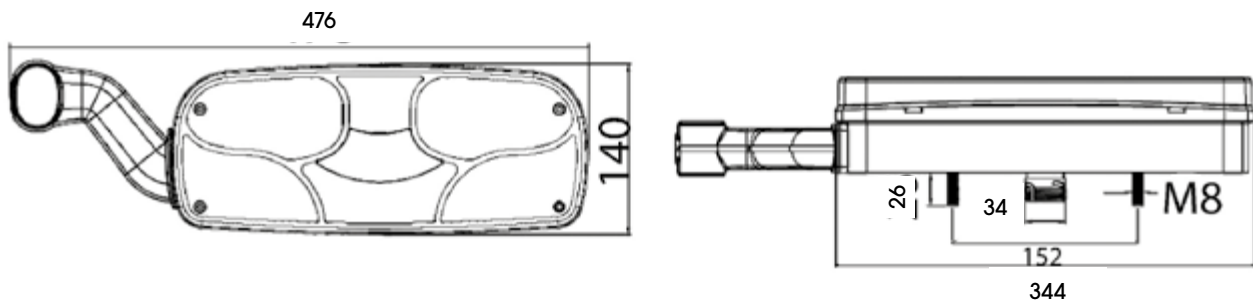

KÓD / ORDER CODE / BESTELL NR. / КОД	OE / OE NUMBER / OE NUMMER / OE	PRAVÁ / RIGHT / RECHTS / ПРАВАЯ	LEVÁ / LEFT / LINKS / ЛЕВАЯ	OSVĚTLENÍ SPZ / ILLUMINATION FOR NUMBERPLATE / KENNZEICHENLEUCHE / ПОДСВЕТКА НОМЕРНОГО ЗНАКА	PŘIPOJENÍ / CONNECTION / ANSCHLUSS / СОЕДИНЕНИЕ	
724846	25-2410-507	■				
724847	25-2010-507		■			
724842 KRYT / LENS / LICHTSCHEIBE / Крышка	18-8520-002	■	■			
Opravná sada / Repair Kit / Anschlussatz / Ремонтный комплект				722932	24V	P21W 24V, BA15s
				722941	24V	R5W 24V, BA15s
				722949	24V	T4W 24V, BA9s
725506	13-5626-951					

ZADNÍ SKUPINOVÉ SVÍTILNY / REAR LAMPS / HECKLEUCHTEN / ЗАДНИЕ ФОНАРИ

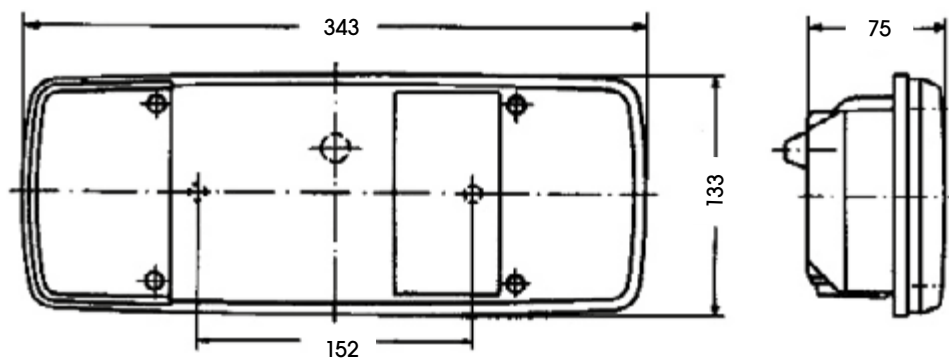

KÓD / ORDER CODE / BESTELL NR. / КОД	OE / OE NUMBER / OE NUMMER / OE	PRAVÁ / RIGHT / RECHTS / ПРАВАЯ	LEVÁ / LEFT / LINKS / ЛЕВАЯ	OSVĚTLENÍ SPZ / ILLUMINATION FOR NUMBERPLATE / KENNZEICHENLEUCHTE / ПОДСВЕТКА НОМЕРНОГО ЗНАКА	PŘIPOJENÍ / CONNECTION / ANSCHLUSS / СОЕДИНЕНИЕ	
720247	2VP003567-121	■				
720248	2VP003567-111		■	■		
720249 KRYT / LENS / LICHTSCHEIBE / КРЫШКА	9EL122689-021	■	■			
				722932	24V	P21W 24V, BA15s
				722944	24V	R10W 24V, BA15s

Important notice: part of other producers are only mentioned for comparison purposes.

ZADNÍ SKUPINOVÉ SVÍTLILNY / REAR LAMPS / HECKLEUCHTEN / ЗАДНИЕ ФОНАРИ

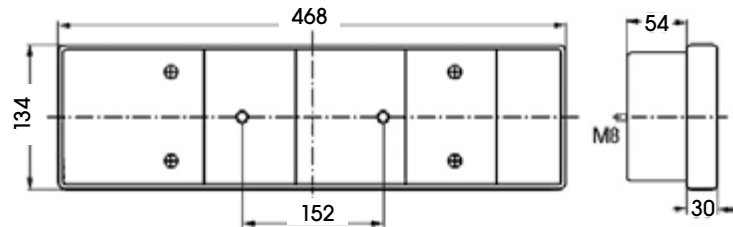

KÓD / ORDER CODE / BESTELL NR. / КОД	OE / OE NUMBER / OE NUMMER / OE	PRAVÁ / RIGHT / RECHTS / ПРАВАЯ	LEVÁ / LEFT / LINKS / ЛЕВАЯ	OSVĚTLENÍ SPZ / ILLUMINATION FOR NUMBERPLATE / KENNZEICHENLEUCHTE / ПОДСВЕТКА НОМЕРНОГО ЗНАКА	PŘIPOJENÍ / CONNECTION / ANSCHLUSS / СОЕДИНЕНИЕ	
720251		■				
720252			■			
722716 KRYT / LENS / LICHTSCHEIBE / КРЫШКА		■				
722718 KRYT / LENS / LICHTSCHEIBE / КРЫШКА			■			
				722932	24V	P21W 24V, BA15s
				722944	24V	R10W 24V, BA15s

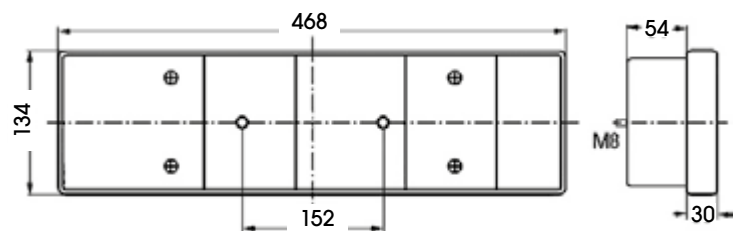

KÓD / ORDER CODE / BESTELL NR. / КОД	OE / OE NUMBER / OE NUMMER / OE	PRAVÁ / RIGHT / RECHTS / ПРАВАЯ	LEVÁ / LEFT / LINKS / ЛЕВАЯ	OSVĚTLENÍ SPZ / ILLUMINATION FOR NUMBERPLATE / KENNZEICHENLEUCHTE / ПОДСВЕТКА НОМЕРНОГО ЗНАКА	PŘIPOJENÍ / CONNECTION / ANSCHLUSS / СОЕДИНЕНИЕ	
722060		■				
722061			■	■		
722063 KRYT / LENS / LICHTSCHEIBE / КРЫШКА	9EL152889-001	■	■			
				722932	24V	P21W 24V, BA15s
				722944	24V	R10W 24V, BA15s

ZADNÍ SKUPINOVÉ SVÍTILNY / REAR LAMPS / HECKLEUCHTEN / ЗАДНИЕ ФОНАРИ

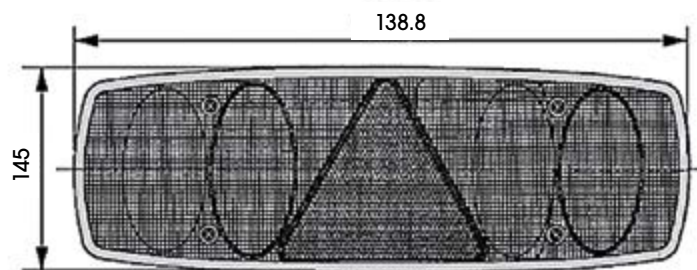

KÓD / ORDER CODE / BESTELL NR. / КОД	OE / OE NUMBER / OE NUMMER / OE	PRÁVÁ / RIGHT / RECHTS / ПРАВАЯ	LEVÁ / LEFT / LINKS / ЛЕВАЯ	OSVĚTLENÍ SPZ / ILLUMINATION FOR NUMBERPLATE / KENNZEICHENLEUCHE / ПОДСВЕТКА НОМЕРНОГО ЗНАКА	PŘIPOJENÍ / CONNECTION / ANSCHLUSS / СОЕДИНЕНИЕ	
722066		■				
722065			■			
722067 KRYT / LENS / LICHTSCHEIBE / КРЫШКА		■				
722068 KRYT / LENS / LICHTSCHEIBE / КРЫШКА			■			
Opravná sada / Repair Kit / Anschlusssatz / Ремонтный комплект				722932	24V	P21W 24V, BA15s
				722938	24V	P21 5W 24V, BAY15d
				722941	24V	R5W 24V, BA15s
721493						

Important notice: part of other producers are only mentioned for comparison purposes.

ZADNÍ SKUPINOVÉ SVÍTILNY / REAR LAMPS / HECKLEUCHTEN / ЗАДНИЕ ФОНАРИ

ZADNÍ SMĚROVÁ SVÍTILNA / REAR INDICATOR /HECKL. BLINKL. / ЗАДНИЙ ИНДИКАТОР

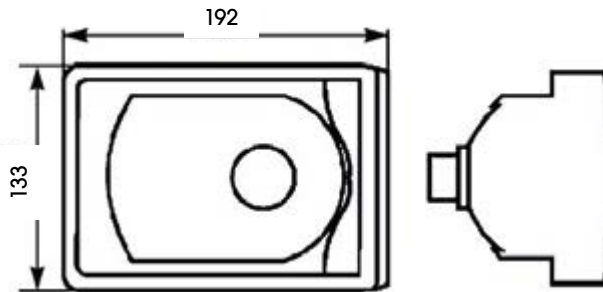

KÓD / ORDER CODE / BESTELL NR. / КОД	OE / OE NUMBER / OE NUMMER / OE	PRAVÁ / RIGHT / RECHTS / ПРАВАЯ	LEVÁ / LEFT / LINKS / ЛЕВАЯ	OSVĚTLENÍ SPZ / ILLUMINATION FOR NUMBERPLATE / KENNZEICHENLEUCHE / ПОДСВЕТКА НОМЕРНОГО ЗНАКА	PŘIPOJENÍ / CONNECTION / ANSCHLUSS / СОЕДИНЕНИЕ	
727006/N	99008805057 2BA008805-051	■	■			
				722934	12V	PY21W 12V, BAU15s
				722935	24V	PY21W 24V, BAU15s

ZADNÍ KONCOVÁ, BRZDOVÁ SVÍTILNA / RÜCKLICHT, BREMSLICHT / TAILLIGHT, BRAKE LIGHT / ЗАДНИЙ ФОНАРЬ, ДОПОЛНИТЕЛЬНЫЙ СТОП-СИГНАЛ

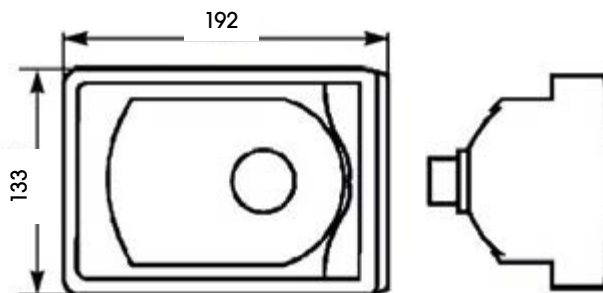

KÓD / ORDER CODE / BESTELL NR. / КОД	OE / OE NUMBER / OE NUMMER / OE	PRAVÁ / RIGHT / RECHTS / ПРАВАЯ	LEVÁ / LEFT / LINKS / ЛЕВАЯ	OSVĚTLENÍ SPZ / ILLUMINATION FOR NUMBERPLATE / KENNZEICHENLEUCHE / ПОДСВЕТКА НОМЕРНОГО ЗНАКА	PŘIPOJENÍ / CONNECTION / ANSCHLUSS / СОЕДИНЕНИЕ	
726999/N	2SB008805-021	■	■			
				722937	12V	P21 5W 12V, BAY15d
				722938	24V	P21 5W 24V, BAY15d

ZADNÍ SKUPINOVÉ SVÍTLILNY / REAR LAMPS / HECKLEUCHTEN / ЗАДНИЕ ФОНАРИ

ZPÁTEČKA / REVERSING LAMP / RÜCKFAHRLEUCHTE / ФОНАРЬ ЗАДНЕГО ХОДА

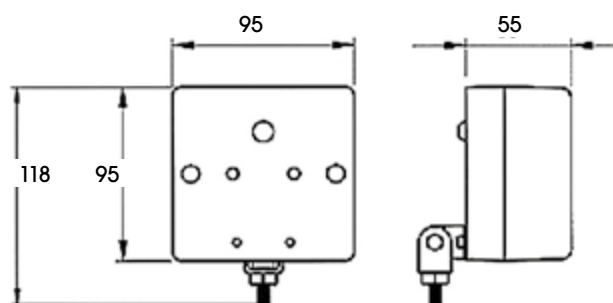

KÓD / ORDER CODE / BESTELL NR. / КОД	OE / OE NUMBER / OE NUMMER / OE	PRAVÁ / RIGHT / RECHTS / ПРАВАЯ	LEVÁ / LEFT / LINKS / ЛЕВАЯ	OSVĚTLENÍ SPZ / ILLUMINATION FOR NUMBERPLATE / KENNZEICHENLEUCHTE / ПОДСВЕТКА НОМЕРНОГО ЗНАКА	PŘIPOJENÍ / CONNECTION / ANSCHLUSS / СОЕДИНЕНИЕ
721730		■	■		
				722931	12V P21W 12V, BA15s
				722932	24V P21W 24V, BA15s

MLHOVKA / REAR FOG LAMP / NEBELSCHLUSSLEUCHTE / ПРОТИВОТУМАННАЯ ФАРА

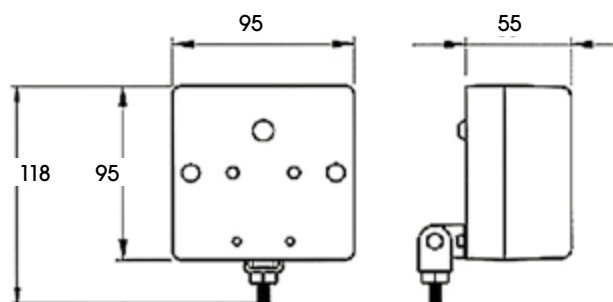





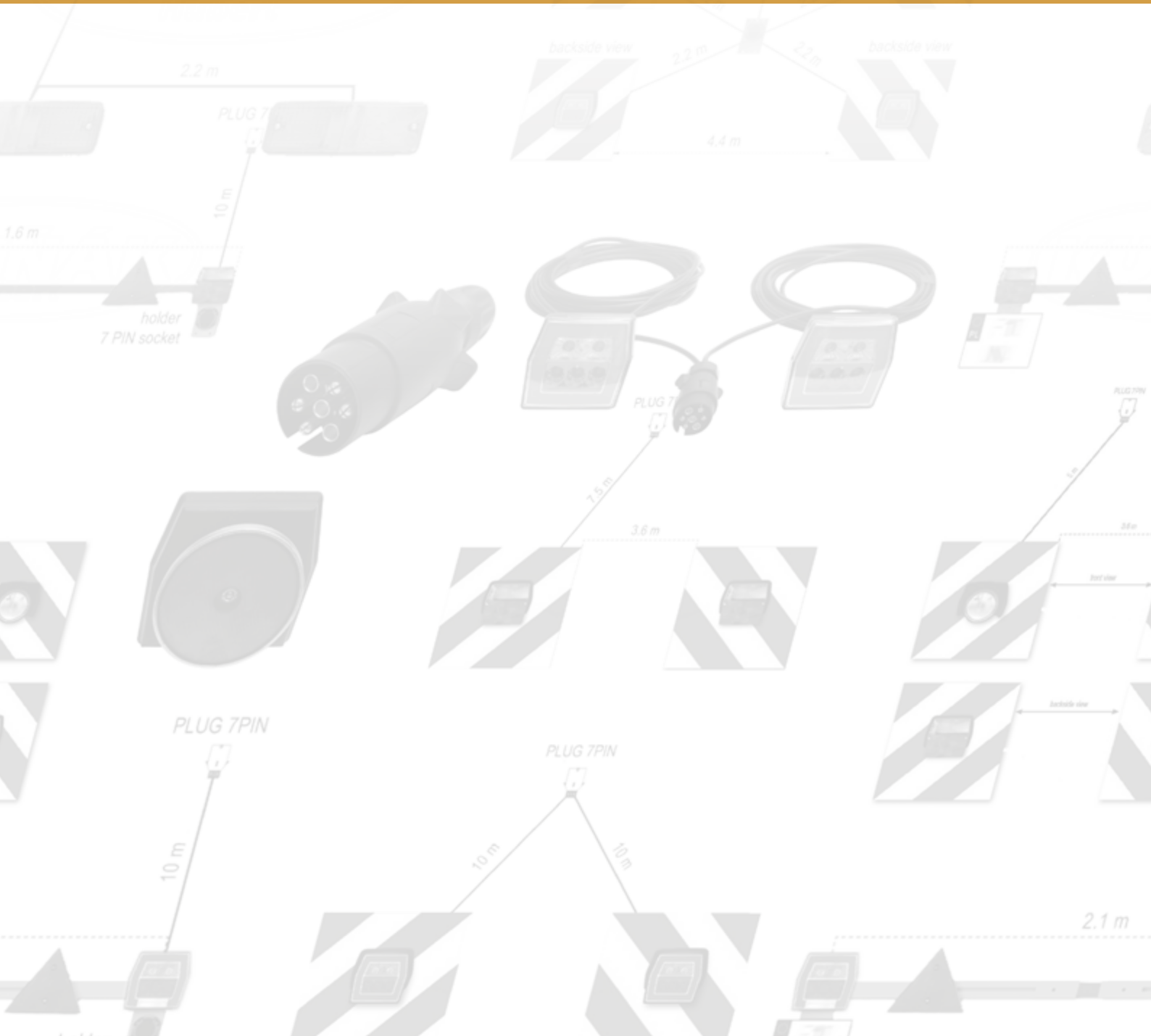

KÓD / ORDER CODE / BESTELL NR. / КОД	OE / OE NUMBER / OE NUMMER / OE	PRAVÁ / RIGHT / RECHTS / ПРАВАЯ	LEVÁ / LEFT / LINKS / ЛЕВАЯ	OSVĚTLENÍ SPZ / ILLUMINATION FOR NUMBERPLATE / KENNZEICHENLEUCHTE / ПОДСВЕТКА НОМЕРНОГО ЗНАКА	PŘIPOJENÍ / CONNECTION / ANSCHLUSS / СОЕДИНЕНИЕ
721726		■	■		
				722931	12V P21W 12V, BA15s
				722932	24V P21W 24V, BA15s

**SADA ZADNÍCH SKUPINOVÝCH SVÍTILEN /
SET REAR LAMP /
SET HECKLEUCHTE /
KIT - ЗАДНИЕ ФОНАРИ**



SADA ZADNÍCH SKUPINOVÝCH SVÍTILEN / SET REAR LAMP / SET HECKLEUCHTE / KIT - ЗАДНИЕ ФОНАРИ

KÓD / ORDER CODE / BESTELL NR. / КОД		POPIS / DESCRIPTION/ BESCHREIBUNG / ОПИСАНИЕ
724597		<p>12-24 V </p> <ul style="list-style-type: none"> ■ Sada dvou LED svítilen, které jsou instalovány pomocí šroubů. Souprava je spojena dvěma vodiči - délka 7 m, zakončené 7 pinovým konektorem ■ The set of two LED lamps to be installed with screws. The set is connected with two wires - 7 m length, tipped with 7PIN plug ■ Der Satz der zwei LED Lampen, die mit Schrauben angebracht werden. Das Set ist mit zwei Drähten - 7 m Länge, mit 7 PIN-Stecker ■ Набор из двух ламп для установки с помощью винтов. Набор связан с двумя проводами - 7 м длиной, прекращен 7 PIN штепсельной вилки
724598		<p>12-24 V  </p> <ul style="list-style-type: none"> ■ Sada dvou LED svítilen, které jsou uchyceny na magnet. Souprava je spojena dvěma vodiči - délka 7 m, zakončené 7 pinovým konektorem ■ The set of two lamps to be installed with magnet. The set is connected with two wires - 7 m length, tipped with 7PIN plug ■ Der Satz von zwei Lampen, die mit Magnet angebracht werden. Das Set ist mit zwei Drähten - 7 m Länge, mit 7 PIN-Stecker ■ Набор из двух ламп для установки с магнитом. Набор связан с двумя проводами - 7 м длиной, прекращен 7 PIN штепсельной вилки

Zástrčka / Plug / Stecker / Штекер		
720538		



SADA ZADNÍCH SKUPINOVÝCH SVÍTELN / SET REAR LAMP / SET HECKLEUCHTE / KIT - ЗАДНИЕ ФОНАРИ

KÓD / ORDER CODE / BESTELL NR. / КОД	POPIS / DESCRIPTION/ BESCHREIBUNG / ОПИСАНИЕ						
724599	<ul style="list-style-type: none"> ■ Osvětlovací soustava s lampami a osvětlením poznávací značky, vyrobené s velmi odolného skla, 7 PIN elektrická kabeláž o délce - 7,5 m, šířka - 2,2 m, žárovky součástí ■ Lighting set with lamps and license plate light, made with highly resistant glass, 7 PIN electric wiring in length - 7,5 m, width - 2,2 m, including bulbs ■ Beleuchtungssystem mit Leuchten und Kennzeichenleuchte aus hoch beständigem Glas, 7 PIN elektrische Verkabelung in der Länge - 7,5 m, Breite - 2,2 m, inklusive Glühlampen ■ Система освещения с лампами и подсветкой номерного знака, изготовленных из высокоустойчивого стекла, 7 контактной электропроводкой длиной - 7,5 м. ширина - 2,2 м., лампочки в том.числе. 						
	<table border="1"> <tr> <td>722931</td> <td>12V</td> <td>P21W 12V, BA15s</td> </tr> <tr> <td>722950</td> <td>12V</td> <td>C5W 12V, SV8,5-8</td> </tr> </table>	722931	12V	P21W 12V, BA15s	722950	12V	C5W 12V, SV8,5-8
722931	12V	P21W 12V, BA15s					
722950	12V	C5W 12V, SV8,5-8					

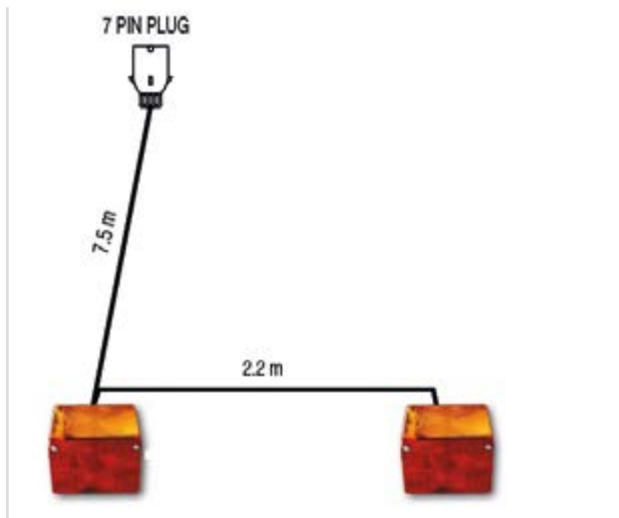

Lampa / Lamp / Lampe / Лампа	Kryt / Lens / Lichtscheibe / Крышка	Zástrčka / Plug / Stecker / Штекер
724620 Pravá / Right / Rechts / правая	724622	720538
724621 Levá / Left / Links / Левая		

KÓD / ORDER CODE / BESTELL NR. / КОД	POPIS / DESCRIPTION/ BESCHREIBUNG / ОПИСАНИЕ						
724600	<ul style="list-style-type: none"> ■ Osvětlovací soustava s lampami a osvětlením poznávací značky, 7 PIN elektrická kabeláž o délce - 7,5 m, šířka - 2,2 m, žárovky součástí ■ Lighting set with lamps and license plate light, 7 PIN electric wiring in length - 7,5 m, width - 2,2 m, including bulbs ■ Beleuchtungssystem mit Leuchten und Kennzeichenleuchte, 7 PIN elektrische Verkabelung in der Länge - 7,5 m, Breite - 2,2 m, inklusive Glühlampen ■ Система освещения с лампами и подсветкой номерного знака, 7 контактной электропроводкой длиной - 7,5 м, ширина - 2,2 м., лампочки в том.числе. 						
	<table border="1"> <tr> <td>722931</td> <td>12V</td> <td>P21W 12V, BA15s</td> </tr> <tr> <td>722937</td> <td>12V</td> <td>P21 5W 12V, BAY15d</td> </tr> </table>	722931	12V	P21W 12V, BA15s	722937	12V	P21 5W 12V, BAY15d
722931	12V	P21W 12V, BA15s					
722937	12V	P21 5W 12V, BAY15d					

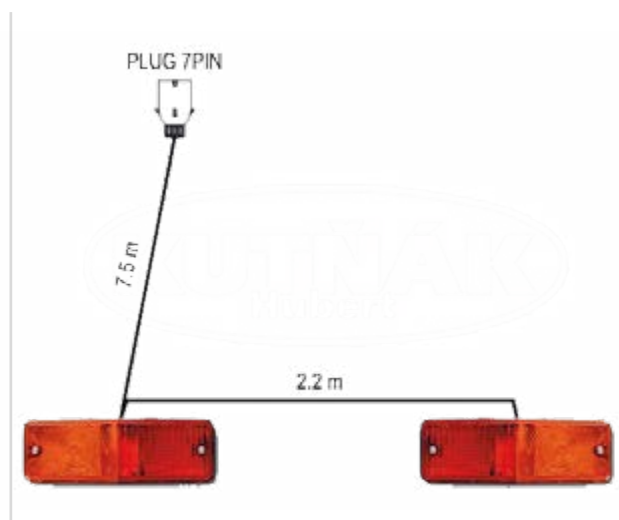

Lampa / Lamp / Lampe / Лампа	Kryt / Lens / Lichtscheibe / Крышка	Zástrčka / Plug / Stecker / Штекер
722260	722261	720538

SADA ZADNÍCH SKUPINOVÝCH SVÍTELN / SET REAR LAMP / SET HECKLEUCHTE / KIT - ЗАДНИЕ ФОНАРИ

KÓD / ORDER CODE / BESTELL NR. / КОД	POPIS / DESCRIPTION/ BESCHREIBUNG / ОПИСАНИЕ						
724601	<ul style="list-style-type: none"> ■ Osvětlovací soustava, 7PIN elektrická kabeláž o délce - 10 m, šířka - 1,6 m. Lamps vyrobené z velmi odolného skla, reflexní trojúhelník, 7PIN zásuvka a držák poznávací značky ■ Lighting set, 7PIN electric wiring in length - 10 m, width - 1,6 m. Lamps made with the very durable glass, reflective triangle, 7PIN socket and number plate holder ■ Beleuchtungssystem, 7PIN elektrische Verkabelung der eine Länge - 10 m, Breite - 1,6 m. Lampen aus hochfestem Glas, reflektierende Dreieck, 7PIN Schubladen und Nummernschildhalter ■ Система освещения, 7 контактная электропроводка длиной - 10 м, ширина - 1,6 м, лампы из высокопрочного стекла, светоотражающий треугольник, 7 контактный разъем и держатель номерного знака. 						
	<table border="1"> <tr> <td>722931</td> <td>12V</td> <td>P21W 12V, BA15s</td> </tr> <tr> <td>722950</td> <td>12V</td> <td>C5W 12V, SV8,5-8</td> </tr> </table>	722931	12V	P21W 12V, BA15s	722950	12V	C5W 12V, SV8,5-8
722931	12V	P21W 12V, BA15s					
722950	12V	C5W 12V, SV8,5-8					

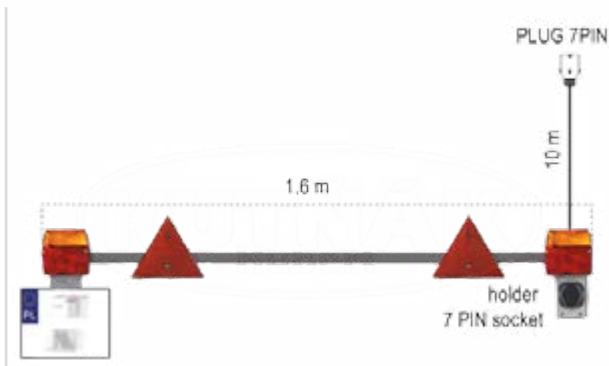

Lampa / Lamp / Lampe / Лампа		Kryt / Lens / Lichtscheibe / Крышка	Zástrčka / Plug / Stecker / Штекер
724620	Pravá / Right / Rechts / правая	724622	720538
724621	Levá / Left / Links / левая		
			Zásuvka / Socket / Buchse / Гнездо
			723053

KÓD / ORDER CODE / BESTELL NR. / КОД	POPIS / DESCRIPTION/ BESCHREIBUNG / ОПИСАНИЕ
724602	<p>12-24 V LED</p> <ul style="list-style-type: none"> ■ LED osvětlovací soustava, 7PIN elektrická kabeláž o délce - 10 m, šířka - 1,6 m. Lamps vyrobené z velmi odolného skla, reflexní trojúhelník, 7PIN zásuvka ■ LED lighting set, 7PIN electric wiring in length - 10 m, width - 1,6 m. Lamps made with the very durable glass, reflective triangle, 7PIN socket ■ LED beleuchtungssystem, 7PIN elektrische Verkabelung der eine Länge - 10 m, Breite - 1,6 m. Lampen aus hochfestem Glas, reflektierende Dreieck, 7PIN Schubladen ■ Светодиодная система освещения, 7 контактная электропроводка длиной - 10 м, ширина, 1,6 м, лампы из высокопрочного стекла, светоотражающий треугольник, 7 контактный разъем.



Lampa / Lamp / Lampe / Лампа	Zásuvka / Socket / Buchse / Гнездо	Zástrčka / Plug / Stecker / Штекер
724532	723053	720538

SADA ZADNÍCH SKUPINOVÝCH SVÍTELN / SET REAR LAMP / SET HECKLEUCHTE / KIT - ЗАДНИЕ ФОНАРИ

KÓD / ORDER CODE / BESTELL NR. / КОД	POPIS / DESCRIPTION/ BESCHREIBUNG / ОПИСАНИЕ						
724603	<ul style="list-style-type: none"> ■ Osvětlovací soustava, 7PIN elektrická kabeláž o délce - 10 m, šířka výsuvná od 1,6 m - 2,1 m. Lamps vyrobené z velmi odolného skla, reflexní trojúhelník, 7PIN zásuvka ■ Lighting set, 7PIN electric wiring in length - 10 m, width extendible from 1,6 m - 2,1 m. Lamps made with the very durable glass, reflective triangle, 7PIN socket ■ Beleuchtungssystem, 7PIN elektrische Verkabelung der eine Länge - 10 m, Breite ausziehbar von 1,6 m - 2,1 m. Lampen aus hochfestem Glas, reflektierende Dreieck, 7PIN Buchse ■ Система освещения, 7 контактная электропроводка длиной 10 м, ширина - увеличивается от 1,6 м, до 2,1 м, лампы из высокопрочного стекла, светоотражающий треугольник, 7 контактный разъем. 						
	<table border="1"> <tr> <td>722931</td> <td>12V</td> <td>P21W 12V, BA15s</td> </tr> <tr> <td>722950</td> <td>12V</td> <td>C5W 12V, SV8,5-8</td> </tr> </table>	722931	12V	P21W 12V, BA15s	722950	12V	C5W 12V, SV8,5-8
722931	12V	P21W 12V, BA15s					
722950	12V	C5W 12V, SV8,5-8					

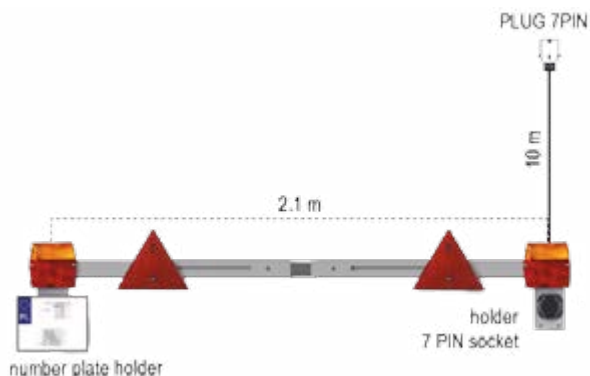

Lampa / Lamp / Lampe / Лампа		Kryt / Lens / Lichtscheibe / Крышка	Zástrčka / Plug / Stecker / Штекер
724620	Pravá / Right / Rechts / правая	724622	720538
724621	Levá / Left / Links / левая		
Trojúhelník / Triangle / Dreieck / Треугольник		Zásuvka / Socket / Buchse / Гнездо	
726757		723053	

KÓD / ORDER CODE / BESTELL NR. / КОД	POPIS / DESCRIPTION/ BESCHREIBUNG / ОПИСАНИЕ
724604	<p>12-24 V LED</p> <ul style="list-style-type: none"> ■ LED osvětlovací soustava, 7PIN elektrická kabeláž o délce - 10 m, šířka výsuvná od 1,6 m - 2,1 m. Lamps vyrobené z velmi odolného skla, reflexní trojúhelník, 7PIN zásuvka ■ LED lighting set, 7PIN electric wiring in length - 10 m, width extendible from 1,6 m - 2,1 m. Lamps made with the very durable glass, reflective triangle, 7PIN socket ■ LED beleuchtungssystem, 7PIN elektrische Verkabelung der eine Länge - 10 m, Breite ausziehbar von 1,6 m - 2,1 m. Lampen aus hochfestem Glas, reflektierende Dreieck, 7PIN Buchse ■ Светодиодная система освещения, 7 контактная электропроводка длиной 10 м, ширина увеличивается от 1,6 м до 2,1 м, лампы из высокопрочного стекла, светоотражающий треугольник, 7 контактный разъем.

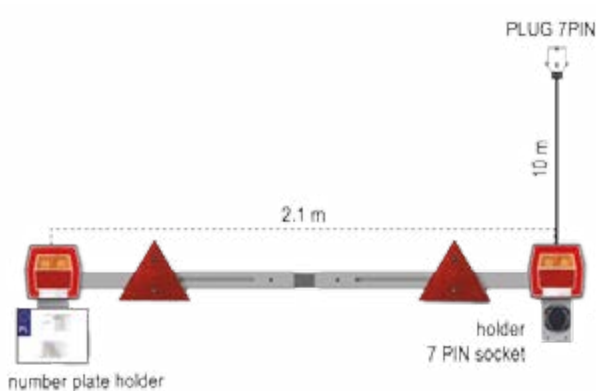

Trojúhelník / Triangle / Dreieck / Треугольник		Zásuvka / Socket / Buchse / Гнездо	Zástrčka / Plug / Stecker / Штекер
726757		723053	720538

SADA ZADNÍCH SKUPINOVÝCH SVÍTELN / SET REAR LAMP / SET HECKLEUCHTE / KIT - ЗАДНИЕ ФОНАРИ

KÓD / ORDER CODE / BESTELL NR. / КОД		POPIS / DESCRIPTION/ BESCHREIBUNG / ОПИСАНИЕ						
724605		<ul style="list-style-type: none"> ■ Sada dvou výstražných tabulí, jednostranné, 7PIN elektrická kabeláž o délce - 7,5 m, šířka - 3,6 m, dle normy DIN 11030 ■ Set of two warning boards, one-sided, 7PIN electrical wiring in length - 7,5 m, width - 3,6 meters, according to DIN 11030 ■ Zwei Warnbretter, einseitig, 7PIN elektrische Verkabelung in der Länge - 7,5 m, Breite - 3,6 m, nach DIN 11030 ■ Комплект из 2 знаков - досек предупреждения, односторонних, 7 контактной электропроводки длиной 7,5 м ширина - 3,6 м, согласно DIN 11030. 						
		<table border="1"> <tr> <td>722931</td> <td>12V</td> <td>P21W 12V, BA15s</td> </tr> <tr> <td>722950</td> <td>12V</td> <td>C5W 12V, SV8,5-8</td> </tr> </table>	722931	12V	P21W 12V, BA15s	722950	12V	C5W 12V, SV8,5-8
722931	12V	P21W 12V, BA15s						
722950	12V	C5W 12V, SV8,5-8						

Lampa / Lamp / Lampe / Лампа		Kryt / Lens / Lichtscheibe / Крышка	Zástrčka / Plug / Stecker / Штекер
724620	Pravá / Right / Rechts / правая	724622	720538
724621	Levá / Left / Links / левая		

KÓD / ORDER CODE / BESTELL NR. / КОД		POPIS / DESCRIPTION/ BESCHREIBUNG / ОПИСАНИЕ
724606		<p>12-24 V LED</p> <ul style="list-style-type: none"> ■ LED sada dvou výstražných tabulí, jednostranné, souprava je spojena dvěma vodiči - délka 10 m, zakončené 7 pinovým konektorem, dle normy DIN 11030 ■ LED set of two warning boards, one-sided, the set is connected with two wires - length 10 m, tipped with 7 PIN connector, DIN 11030 ■ LED Набор из двух предупреждающих досек, односторонних, набор связан с двумя проводами - длиной 10 м, прекращен 7-контактный разъем, DIN 11030 ■ Светодиодный набор из 2 знаков – досек предупреждения, односторонних, набор соединен двумя проводами длиной 10 м, а 7 контактным разъемом на конце, согласно DIN.

Zásuvka / Socket / Buchse / Гнездо	Zástrčka / Plug / Stecker / Штекер
723053	720538

SADA ZADNÍCH SKUPINOVÝCH SVÍTELN / SET REAR LAMP / SET HECKLEUCHTE / KIT - ЗАДНИЕ ФОНАРИ

KÓD / ORDER CODE / BESTELL NR. / КОД		POPIS / DESCRIPTION/ BESCHREIBUNG / ОПИСАНИЕ					
724607			<ul style="list-style-type: none"> ■ Sada dvou výstražných tabulí, dvoustrané, 7PIN elektrická kabeláž o délce - 5 m, šířka - 3,6 m, dle normy DIN 11030 ■ Set of two warning boards, double-sided, 7PIN electrical wiring in length - 5 m, width - 3,6 meters, according to DIN 11030 ■ Zwei Warnbretter, doppelseitig, 7PIN elektrische Verkabelung in der Länge - 5 m, Breite - 3,6 m, nach DIN 11030 ■ Набор из 2 знаков - досек предупреждения, односторонних, 7 контактной электропроводки длиной 5 м, ширина 3,6 м, согласно DIN 11030. 				
	<table border="1"> <tr> <td>722931</td> <td>12V</td> <td>P21W 12V, BA15s</td> </tr> <tr> <td>722950</td> <td>12V</td> <td>C5W 12V, SV8,5-8</td> </tr> </table>			722931	12V	P21W 12V, BA15s	722950
722931	12V	P21W 12V, BA15s					
722950	12V	C5W 12V, SV8,5-8					
Lampa / Lamp / Lampe / Лампа		Kryt / Lens / Lichtscheibe / Крышка					
724620	Pravá / Right / Rechts / правая	724622					
724621	Levá / Left / Links / левая						
		Zástrčka / Plug / Stecker / Штекер					
		720538					

KÓD / ORDER CODE / BESTELL NR. / КОД		POPIS / DESCRIPTION/ BESCHREIBUNG / ОПИСАНИЕ					
724608			<p>12-24 V LED</p> <ul style="list-style-type: none"> ■ LED sada čtyř výstražných tabulí, jednostranné, 7PIN elektrická kabeláž o délce - 7,5 m, šířka 4,4 m dle normy DIN 11030 ■ LED set of four warning boards, one-sided, 7PIN electrical wiring in length - 7,5 m, width 4,4 m, DIN 11030 ■ LED vier Warnbretter, 7PIN elektrische Verkabelung in der Länge - 7,5 m, breite 4,4 m, nach DIN 11030 ■ Светодиодный набор из 4 знаков досек - предупреждения, односторонних, 7 контактной электропроводки длиной 7,5 м, ширина 4,4 м, согласно DIN. 				
	<table border="1"> <tr> <td>Zásuvka / Socket / Buchse / Гнездо</td> <td>723053</td> <td></td> </tr> <tr> <td>Zástrčka / Plug / Stecker / Штекер</td> <td>720538</td> <td></td> </tr> </table>			Zásuvka / Socket / Buchse / Гнездо	723053		Zástrčka / Plug / Stecker / Штекер
Zásuvka / Socket / Buchse / Гнездо	723053						
Zástrčka / Plug / Stecker / Штекер	720538						



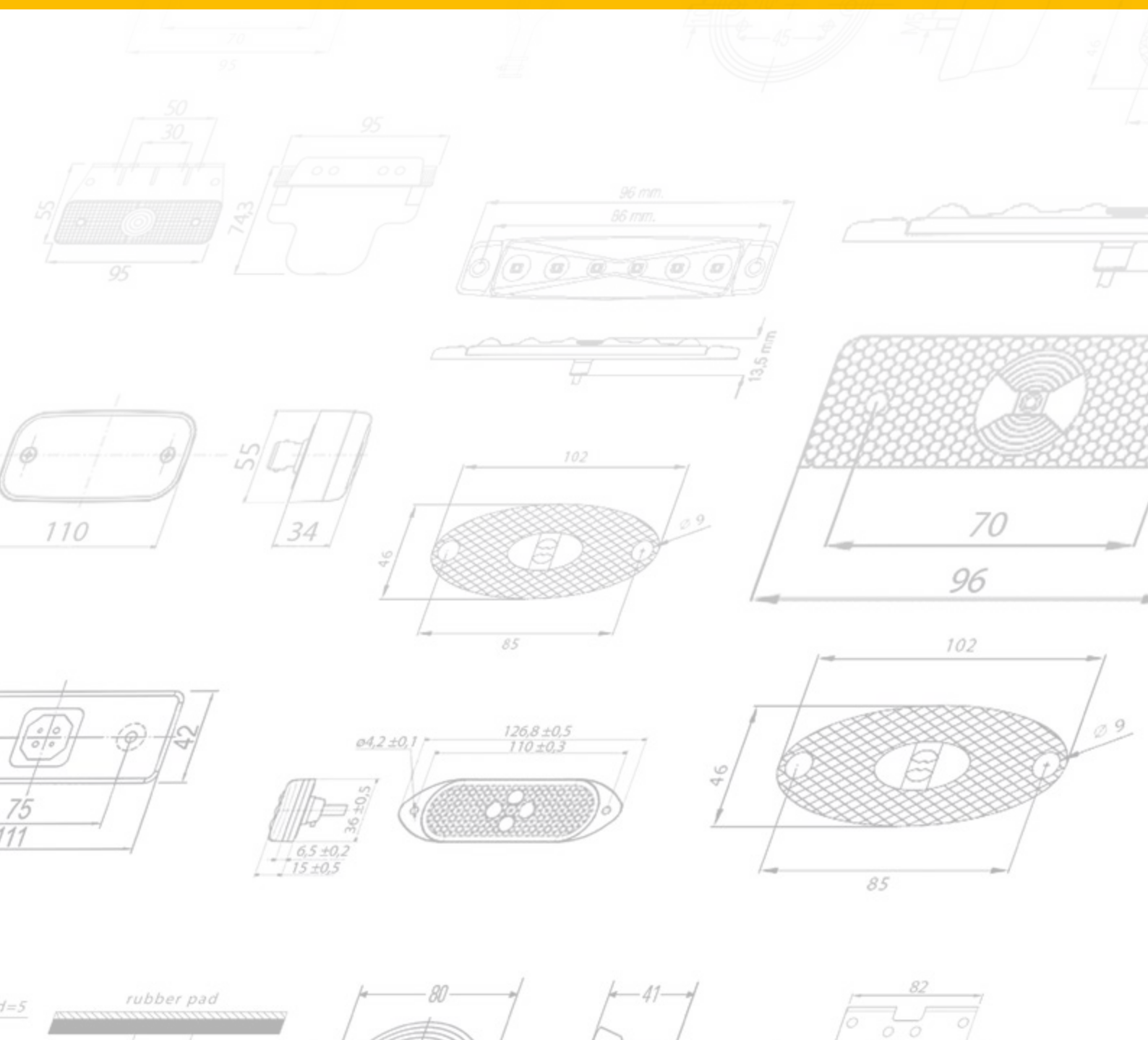



POZIČNÍ SVĚTLA, OBRYSOVÁ SVĚTLA, OSVĚTLENÍ SPZ /
MARKER LAMPS, OUTLINE MARKER LAMPS, ILLUMINATION
FOR NUMBERPLATE /
POSITIONSLEUCHTEN, UMRISSELEUCHTEN, KENNZEICHENLEUCHE/
ГАБАРИТНЫЕ ЛАМПЫ, КОНТУРНЫЕ ЛАМПЫ, ФОНАРЬ
ПОДСВЕТКИ НОМЕРНОГО ЗНАКА

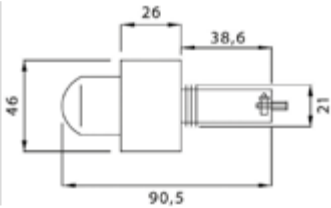

**POZIČNÍ SVĚTLA / MARKER LAMPS /
POSITIONSLEUCHTEN / ГАБАРИТНЫЕ ЛАМПЫ**

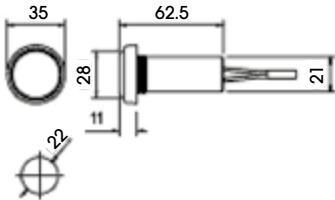
KÓD / ORDER CODE / BESTELL NR. / КОД		POPIS / DESCRIPTION / BESCHREIBUNG / ОПИСАНИЕ	OE / OE NUMBER / OE NUMBER / OE	NÁKRES / DRAWING / ZEICHNUNG / ЧЕРТЁЖ						
723985		SIDEPOINT <ul style="list-style-type: none"> ■ Kabel - 0,5 m ■ Cable - 0,5 m ■ Kabel - 0,5 m ■ Кабель - 0,5 м 	31-5004-097							
723982		SIDEPOINT <ul style="list-style-type: none"> ■ Kabel - 3,5 m ■ Cable - 3,5 m ■ Kabel - 3,5 m ■ Кабель - 3,5 м 	31-5004-087							
723984		SIDEPOINT <ul style="list-style-type: none"> ■ Kabel - 0,5 m ■ Cable - 0,5 m ■ Kabel - 0,5 m ■ Кабель - 0,5 м 	31-5004-007							
723986		SIDEPOINT <ul style="list-style-type: none"> ■ Kabel - 0,5 m ■ Cable - 0,5 m ■ Kabel - 0,5 m ■ Кабель - 0,5 м 	31-5064-027							
723987		SIDEPOINT <ul style="list-style-type: none"> ■ Kabel - 0,5 m ■ Cable - 0,5 m ■ Kabel - 0,5 m ■ Кабель - 0,5 м 	31-5064-067							
720477		<ul style="list-style-type: none"> ■ Kabel - 0,5 m ■ Cable - 0,5 m ■ Kabel - 0,5 m ■ Кабель - 0,5 м 	68-5000-017							
720478		<ul style="list-style-type: none"> ■ Kabel - 1 m ■ Cable - 1 m ■ Kabel - 1 m ■ Кабель - 1 м 	68-5000-027							
720474		<ul style="list-style-type: none"> ■ Kabel - 1,5 m ■ Cable - 1,5 m ■ Kabel - 1,5 m ■ Кабель - 1,5 м 	68-5000-037							
721468		<ul style="list-style-type: none"> ■ P & R ■ P & R klik ■ P & R klicken ■ P & R 	4260089	<table border="1"> <tr> <td>722948</td> <td>12V</td> <td>T4W 12V, BA9s</td> </tr> <tr> <td>722949</td> <td>24V</td> <td>T4W 24V, BA9s</td> </tr> </table>	722948	12V	T4W 12V, BA9s	722949	24V	T4W 24V, BA9s
722948	12V	T4W 12V, BA9s								
722949	24V	T4W 24V, BA9s								

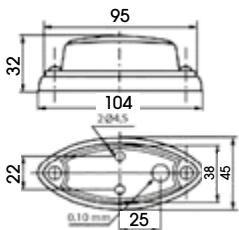
POZIČNÍ SVĚTLA / MARKER LAMPS / POSITIONSLEUCHTEN / ГАБАРИТНЫЕ ЛАМПЫ

KÓD / ORDER CODE / BESTELL NR. / КОД	POPIS / DESCRIPTION / BESCHREIBUNG / ОПИСАНИЕ	OE / OE NUMBER / OE NUMBER / OE	NÁKRES / DRAWING / ZEICHNUNG / ЧЕРТЁЖ						
720058		51 / 01 / 01							
			<table border="1"> <tr> <td>722940</td> <td>12V</td> <td>R5W 12V, BA15s</td> </tr> <tr> <td>722941</td> <td>24V</td> <td>R5W 24V, BA15s</td> </tr> </table>	722940	12V	R5W 12V, BA15s	722941	24V	R5W 24V, BA15s
722940	12V	R5W 12V, BA15s							
722941	24V	R5W 24V, BA15s							
KÓD / ORDER CODE / BESTELL NR. / КОД	POPIS / DESCRIPTION / BESCHREIBUNG / ОПИСАНИЕ	OE / OE NUMBER / OE NUMBER / OE	NÁKRES / DRAWING / ZEICHNUNG / ЧЕРТЁЖ						
720371		555 / 01 / 00							
			<table border="1"> <tr> <td>722954</td> <td>12V</td> <td>W3W 12V, W2,1x9,5d</td> </tr> <tr> <td>722955</td> <td>24V</td> <td>W3W 24V, W2,1x9,5d</td> </tr> </table>	722954	12V	W3W 12V, W2,1x9,5d	722955	24V	W3W 24V, W2,1x9,5d
722954	12V	W3W 12V, W2,1x9,5d							
722955	24V	W3W 24V, W2,1x9,5d							
KÓD / ORDER CODE / BESTELL NR. / КОД	POPIS / DESCRIPTION / BESCHREIBUNG / ОПИСАНИЕ	OE / OE NUMBER / OE NUMBER / OE	NÁKRES / DRAWING / ZEICHNUNG / ЧЕРТЁЖ						
721465		02070637							
721466	 <ul style="list-style-type: none"> ■ Kryt ■ Lens ■ Lichtscheibe ■ Крышка 	02077011							
			<table border="1"> <tr> <td>722950</td> <td>12V</td> <td>C5W 12V, SV8,5-8</td> </tr> <tr> <td>722951</td> <td>24V</td> <td>C5W 24V, SV8,5-8</td> </tr> </table>	722950	12V	C5W 12V, SV8,5-8	722951	24V	C5W 24V, SV8,5-8
722950	12V	C5W 12V, SV8,5-8							
722951	24V	C5W 24V, SV8,5-8							



**POZIČNÍ SVĚTLA / MARKER LAMPS /
POSITIONSLEUCHTEN / ГАБАРИТНЫЕ ЛАМПЫ**



KÓD / ORDER CODE / BESTELL NR. / КОД		POPIS / DESCRIPTION / BESCHREIBUNG / ОПИСАНИЕ	OE / OE NUMBER / OE NUMMER / OE	NÁKRES / DRAWING / ZEICHNUNG / ЧЕРТЁЖ						
727380			194130							
727379			194150							
				<table border="1"> <tr> <td>722948</td> <td>12V</td> <td>T4W 12V, BA9s</td> </tr> <tr> <td>722949</td> <td>24V</td> <td>T4W 24V, BA9s</td> </tr> </table>	722948	12V	T4W 12V, BA9s	722949	24V	T4W 24V, BA9s
722948	12V	T4W 12V, BA9s								
722949	24V	T4W 24V, BA9s								
KÓD / ORDER CODE / BESTELL NR. / КОД		POPIS / DESCRIPTION / BESCHREIBUNG / ОПИСАНИЕ	OE / OE NUMBER / OE NUMMER / OE	NÁKRES / DRAWING / ZEICHNUNG / ЧЕРТЁЖ						
723983		<p>FLEXIPOINT I.</p> <ul style="list-style-type: none"> ■ Kabel – 0,3 m ■ Cable – 0,3 m ■ Kabel – 0,3 m ■ Кабель – 0,3 м 	31-6504-087							
721468		<ul style="list-style-type: none"> ■ P & R ■ P & R click ■ P & R klicken ■ P & R 	4260089	<table border="1"> <tr> <td>722950</td> <td>12V</td> <td>C5W 12V, SV8,5-8</td> </tr> <tr> <td>722951</td> <td>24V</td> <td>C5W 24V, SV8,5-8</td> </tr> </table>	722950	12V	C5W 12V, SV8,5-8	722951	24V	C5W 24V, SV8,5-8
722950	12V	C5W 12V, SV8,5-8								
722951	24V	C5W 24V, SV8,5-8								
KÓD / ORDER CODE / BESTELL NR. / КОД		POPIS / DESCRIPTION / BESCHREIBUNG / ОПИСАНИЕ	OE / OE NUMBER / OE NUMMER / OE	NÁKRES / DRAWING / ZEICHNUNG / ЧЕРТЁЖ						
721803			2PF001259-631							
				<table border="1"> <tr> <td>722950</td> <td>12V</td> <td>C5W 12V, SV8,5-8</td> </tr> <tr> <td>722951</td> <td>24V</td> <td>C5W 24V, SV8,5-8</td> </tr> </table>	722950	12V	C5W 12V, SV8,5-8	722951	24V	C5W 24V, SV8,5-8
722950	12V	C5W 12V, SV8,5-8								
722951	24V	C5W 24V, SV8,5-8								

**POZIČNÍ SVĚTLA / MARKER LAMPS /
POSITIONSLEUCHTEN / ГАБАРИТНЫЕ ЛАМПЫ**

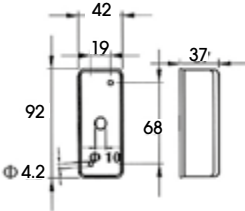

KÓD / ORDER CODE / BESTELL NR. / КОД		POPIS / DESCRIPTION / BESCHREIBUNG / ОПИСАНИЕ	OE / OE NUMBER / OE NUMMER / OE	NÁKRES / DRAWING / ZEICHNUNG / ЧЕРТЁЖ						
726862		<ul style="list-style-type: none"> ■ Kryt ■ Lens ■ Lichtscheibe ■ Крышка 								
726864		<ul style="list-style-type: none"> ■ Kryt + odrazka ■ Lens + reflex reflector ■ Lichtscheibe + Rückstrahler ■ Крышка + светоотражатель 								
726857		<ul style="list-style-type: none"> ■ Držák ■ Holder ■ Halter ■ Держатели 								
726860		<ul style="list-style-type: none"> ■ Držák ■ Holder ■ Halter ■ Держатели 								
726859		<ul style="list-style-type: none"> ■ Držák ■ Holder ■ Halter ■ Держатели 								
726858		<ul style="list-style-type: none"> ■ Držák s těsněním ■ Holder with gasket ■ Halter mit dichtung ■ Держатель с прокладкой 								
				<table border="1"> <tr> <td>722940</td> <td>12V</td> <td>R5W 12V, BA15s</td> </tr> <tr> <td>722941</td> <td>24V</td> <td>R5W 24V, BA15s</td> </tr> </table>	722940	12V	R5W 12V, BA15s	722941	24V	R5W 24V, BA15s
722940	12V	R5W 12V, BA15s								
722941	24V	R5W 24V, BA15s								

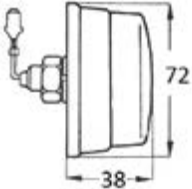
**POZIČNÍ SVĚTLA / MARKER LAMPS /
POSITIONSLEUCHTEN / ГАБАРИТНЫЕ ЛАМПЫ**

KÓD / ORDER CODE / BESTELL NR. / КОД		POPIS / DESCRIPTION / BESCHREIBUNG / ОПИСАНИЕ	OE / OE NUMBER / OE NUMBER / OE	NÁKRES / DRAWING / ZEICHNUNG / ЧЕРТЁЖ						
721599										
721646		<ul style="list-style-type: none"> ■ Kryt ■ Lens ■ Lichtscheibe ■ Крышка 								
				<table border="1"> <tr> <td>722940</td> <td>12V</td> <td>R5W 12V, BA15s</td> </tr> <tr> <td>722941</td> <td>24V</td> <td>R5W 24V, BA15s</td> </tr> </table>	722940	12V	R5W 12V, BA15s	722941	24V	R5W 24V, BA15s
722940	12V	R5W 12V, BA15s								
722941	24V	R5W 24V, BA15s								

KÓD / ORDER CODE / BESTELL NR. / КОД		POPIS / DESCRIPTION / BESCHREIBUNG / ОПИСАНИЕ	OE / OE NUMBER / OE NUMBER / OE	NÁKRES / DRAWING / ZEICHNUNG / ЧЕРТЁЖ						
721840		<ul style="list-style-type: none"> ■ Kabel - 0,1 m ■ Cable - 0,1 m ■ Kabel - 0,1 m ■ Кабель - 0,1 м 								
721841		<ul style="list-style-type: none"> ■ Kryt ■ Lens ■ Lichtscheibe ■ Крышка 								
				<table border="1"> <tr> <td>722950</td> <td>12V</td> <td>C5W 12V, SV8,5-8</td> </tr> <tr> <td>722951</td> <td>24V</td> <td>C5W 24V, SV8,5-8</td> </tr> </table>	722950	12V	C5W 12V, SV8,5-8	722951	24V	C5W 24V, SV8,5-8
722950	12V	C5W 12V, SV8,5-8								
722951	24V	C5W 24V, SV8,5-8								

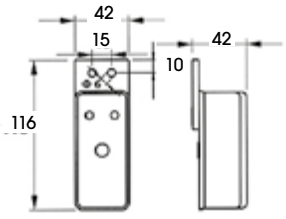
**POZIČNÍ SVĚTLA / MARKER LAMPS /
POSITIONSLEUCHTEN / ГАБАРИТНЫЕ ЛАМПЫ**

KÓD / ORDER CODE / BESTELL NR. / КОД		POPIS / DESCRIPTION / BESCHREIBUNG / ОПИСАНИЕ	OE / OE NUMBER / OE NUMMER / OE	NÁKRES / DRAWING / ZEICHNUNG / ЧЕРТЁЖ						
721595										
721954										
724961										
721638		<ul style="list-style-type: none"> ■ Kryt ■ Lens ■ Lichtscheibe ■ Крышка 								
				<table border="1"> <tr> <td>722940</td> <td>12V</td> <td>R5W 12V, BA15s</td> </tr> <tr> <td>722941</td> <td>24V</td> <td>R5W 24V, BA15s</td> </tr> </table>	722940	12V	R5W 12V, BA15s	722941	24V	R5W 24V, BA15s
722940	12V	R5W 12V, BA15s								
722941	24V	R5W 24V, BA15s								







**POZIČNÍ SVĚTLA / MARKER LAMPS /
POSITIONSLEUCHTEN / ГАБАРИТНЫЕ ЛАМПЫ**

KÓD / ORDER CODE / BESTELL NR. / КОД		POPIS / DESCRIPTION / BESCHREIBUNG / ОПИСАНИЕ	OE / OE NUMBER / OE NUMMER / OE	NÁKRES / DRAWING / ZEICHNUNG / ЧЕРТЁЖ						
721844		<ul style="list-style-type: none"> ■ Kabel – 0,1 m ■ Cable – 0,1 m ■ Kabel – 0,1 m ■ Кабель – 0,1 м 	194130							
721845		<ul style="list-style-type: none"> ■ Kryt ■ Lens ■ Lichtscheibe ■ Крышка 	194150							
				<table border="1"> <tr> <td>722950</td> <td>12V</td> <td>C5W 12V, SV8,5-8</td> </tr> <tr> <td>722951</td> <td>24V</td> <td>C5W 24V, SV8,5-8</td> </tr> </table>	722950	12V	C5W 12V, SV8,5-8	722951	24V	C5W 24V, SV8,5-8
722950	12V	C5W 12V, SV8,5-8								
722951	24V	C5W 24V, SV8,5-8								
KÓD / ORDER CODE / BESTELL NR. / КОД		POPIS / DESCRIPTION / BESCHREIBUNG / ОПИСАНИЕ	OE / OE NUMBER / OE NUMMER / OE	NÁKRES / DRAWING / ZEICHNUNG / ЧЕРТЁЖ						
721807										
				<table border="1"> <tr> <td>722950</td> <td>12V</td> <td>C5W 12V, SV8,5-8</td> </tr> <tr> <td>722951</td> <td>24V</td> <td>C5W 24V, SV8,5-8</td> </tr> </table>	722950	12V	C5W 12V, SV8,5-8	722951	24V	C5W 24V, SV8,5-8
722950	12V	C5W 12V, SV8,5-8								
722951	24V	C5W 24V, SV8,5-8								

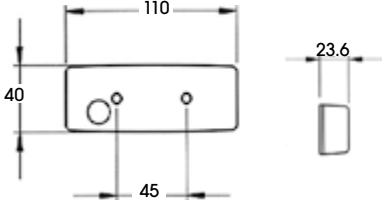

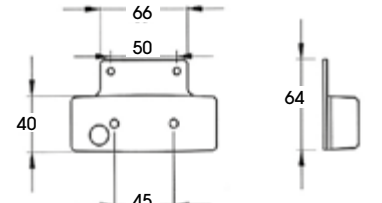

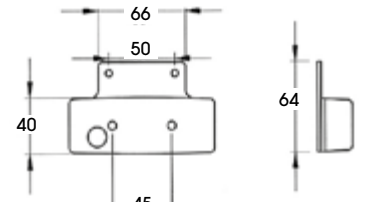

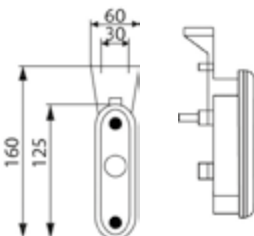

**POZIČNÍ SVĚTLA / MARKER LAMPS /
POSITIONSLEUCHTEN / ГАБАРИТНЫЕ ЛАМПЫ**

KÓD / ORDER CODE / BESTELL NR. / КОД		POPIS / DESCRIPTION / BESCHREIBUNG / ОПИСАНИЕ	OE / OE NUMBER / OE NUMBER / OE	NÁKRES / DRAWING / ZEICHNUNG / ЧЕРТЁЖ						
726865		<ul style="list-style-type: none"> ■ Kryt + odrazka ■ Lens + reflex reflector ■ Lichtscheibe + Rückstrahler ■ Крышка + светоотражатель 								
726857		<ul style="list-style-type: none"> ■ Držák ■ Holder ■ Halter ■ Держатели 								
726860		<ul style="list-style-type: none"> ■ Držák ■ Holder ■ Halter ■ Держатели 								
726859		<ul style="list-style-type: none"> ■ Držák ■ Holder ■ Halter ■ Держатели 								
726858		<ul style="list-style-type: none"> ■ Držák s těsněním ■ Holder with gasket ■ Halter mit dichtung ■ Держатель с прокладкой 								
				<table border="1"> <tr> <td>722940</td> <td>12V</td> <td>R5W 12V, BA15s</td> </tr> <tr> <td>722941</td> <td>24V</td> <td>R5W 24V, BA15s</td> </tr> </table>	722940	12V	R5W 12V, BA15s	722941	24V	R5W 24V, BA15s
722940	12V	R5W 12V, BA15s								
722941	24V	R5W 24V, BA15s								

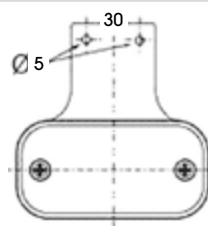

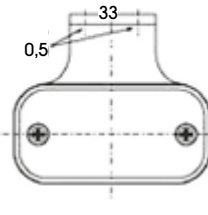

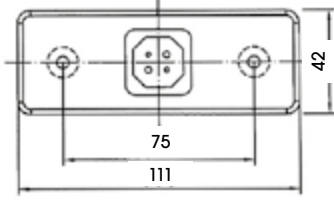

**POZIČNÍ SVĚTLA / MARKER LAMPS /
POSITIONSLEUCHTEN / ГАБАРИТНЫЕ ЛАМПЫ**

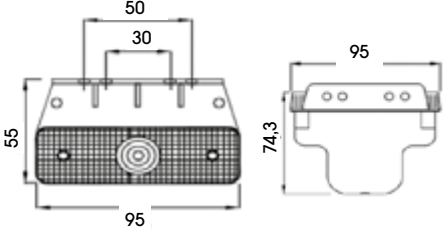

KÓD / ORDER CODE / BESTELL NR. / КОД		POPIS / DESCRIPTION / BESCHREIBUNG / ОПИСАНИЕ	OE / OE NUMBER / OE NUMBER / OE	NÁKRES / DRAWING / ZEICHNUNG / ЧЕРТЁЖ						
721647										
721650										
721652										
721657		<ul style="list-style-type: none"> ■ Kryt ■ Lens ■ Lichtscheibe ■ Крышка 								
				<table border="1"> <tr> <td>722954</td> <td>12V</td> <td>W3W 12V, W2,1x9,5d</td> </tr> <tr> <td>722955</td> <td>24V</td> <td>W3W 24V, W2,1x9,5d</td> </tr> </table>	722954	12V	W3W 12V, W2,1x9,5d	722955	24V	W3W 24V, W2,1x9,5d
722954	12V	W3W 12V, W2,1x9,5d								
722955	24V	W3W 24V, W2,1x9,5d								

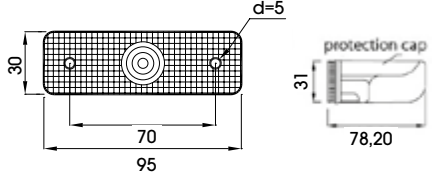
POZIČNÍ SVĚTLA / MARKER LAMPS / POSITIONSLEUCHTEN / ГАБАРИТНЫЕ ЛАМПЫ

KÓD / ORDER CODE / BESTELL NR. / КОД		POPIS / DESCRIPTION / BESCHREIBUNG / ОПИСАНИЕ	OE / OE NUMBER / OE NUMMER / OE	NÁKRES / DRAWING / ZEICHNUNG / ЧЕРТЁЖ						
722837		<ul style="list-style-type: none"> Červená + bílá + oranžová Red + white + orange Rot + weiss + orange Красная + Белая + оранжевая 	597 / 01 / 00							
				<table border="1"> <tr> <td>722954</td> <td>12V</td> <td>W3W 12V, W2,1x9,5d</td> </tr> <tr> <td>722955</td> <td>24V</td> <td>W3W 24V, W2,1x9,5d</td> </tr> </table>	722954	12V	W3W 12V, W2,1x9,5d	722955	24V	W3W 24V, W2,1x9,5d
722954	12V	W3W 12V, W2,1x9,5d								
722955	24V	W3W 24V, W2,1x9,5d								
KÓD / ORDER CODE / BESTELL NR. / КОД		POPIS / DESCRIPTION / BESCHREIBUNG / ОПИСАНИЕ	OE / OE NUMBER / OE NUMMER / OE	NÁKRES / DRAWING / ZEICHNUNG / ЧЕРТЁЖ						
726985			194010							
726984			194020							
726983			194030							
				<table border="1"> <tr> <td>722948</td> <td>12V</td> <td>T4W 12V, BA9s</td> </tr> <tr> <td>722949</td> <td>24V</td> <td>T4W 24V, BA9s</td> </tr> </table>	722948	12V	T4W 12V, BA9s	722949	24V	T4W 24V, BA9s
722948	12V	T4W 12V, BA9s								
722949	24V	T4W 24V, BA9s								
KÓD / ORDER CODE / BESTELL NR. / КОД		POPIS / DESCRIPTION / BESCHREIBUNG / ОПИСАНИЕ	OE / OE NUMBER / OE NUMMER / OE	NÁKRES / DRAWING / ZEICHNUNG / ЧЕРТЁЖ						
721272			0028207056							
720010		<ul style="list-style-type: none"> Opravná sada Repair kit Anschlusssatz Ремонтный комплект 		<table border="1"> <tr> <td>722954</td> <td>12V</td> <td>W3W 12V, W2,1x9,5d</td> </tr> <tr> <td>722955</td> <td>24V</td> <td>W3W 24V, W2,1x9,5d</td> </tr> </table>	722954	12V	W3W 12V, W2,1x9,5d	722955	24V	W3W 24V, W2,1x9,5d
722954	12V	W3W 12V, W2,1x9,5d								
722955	24V	W3W 24V, W2,1x9,5d								

POZIČNÍ SVĚTLA / MARKER LAMPS / POSITIONSLEUCHTEN / ГАБАРИТНЫЕ ЛАМПЫ

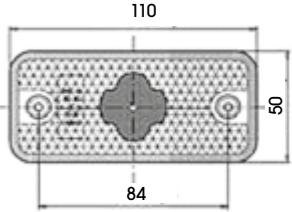
KÓD / ORDER CODE / BESTELL NR. / КОД		POPIS / DESCRIPTION / BESCHREIBUNG / ОПИСАНИЕ	OE / OE NUMBER / OE NUMBER / OE	NÁKRES / DRAWING / ZEICHNUNG / ЧЕРТЁЖ						
724027		SIDEPOINT <ul style="list-style-type: none"> ■ Kabel - 0,5 m ■ Cable - 0,5 m ■ Kabel - 0,5 m ■ Кабель - 0,5 м 	31-2814-007							
724024		SIDEPOINT <ul style="list-style-type: none"> ■ Kabel - 0,5 m ■ Cable - 0,5 m ■ Kabel - 0,5 m ■ Кабель - 0,5 м 	31-2814-047							
720477		<ul style="list-style-type: none"> ■ Kabel - 0,5 m ■ Cable - 0,5 m ■ Kabel - 0,5 m ■ Кабель - 0,5 м 	68-5000-017							
720478		<ul style="list-style-type: none"> ■ Kabel - 1 m ■ Cable - 1 m ■ Kabel - 1 m ■ Кабель - 1 м 	68-5000-027							
720474		<ul style="list-style-type: none"> ■ Kabel - 1,5 m ■ Cable - 1,5 m ■ Kabel - 1,5 m ■ Кабель - 1,5 м 	68-5000-037							
721468		<ul style="list-style-type: none"> ■ P & R ■ P & R click ■ P & R klicken ■ P & R 	4260089	<table border="1"> <tr> <td>722948</td> <td>12V</td> <td>T4W 12V, BA9s</td> </tr> <tr> <td>722949</td> <td>24V</td> <td>T4W 24V, BA9s</td> </tr> </table>	722948	12V	T4W 12V, BA9s	722949	24V	T4W 24V, BA9s
722948	12V	T4W 12V, BA9s								
722949	24V	T4W 24V, BA9s								

KÓD / ORDER CODE / BESTELL NR. / КОД		POPIS / DESCRIPTION / BESCHREIBUNG / ОПИСАНИЕ	OE / OE NUMBER / OE NUMBER / OE	NÁKRES / DRAWING / ZEICHNUNG / ЧЕРТЁЖ						
720112			193020							
725280		<ul style="list-style-type: none"> ■ Objímka ■ Bulb holder ■ Lampenfassung ■ патрон Лампы 	001726							
720006		<ul style="list-style-type: none"> ■ Opravná sada ■ Repair kit ■ Anschlusssatz ■ Ремонтный комплект 		<table border="1"> <tr> <td>722956</td> <td>12V</td> <td>W5W 12V, W2,1x9,5d</td> </tr> <tr> <td>722957</td> <td>24V</td> <td>W5W 24V, W2,1x9,5d</td> </tr> </table>	722956	12V	W5W 12V, W2,1x9,5d	722957	24V	W5W 24V, W2,1x9,5d
722956	12V	W5W 12V, W2,1x9,5d								
722957	24V	W5W 24V, W2,1x9,5d								

POZIČNÍ SVĚTLA / MARKER LAMPS / POSITIONSLEUCHTEN / ГАБАРИТНЫЕ ЛАМПЫ

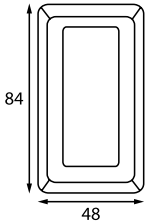
KÓD / ORDER CODE / BESTELL NR. / КОД		POPIS / DESCRIPTION / BESCHREIBUNG / ОПИСАНИЕ	OE / OE NUMBER / OE NUMMER / OE	NÁKRES / DRAWING / ZEICHNUNG / ЧЕРТЁЖ						
726867		<ul style="list-style-type: none"> ■ Kryt ■ Lens ■ Lichtscheibe ■ Крышка 								
726857		<ul style="list-style-type: none"> ■ Držák ■ Holder ■ Halter ■ держатели 								
726860		<ul style="list-style-type: none"> ■ Držák ■ Holder ■ Halter ■ держатели 								
726859		<ul style="list-style-type: none"> ■ Držák ■ Holder ■ Halter ■ держатели 								
726858		<ul style="list-style-type: none"> ■ Držák s těsněním ■ Holder with gasket ■ Halter mit dichtung ■ Держатель с прокладкой 								
				<table border="1"> <tr> <td>722940</td> <td>12V</td> <td>R5W 12V, BA15s</td> </tr> <tr> <td>722941</td> <td>24V</td> <td>R5W 24V, BA15s</td> </tr> </table>	722940	12V	R5W 12V, BA15s	722941	24V	R5W 24V, BA15s
722940	12V	R5W 12V, BA15s								
722941	24V	R5W 24V, BA15s								

**POZIČNÍ SVĚTLA / MARKER LAMPS /
POSITIONSLEUCHTEN / ГАБАРИТНЫЕ ЛАМПЫ**



KÓD / ORDER CODE / BESTELL NR. / КОД		POPIS / DESCRIPTION / BESCHREIBUNG / ОПИСАНИЕ	OE / OE NUMBER / OE NUMBER / OE	NÁKRES / DRAWING / ZEICHNUNG / ЧЕРТЁЖ						
721589			2XS005020-001							
721602			2XS005020-011							
721616			2XS005020-021							
721636		<ul style="list-style-type: none"> ■ Kryt ■ Lens ■ Lichtscheibe ■ Крышка 	9EL132215-001							
				<table border="1"> <tr> <td>722940</td> <td>12V</td> <td>R5W 12V, BA15s</td> </tr> <tr> <td>722941</td> <td>24V</td> <td>R5W 24V, BA15s</td> </tr> </table>	722940	12V	R5W 12V, BA15s	722941	24V	R5W 24V, BA15s
722940	12V	R5W 12V, BA15s								
722941	24V	R5W 24V, BA15s								

POZIČNÍ SVĚTLA / MARKER LAMPS / POSITIONSLEUCHTEN / ГАБАРИТНЫЕ ЛАМПЫ

KÓD / ORDER CODE / BESTELL NR. / КОД		POPIS / DESCRIPTION / BESCHREIBUNG / ОПИСАНИЕ	OE / OE NUMBER / OE NUMBER / OE	NÁKRES / DRAWING / ZEICHNUNG / ЧЕРТЁЖ						
722030			188010							
722031		<ul style="list-style-type: none"> ■ Kryt ■ Lens ■ Lichtscheibe ■ Крышка 	088010							
				<table border="1"> <tr> <td>722950</td> <td>12V</td> <td>C5W 12V, SV8,5-8</td> </tr> <tr> <td>722951</td> <td>24V</td> <td>C5W 24V, SV8,5-8</td> </tr> </table>	722950	12V	C5W 12V, SV8,5-8	722951	24V	C5W 24V, SV8,5-8
722950	12V	C5W 12V, SV8,5-8								
722951	24V	C5W 24V, SV8,5-8								
KÓD / ORDER CODE / BESTELL NR. / КОД		POPIS / DESCRIPTION / BESCHREIBUNG / ОПИСАНИЕ	OE / OE NUMBER / OE NUMBER / OE	NÁKRES / DRAWING / ZEICHNUNG / ЧЕРТЁЖ						
721594										
721572										
721631										
721640		<ul style="list-style-type: none"> ■ Kryt ■ Lens ■ Lichtscheibe ■ Крышка 								
				<table border="1"> <tr> <td>722940</td> <td>12V</td> <td>R5W 12V, BA15s</td> </tr> <tr> <td>722941</td> <td>24V</td> <td>R5W 24V, BA15s</td> </tr> </table>	722940	12V	R5W 12V, BA15s	722941	24V	R5W 24V, BA15s
722940	12V	R5W 12V, BA15s								
722941	24V	R5W 24V, BA15s								

Important notice: part of other producers are only mentioned for comparison purposes.

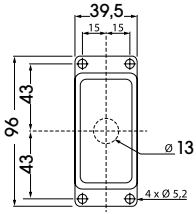
**POZIČNÍ SVĚTLA / MARKER LAMPS /
POSITIONSLEUCHTEN / ГАБАРИТНЫЕ ЛАМПЫ**

KÓD / ORDER CODE / BESTELL NR. / КОД		POPIS / DESCRIPTION / BESCHREIBUNG / ОПИСАНИЕ	OE / OE NUMBER / OE NUMBER / OE	NÁKRES / DRAWING / ZEICHNUNG / ЧЕРТЁЖ						
721302			187730							
721289		<ul style="list-style-type: none"> ■ Kryt ■ Lens ■ Lichtscheibe ■ Крышка 	087030							
				<table border="1"> <tr> <td>722950</td> <td>12V</td> <td>C5W 12V, SV8,5-8</td> </tr> <tr> <td>722951</td> <td>24V</td> <td>C5W 24V, SV8,5-8</td> </tr> </table>	722950	12V	C5W 12V, SV8,5-8	722951	24V	C5W 24V, SV8,5-8
722950	12V	C5W 12V, SV8,5-8								
722951	24V	C5W 24V, SV8,5-8								

KÓD / ORDER CODE / BESTELL NR. / КОД		POPIS / DESCRIPTION / BESCHREIBUNG / ОПИСАНИЕ	OE / OE NUMBER / OE NUMBER / OE	NÁKRES / DRAWING / ZEICHNUNG / ЧЕРТЁЖ						
721804			2SA001259-751							
				<table border="1"> <tr> <td>722950</td> <td>12V</td> <td>C5W 12V, SV8,5-8</td> </tr> <tr> <td>722951</td> <td>24V</td> <td>C5W 24V, SV8,5-8</td> </tr> </table>	722950	12V	C5W 12V, SV8,5-8	722951	24V	C5W 24V, SV8,5-8
722950	12V	C5W 12V, SV8,5-8								
722951	24V	C5W 24V, SV8,5-8								

POZIČNÍ SVĚTLA / MARKER LAMPS / POSITIONSLEUCHTEN / ГАБАРИТНЫЕ ЛАМПЫ



KÓD / ORDER CODE / BESTELL NR. / КОД		POPIS / DESCRIPTION / BESCHREIBUNG / ОПИСАНИЕ	OE / OE NUMBER / OE NUMMER / OE	NÁKRES / DRAWING / ZEICHNUNG / ЧЕРТЁЖ						
726861		<ul style="list-style-type: none"> ■ Kryt ■ Lens ■ Lichtscheibe ■ Крышка 								
726866		<ul style="list-style-type: none"> ■ Kryt ■ Lens ■ Lichtscheibe ■ Крышка 								
726857		<ul style="list-style-type: none"> ■ Držák ■ Holder ■ Halter ■ держатель 								
726860		<ul style="list-style-type: none"> ■ Držák ■ Holder ■ Halter ■ держатель 								
726859		<ul style="list-style-type: none"> ■ Držák ■ Holder ■ Halter ■ держатель 								
726858		<ul style="list-style-type: none"> ■ Držák s těsněním ■ Holder with gasket ■ Halter mit dichtung ■ Держатель с прокладкой 								
				<table border="1"> <tr> <td>722940</td> <td>12V</td> <td>R5W 12V, BA15s</td> </tr> <tr> <td>722941</td> <td>24V</td> <td>R5W 24V, BA15s</td> </tr> </table>	722940	12V	R5W 12V, BA15s	722941	24V	R5W 24V, BA15s
722940	12V	R5W 12V, BA15s								
722941	24V	R5W 24V, BA15s								

Important notice: part of other producers are only mentioned for comparison purposes.

**POZIČNÍ SVĚTLA / MARKER LAMPS /
POSITIONSLEUCHTEN / ГАБАРИТНЫЕ ЛАМПЫ**

KÓD / ORDER CODE / BESTELL NR. / КОД		POPIS / DESCRIPTION / BESCHREIBUNG / ОПИСАНИЕ	OE / OE NUMBER / OE NUMBER / OE	NÁKRES / DRAWING / ZEICHNUNG / ЧЕРТЁЖ						
721582			2XS005020-041							
721607			2XS005020-091							
721635		<ul style="list-style-type: none"> ■ Kryt ■ Lens ■ Lichtscheibe ■ Крышка 	9EL132215-011							
				<table border="1"> <tr> <td>722940</td> <td>12V</td> <td>R5W 12V, BA15s</td> </tr> <tr> <td>722941</td> <td>24V</td> <td>R5W 24V, BA15s</td> </tr> </table>	722940	12V	R5W 12V, BA15s	722941	24V	R5W 24V, BA15s
722940	12V	R5W 12V, BA15s								
722941	24V	R5W 24V, BA15s								
KÓD / ORDER CODE / BESTELL NR. / КОД		POPIS / DESCRIPTION / BESCHREIBUNG / ОПИСАНИЕ	OE / OE NUMBER / OE NUMBER / OE	NÁKRES / DRAWING / ZEICHNUNG / ЧЕРТЁЖ						
727381			194310							
				<table border="1"> <tr> <td>722948</td> <td>12V</td> <td>T4W 12V, BA9s</td> </tr> <tr> <td>722949</td> <td>24V</td> <td>T4W 24V, BA9s</td> </tr> </table>	722948	12V	T4W 12V, BA9s	722949	24V	T4W 24V, BA9s
722948	12V	T4W 12V, BA9s								
722949	24V	T4W 24V, BA9s								

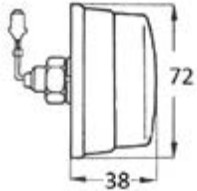
**POZIČNÍ SVĚTLA / MARKER LAMPS /
POSITIONSLEUCHTEN / ГАБАРИТНЫЕ ЛАМПЫ**

KÓD / ORDER CODE / BESTELL NR. / КОД		POPIS / DESCRIPTION / BESCHREIBUNG / ОПИСАНИЕ	OE / OE NUMBER / OE NUMMER / OE	NÁKRES / DRAWING / ZEICHNUNG / ЧЕРТЁЖ						
721842		<ul style="list-style-type: none"> ■ Kabel – 0,1 m ■ Cable – 0,1 m ■ Kabel – 0,1 m ■ Кабель – 0,1 м 								
721843		<ul style="list-style-type: none"> ■ Kryt ■ Lens ■ Lichtscheibe ■ Крышка 								
				<table border="1"> <tr> <td>722950</td> <td>12V</td> <td>C5W 12V, SV8,5-8</td> </tr> <tr> <td>722951</td> <td>24V</td> <td>C5W 24V, SV8,5-8</td> </tr> </table>	722950	12V	C5W 12V, SV8,5-8	722951	24V	C5W 24V, SV8,5-8
722950	12V	C5W 12V, SV8,5-8								
722951	24V	C5W 24V, SV8,5-8								

OBRYSOVÁ SVĚTLA / OUTLINE MARKER LAMPS / UMRISSLEUCHTEN / ГАБАРИТНЫЕ ЛАМПЫ

KÓD / ORDER CODE / BESTELL NR. / КОД		POPIS / DESCRIPTION / BESCHREIBUNG / ОПИСАНИЕ	OE / OE NUMBER / OE NUMBER / OE	NÁKRES / DRAWING / ZEICHNUNG / ЧЕРТЁЖ						
720255		<ul style="list-style-type: none"> Červená + bílá, pryžové rameno 60 °, kabel - 0,15 m Red + white, rubber arm 60 °, cable - 0,15 m Rot + weiss, gummiarm 60 °, kabel - 0,15 m Красная + Белая, резиновый рукав 60 °, кабель - 0,15 м 								
720254		<ul style="list-style-type: none"> Červená + bílá, pryžové rameno 90 °, kabel - 0,15m Red + white, rubber arm 90 °, cable - 0,15 m Rot + weiss, gummiarm 90 °, kabel - 0,15 m Красная + Белая, резиновый рукав 90 °, кабель - 0,15 м 								
727236		<ul style="list-style-type: none"> Červené sklo Red glass Rot glas Красное стекло 								
727235		<ul style="list-style-type: none"> Čiré sklo Clear glass Klar glas Прозрачное стекло 								
727207		<ul style="list-style-type: none"> Objímka + kabel Bulb holder + cable for outline marker Lampenfassung + kabel für umriss патрон лампы + провод 								
				<table border="1"> <tr> <td>722940</td> <td>12V</td> <td>R5W 12V, BA15s</td> </tr> <tr> <td>722941</td> <td>24V</td> <td>R5W 24V, BA15s</td> </tr> </table>	722940	12V	R5W 12V, BA15s	722941	24V	R5W 24V, BA15s
722940	12V	R5W 12V, BA15s								
722941	24V	R5W 24V, BA15s								

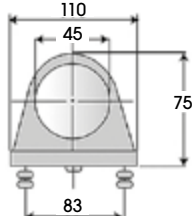
KÓD / ORDER CODE / BESTELL NR. / КОД		POPIS / DESCRIPTION / BESCHREIBUNG / ОПИСАНИЕ	OE / OE NUMBER / OE NUMBER / OE	NÁKRES / DRAWING / ZEICHNUNG / ЧЕРТЁЖ						
720411		<ul style="list-style-type: none"> Červená + bílá, kabel - 0,15 m Red + white, cable - 0,15 m Rot + weiss, kabel - 0,15 m Красная + Белая, кабель - 0,15 м 								
				<table border="1"> <tr> <td>722940</td> <td>12V</td> <td>R5W 12V, BA15s</td> </tr> <tr> <td>722941</td> <td>24V</td> <td>R5W 24V, BA15s</td> </tr> </table>	722940	12V	R5W 12V, BA15s	722941	24V	R5W 24V, BA15s
722940	12V	R5W 12V, BA15s								
722941	24V	R5W 24V, BA15s								



OBRYSOVÁ SVĚTLA / OUTLINE MARKER LAMPS / UMRISSELEUCHTEN / ГАБАРИТНЫЕ ЛАМПЫ

KÓD / ORDER CODE / BESTELL NR. / КОД	POPIS / DESCRIPTION / BESCHREIBUNG / ОПИСАНИЕ	OE / OE NUMBER / OE NUMBER / OE	NÁKRES / DRAWING / ZEICHNUNG / ЧЕРТЁЖ
725520 PRAVÁ / RIGHT / RECHTS / Правая	<ul style="list-style-type: none"> Červená + bílá + oranžová, kabel - 0,1 m Red + white + orange, cable - 0,1 m Rot + weiss + orange, kabel - 0,1 m Красная + Белая + оранжевая, кабель - 0,1 м 	31-3306-067	
725521 LEVÁ / LEFT / LINKS / Левая	<ul style="list-style-type: none"> Červená + bílá + oranžová, kabel - 0,1 m Red + white + orange, cable - 0,1 m Rot + weiss + orange, kabel - 0,1 m Красная + Белая + оранжевая, кабель - 0,1 м 	31-3305-067	
725523 PRAVÁ / RIGHT / RECHTS / Правая	<ul style="list-style-type: none"> Červená + bílá + oranžová, kabel - 0,1 m Red + white + orange, cable - 0,1 m Rot + weiss + orange, kabel - 0,1 m Красная + Белая + оранжевая, кабель - 0,1 м 	31-3302-027	
725522 LEVÁ / LEFT / LINKS / Левая	<ul style="list-style-type: none"> Červená + bílá + oranžová, kabel - 0,1 m Red + white + orange, cable - 0,1 m Rot + weiss + orange, kabel - 0,1 m Красная + Белая + оранжевая, кабель - 0,1 м 	31-3303-027	
725505 PRAVÁ / RIGHT / RECHTS / Правая	<ul style="list-style-type: none"> Červená + bílá + oranžová, kabel - 0,25 m Red + white + orange, cable - 0,25 m Rot + weiss + orange, kabel - 0,25 m Красная + Белая + оранжевая, кабель - 0,25 м 	31-3302-037 31-3302-034	
725504 LEVÁ / LEFT / LINKS / Левая	<ul style="list-style-type: none"> Červená + bílá + oranžová, kabel - 0,25 m Red + white + orange, cable - 0,25 m Rot + weiss + orange, kabel - 0,25 m Красная + Белая + оранжевая, кабель - 0,25 м 	31-3303-037 31-3303-034	
			722948 12V T4W 12V, BA9s 722949 24V T4W 24V, BA9s

OBRYSOVÁ SVĚTLA / OUTLINE MARKER LAMPS / UMRISSLEUCHTEN / ГАБАРИТНЫЕ ЛАМПЫ

KÓD / ORDER CODE / BESTELL NR. / КОД		POPIS / DESCRIPTION / BESCHREIBUNG / ОПИСАНИЕ	OE / OE NUMBER / OE NUMBER / OE	NÁKRES / DRAWING / ZEICHNUNG / ЧЕРТЁЖ						
726823		<ul style="list-style-type: none"> Červená + bílá + oranžová, pryžové rameno, kabel - 0,7 m Red + white + orange, rubber arm, cable - 0,7 m Rot + weiss + orange, gummiarm, kabel - 0,7 m Красная + Белая + оранжевая, резиновый рукав, кабель - 0,7 м 								
726824 PRAVÁ / RIGHT / RECHTS / Правая		<ul style="list-style-type: none"> Červená + bílá + oranžová, pryžové rameno, kabel - 0,7 m Red + white + orange, rubber arm, cable - 0,7 m Rot + weiss + orange, gummiarm, kabel - 0,7 m Красная + Белая + оранжевая, резиновый рукав, кабель - 0,7 м 								
726825 LEVÁ / LEFT / LINKS / Левая		<ul style="list-style-type: none"> Červená + bílá + oranžová, pryžové rameno, kabel - 0,7 m Red + white + orange, rubber arm, cable - 0,7 m Rot + weiss + orange, gummiarm, kabel - 0,7 m Красная + Белая + Оранжевая, резиновый рукав, кабель - 0,7 м 								
726820 PRAVÁ / RIGHT / RECHTS / Правая		<ul style="list-style-type: none"> Červená + bílá + oranžová, pryžové rameno, kabel - 0,7 m Red + white + orange, rubber arm, cable - 0,7 m Rot + weiss + orange, gummiarm, kabel - 0,7 m Красная + Белая + оранжевая, резиновый рукав, кабель - 0,7 м 								
726821 LEVÁ / LEFT / LINKS / Левая		<ul style="list-style-type: none"> Červená + bílá + oranžová, pryžové rameno, kabel - 0,7 m Red + white + orange, rubber arm, cable - 0,7 m Rot + weiss + orange, gummiarm, kabel - 0,7 m Красная + Белая + оранжевая, резиновый рукав, кабель - 0,7 м 								
721531		<ul style="list-style-type: none"> Sklo, červené + bílé + oranžové Glass, red + white + orange Glas, rot + weiss + orange стекло красно + бело + Оранжевое 	18-8136-007							
721532		<ul style="list-style-type: none"> Sklo, černé + bílé + oranžové Glass, black + white + orange Glas, schwarz + weiss + orange стекло, черно + бело + Оранжевое 	18-8137-007							
725386		<ul style="list-style-type: none"> Objímka + kabel - 0,5 m Bulb holder + cable - 0,5 m Lampenfassung + kabel - 0,5 m патрон лампы + провод - 0,5 м 	31-2800-007							
725387		<ul style="list-style-type: none"> Objímka + kabel - 2 m Bulb holder + cable - 2 m Lampenfassung + kabel - 2 m патрон лампы + провод - 2 м 	31-2800-027							
			4260089	<table border="1"> <tr> <td>722948</td> <td>12V</td> <td>T4W 12V, BA9s</td> </tr> <tr> <td>722949</td> <td>24V</td> <td>T4W 24V, BA9s</td> </tr> </table>	722948	12V	T4W 12V, BA9s	722949	24V	T4W 24V, BA9s
722948	12V	T4W 12V, BA9s								
722949	24V	T4W 24V, BA9s								

OBRYSOVÁ SVĚTLA / OUTLINE MARKER LAMPS / UMRISSELEUCHTEN / ГАБАРИТНЫЕ ЛАМПЫ

KÓD / ORDER CODE / BESTELL NR. / КОД		POPIS / DESCRIPTION / BESCHREIBUNG / ОПИСАНИЕ	OE / OE NUMBER / OE NUMMER / OE	NÁKRES / DRAWING / ZEICHNUNG / ЧЕРТЁЖ						
726822		<ul style="list-style-type: none"> Červená + bílá + oranžová, pryžové rameno, kabel - 0,7 m Red + white + orange, rubber arm, cable - 0,7 m Rot + weiss + orange, gummiarm, kabel - 0,7 m Красная + Белая + оранжевая, резиновый рукав, кабель - 0,7 м 								
726818 PRAVÁ / RIGHT / RECHTS / Правая		<ul style="list-style-type: none"> Červená + bílá + oranžová, pryžové rameno, kabel - 0,7 m Red + white + orange, rubber arm, cable - 0,7 m Rot + weiss + orange, gummiarm, kabel - 0,7 m Красная + Белая + оранжевая, резиновый рукав, кабель - 0,7 м 								
726819 LEVÁ / LEFT / LINKS / Левая		<ul style="list-style-type: none"> Červená + bílá + oranžová, pryžové rameno, kabel - 0,7 m Red + white + orange, rubber arm, cable - 0,7 m Rot + weiss + orange, gummiarm, kabel - 0,7 m Красная + Белая + оранжевая, резиновый рукав, кабель - 0,7 м 								
721531		<ul style="list-style-type: none"> Sklo, červené + bílé + oranžové Glass, red + white + orange Glas, rot + weiss + orange стекло красно + бело + Оранжевое 	18-8136-007							
721532		<ul style="list-style-type: none"> Sklo, černé + bílé + oranžové Glass, black + white + orange Glas, schwarz + weiss + orange стекло, черно + бело + Оранжевое 	18-8137-007							
721468		<ul style="list-style-type: none"> P & R P & R click P & R klicken P & R 	4260089	<table border="1"> <tr> <td>722948</td> <td>12V</td> <td>T4W 12V, BA9s</td> </tr> <tr> <td>722949</td> <td>24V</td> <td>T4W 24V, BA9s</td> </tr> </table>	722948	12V	T4W 12V, BA9s	722949	24V	T4W 24V, BA9s
722948	12V	T4W 12V, BA9s								
722949	24V	T4W 24V, BA9s								







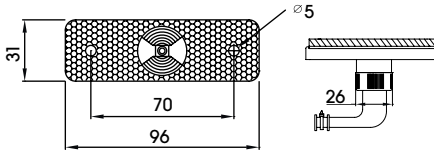

OBRYSOVÁ SVĚTLA / OUTLINE MARKER LAMPS / UMRISSLEUCHTEN / ГАБАРИТНЫЕ ЛАМПЫ

KÓD / ORDER CODE / BESTELL NR. / КОД		POPIS / DESCRIPTION / BESCHREIBUNG / ОПИСАНИЕ	OE / OE NUMBER / OE NUMMER / OE	NÁKRES / DRAWING / ZEICHNUNG / ЧЕРТЁЖ						
720606 PRAVÁ / RIGHT / RECHTS / Правая		<ul style="list-style-type: none"> ■ Červená + bílá + oranžová, kabel - 0,1 m ■ Red + white + orange, cable - 0,1 m ■ Rot + weiss + orange, kabel - 0,1 m ■ Красная + Белая + оранжевая, кабель - 0,1 м 								
720607 LEVÁ / LEFT / LINKS / Левая		<ul style="list-style-type: none"> ■ Červená + bílá + oranžová, kabel - 0,1 m ■ Red + white + orange, cable - 0,1 m ■ Rot + weiss + orange, kabel - 0,1 m ■ Красная + Белая + оранжевая, кабель - 0,1 м 								
				<table border="1"> <tr> <td>722948</td> <td>12V</td> <td>T4W 12V, BA9s</td> </tr> <tr> <td>722949</td> <td>24V</td> <td>T4W 24V, BA9s</td> </tr> </table>	722948	12V	T4W 12V, BA9s	722949	24V	T4W 24V, BA9s
722948	12V	T4W 12V, BA9s								
722949	24V	T4W 24V, BA9s								

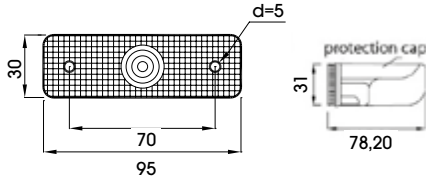

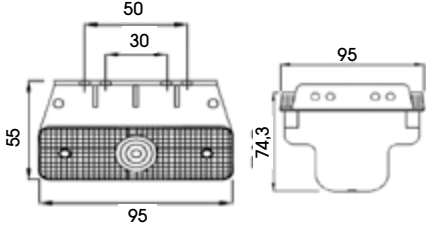



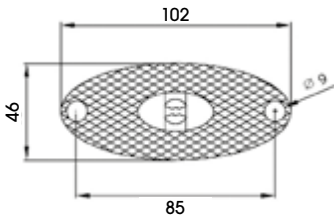

**POZIČNÍ SVĚTLA 12 V / MARKER LAMPS 12 V /
POSITIONSLEUCHTEN 12 V / ГАБАРИТНЫЕ ЛАМПЫ 12 V**

KÓD / ORDER CODE / BESTELL NR. / КОД		POPIS / DESCRIPTION / BESCHREIBUNG / ОПИСАНИЕ	OE / OE NUMBER / OE NUMMER / OE	NÁKRES / DRAWING / ZEICHNUNG / ЧЕРТЁЖ
721969		<ul style="list-style-type: none"> ■ 6x LED, kabel - 0,7 m ■ 6x LED, cable - 0,7 m ■ 6x leuchtdioden, kabel - 0,7 m ■ 6x светодиодный, кабель - 0,7 м 		
721971		<ul style="list-style-type: none"> ■ 6x LED, kabel - 0,7 m ■ 6x LED, cable - 0,7 m ■ 6x leuchtdioden, kabel - 0,7 m ■ 6x светодиодный, кабель - 0,7 м 		
721973		<ul style="list-style-type: none"> ■ 6x LED, kabel - 0,7 m ■ 6x LED, cable - 0,7 m ■ 6x leuchtdioden, kabel - 0,7 m ■ 6x светодиодный, кабель - 0,7 м 		

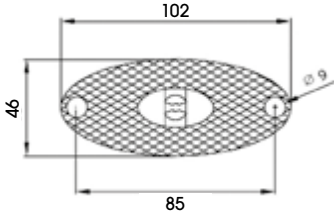

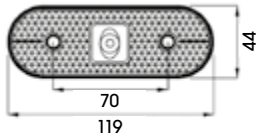

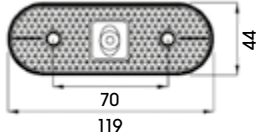

**POZIČNÍ SVĚTLA 24 V / MARKER LAMPS 24 V /
POSITIONSLEUCHTEN 24 V / ГАБАРИТНЫЕ ЛАМПЫ 24 V**

KÓD / ORDER CODE / BESTELL NR. / КОД		POPIS / DESCRIPTION / BESCHREIBUNG / ОПИСАНИЕ	OE / OE NUMBER / OE NUMBER / OE	NÁKRES / DRAWING / ZEICHNUNG / ЧЕРТЁЖ
726953		FLATPOINT <ul style="list-style-type: none"> ■ Kabel - 0,5 m ■ Cable - 0,5 m ■ Kabel - 0,5 m ■ кабель - 0,5 м 	31-6604-077	
723992		FLATPOINT <ul style="list-style-type: none"> ■ Kabel - 1,5 m ■ Cable - 1,5 m ■ Kabel - 1,5 m ■ кабель - 1,5 м 	31-6614-037	
726661		FLATPOINT <ul style="list-style-type: none"> ■ Kabel - 1,5 m ■ Cable - 1,5 m ■ Kabel - 1,5 m ■ КАБЕЛЬ - 1,5 м 	31-6614-077	
720477		<ul style="list-style-type: none"> ■ Kabel - 0,5 m ■ Cable - 0,5 m ■ Kabel - 0,5 m ■ Ка́бель - 0,5 м 	68--5000-017	
720478		<ul style="list-style-type: none"> ■ Kabel - 1 m ■ Cable - 1 m ■ Kabel - 1 m ■ Ка́бель - 1 м 	68-5000-027	
720474		<ul style="list-style-type: none"> ■ Kabel - 1,5 m ■ Cable - 1,5 m ■ Kabel - 1,5 m ■ Ка́бель - 1,5 м 	68-5000-037	
721468		<ul style="list-style-type: none"> ■ P & R ■ P & R click ■ P & R klicken ■ P & R 	4260089	

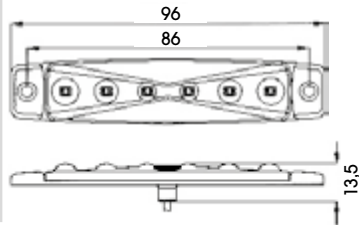

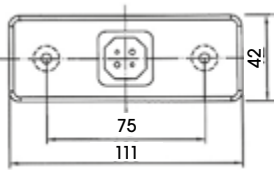

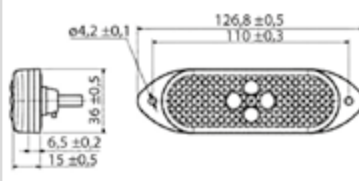

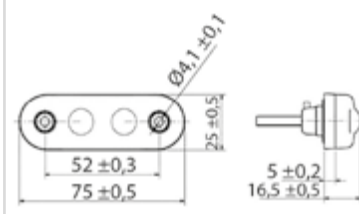

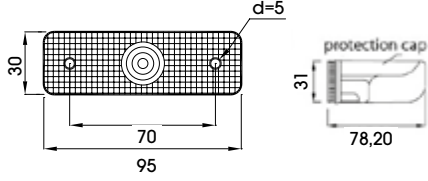

**POZIČNÍ SVĚTLA 24 V / MARKER LAMPS 24 V /
POSITIONSLEUCHTEN 24 V / ГАБАРИТНЫЕ ЛАМПЫ 24 V**

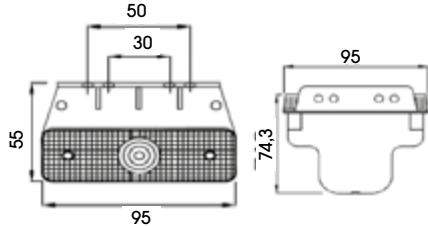
KÓD / ORDER CODE / BESTELL NR. / КОД		POPIS / DESCRIPTION / BESCHREIBUNG / ОПИСАНИЕ	OE / OE NUMBER / OE NUMBER / OE	NÁKRES / DRAWING / ZEICHNUNG / ЧЕРТЁЖ
724018		FLATPOINT II. <ul style="list-style-type: none"> ■ Kabel - 0,5 m ■ Cable - 0,5 m ■ Kabel - 0,5 m ■ кабель - 0,5 м 	31-6904-017	
724688		FLATPOINT II. <ul style="list-style-type: none"> ■ Kabel - 1,5 m ■ Cable - 1,5 m ■ Kabel - 1,5 m ■ кабель - 1,5 м 	31-6904-037	
721468		<ul style="list-style-type: none"> ■ P & R ■ P & R Click ■ P & R Klicken ■ P & R 	4260089	
KÓD / ORDER CODE / BESTELL NR. / КОД		POPIS / DESCRIPTION / BESCHREIBUNG / ОПИСАНИЕ	OE / OE NUMBER / OE NUMBER / OE	NÁKRES / DRAWING / ZEICHNUNG / ЧЕРТЁЖ
725540		UNIPOINT <ul style="list-style-type: none"> ■ Kabel - 0,5 m ■ Cable - 0,5 m ■ Kabel - 0,5 m ■ кабель - 0,5 м 	31-7704-017	
725539		UNIPOINT <ul style="list-style-type: none"> ■ Kabel - 1,5 m ■ Cable - 1,5 m ■ Kabel - 1,5 m ■ кабель - 1,5 м 	31-7704-037	
722529		<ul style="list-style-type: none"> ■ Náhradní kabel pro FLATPOINT - 1,5 m ■ Connection cable P & R for FLATPOINT - 1,5 m ■ Anschlusskabel P & R für FLATPOINT - 1,5 m ■ запасной кабель для FLATPOINT - 1,5 м 	68-5018-024	
721468		<ul style="list-style-type: none"> ■ P & R ■ P & R click ■ P & R klicken ■ P & R 	4260089	

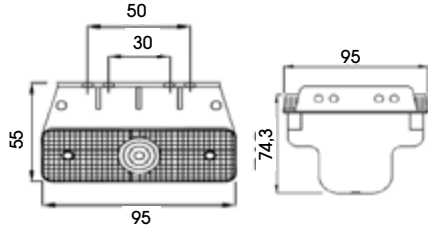

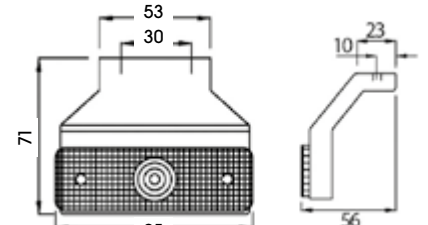







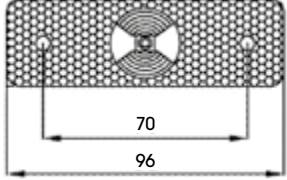

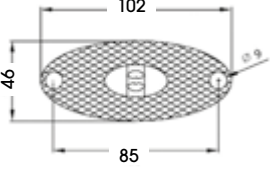
**POZIČNÍ SVĚTLA 24 V / MARKER LAMPS 24 V /
POSITIONSLEUCHTEN 24 V / ГАБАРИТНЫЕ ЛАМПЫ 24 V**

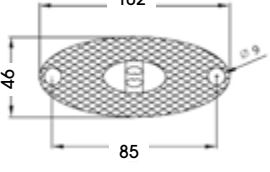
KÓD / ORDER CODE / BESTELL NR. / КОД		POPIS / DESCRIPTION / BESCHREIBUNG / ОПИСАНИЕ	OE / OE NUMBER / OE NUMBER / OE	NÁKRES / DRAWING / ZEICHNUNG / ЧЕРТЁЖ
721970		<ul style="list-style-type: none"> ■ 6x LED, kabel - 0,7 m ■ 6x LED, cable - 0,7 m ■ 6x leuchtdioden, kabel - 0,7 m ■ 6x светодиодный, кабель - 0,7 м 		
720261		<ul style="list-style-type: none"> ■ 4x LED, kabel - 0,5 m ■ 4x LED, cable - 0,5 m ■ 4x leuchtdioden, kabel - 0,5 m ■ 4x светодиодный, кабель - 0,5 м 		
721468		<ul style="list-style-type: none"> ■ P & R ■ P & R click ■ P & R klicken ■ P & R 	4260089	
721304		<ul style="list-style-type: none"> ■ 4x LED, kabel - 0,5 m ■ 4x LED, cable - 0,5 m ■ 4x leuchtdioden, kabel - 0,5 m ■ 4x светодиодный, кабель - 0,5 м 	104130	
721468		<ul style="list-style-type: none"> ■ P & R ■ P & R click ■ P & R klicken ■ P & R 	4260089	
720470		<ul style="list-style-type: none"> ■ 2x LED, kabel - 0,5 m ■ 2x LED, cable - 0,5 m ■ 2x leuchtdioden, kabel - 0,5 m ■ 2x светодиодный, кабель - 0,5 м 	104290	

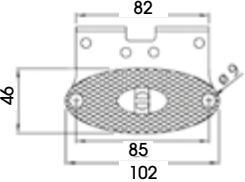
**POZIČNÍ SVĚTLA 24 V / MARKER LAMPS 24 V /
POSITIONSLEUCHTEN 24 V / ГАБАРИТНЫЕ ЛАМПЫ 24 V**

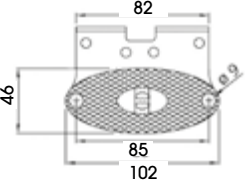
KÓD / ORDER CODE / BESTELL NR. / КОД		POPIS / DESCRIPTION / BESCHREIBUNG / ОПИСАНИЕ	OE / OE NUMBER / OE NUMBER / OE	NÁKRES / DRAWING / ZEICHNUNG / ЧЕРТЁЖ
724044		FLATPOINT <ul style="list-style-type: none"> ■ Kabel - 0,5 m ■ Cable - 0,5 m ■ Kabel - 0,5 m ■ кабель - 0,5 м 	31-2214-117	
726956		FLATPOINT <ul style="list-style-type: none"> ■ Kabel - 0,5 m ■ Cable - 0,5 m ■ Kabel - 0,5 m ■ кабель - 0,5 м 	31-2214-017	
726965		FLATPOINT <ul style="list-style-type: none"> ■ Kabel - 1,5 m ■ Cable - 1,5 m ■ Kabel - 1,5 m ■ кабель - 1,5 м 	31-2214-037	
724045		FLATPOINT <ul style="list-style-type: none"> ■ Kabel - 0,5 m ■ Cable - 0,5 m ■ Kabel - 0,5 m ■ кабель - 0,5 м 	31-2264-017	
720477		<ul style="list-style-type: none"> ■ Kabel - 0,5 m ■ Cable - 0,5 m ■ Kabel - 0,5 m ■ кабель - 0,5 м 	68-5000-017	
720478		<ul style="list-style-type: none"> ■ Kabel - 1 m ■ Cable - 1 m ■ Kabel - 1 m ■ Ка́бель - 1 м 	68-5000-027	
720474		<ul style="list-style-type: none"> ■ Kabel - 1,5 m ■ Cable - 1,5 m ■ Kabel - 1,5 m ■ кабель - 1,5 м 	68-5000-037	
721468		<ul style="list-style-type: none"> ■ P & R ■ P & R Click ■ P & R Klicken ■ P & R 	4260089	

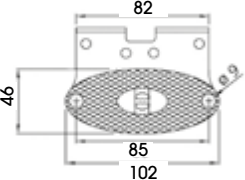







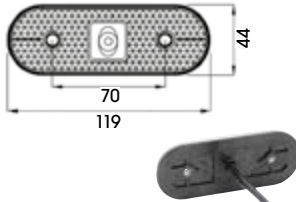

**POZIČNÍ SVĚTLA 24 V / MARKER LAMPS 24 V /
POSITIONSLEUCHTEN 24 V / ГАБАРИТНЫЕ ЛАМПЫ 24 V**

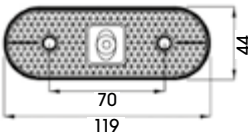
KÓD / ORDER CODE / BESTELL NR. / КОД		POPIS / DESCRIPTION / BESCHREIBUNG / ОПИСАНИЕ	OE / OE NUMBER / OE NUMMER / OE	NÁKRES / DRAWING / ZEICHNUNG / ЧЕРТЁЖ
725145		FLATPOINT <ul style="list-style-type: none"> ■ Bez kabelu ■ Without cable ■ Ohne kable ■ без провода 	21-2200-004	
725165		<ul style="list-style-type: none"> ■ Opravná sada ■ Repair kit ■ Anschlusssatz ■ Ремонтный комплект 	15-2122-104	
KÓD / ORDER CODE / BESTELL NR. / КОД		POPIS / DESCRIPTION / BESCHREIBUNG / ОПИСАНИЕ	OE / OE NUMBER / OE NUMMER / OE	NÁKRES / DRAWING / ZEICHNUNG / ЧЕРТЁЖ
726992		FLATPOINT II. <ul style="list-style-type: none"> ■ Kabel - 0,5 m ■ Cable - 0,5 m ■ Kabel - 0,5 m ■ Кабель - 0,5 м 	31-2304-017	
726996		FLATPOINT II. <ul style="list-style-type: none"> ■ Kabel - 1,5 m ■ Cable - 1,5 m ■ Kabel - 1,5 m ■ Кабель - 1,5 м 	31-2304-037	
726659		FLATPOINT II. <ul style="list-style-type: none"> ■ Kabel - 0,5 m ■ Cable - 0,5 m ■ Kabel - 0,5 m ■ Кабель - 0,5 м 	31-2364-087	
726664		FLATPOINT II. <ul style="list-style-type: none"> ■ Kabel - 1,5 m ■ Cable - 1,5 m ■ Kabel - 1,5 m ■ Кабель - 1,5 м 	31-2364-107	
724049		FLATPOINT II. <ul style="list-style-type: none"> ■ Kabel - 0,5 m ■ Cable - 0,5 m ■ Kabel - 0,5 m ■ Кабель - 0,5 м 	31-2364-017	
721468		<ul style="list-style-type: none"> ■ P & R ■ P & R Click ■ P & R Klicken ■ P & R 	4260089	

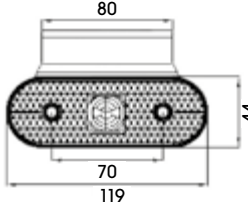

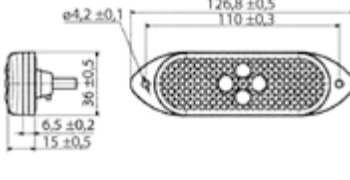

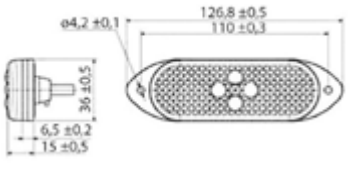

**POZIČNÍ SVĚTLA 24 V / MARKER LAMPS 24 V /
POSITIONSLEUCHTEN 24 V / ГАБАРИТНЫЕ ЛАМПЫ 24 V**

KÓD / ORDER CODE / BESTELL NR. / КОД		POPIS / DESCRIPTION / BESCHREIBUNG / ОПИСАНИЕ	OE / OE NUMBER / OE NUMBER / OE	NÁKRES / DRAWING / ZEICHNUNG / ЧЕРТЁЖ
724051		UNIPOINT <ul style="list-style-type: none"> ■ Kabel - 0,5 m ■ Cable - 0,5 m ■ Kabel - 0,5 m ■ Кабель - 0,5 м 	31-2004-017	
726955		UNIPOINT <ul style="list-style-type: none"> ■ Kabel - 0,5 m ■ Cable - 0,5 m ■ Kabel - 0,5 m ■ Кабель - 0,5 м 	31-2064-017	
726963		UNIPOINT <ul style="list-style-type: none"> ■ Kabel - 1,5 m ■ Cable - 1,5 m ■ Kabel - 1,5 m ■ Кабель - 1,5 м 	31-2064-037	
724052		UNIPOINT <ul style="list-style-type: none"> ■ Kabel - 0,5 m ■ Cable - 0,5 m ■ Kabel - 0,5 m ■ Кабель - 0,5 м 	31-2064-717	
724120		UNIPOINT <ul style="list-style-type: none"> ■ Kabel - 0,5 m ■ Cable - 0,5 m ■ Kabel - 0,5 m ■ Кабель - 0,5 м 	31-2064-217	
722529		<ul style="list-style-type: none"> ■ Náhradní kabel pro UNIPOINT - 1,5 m ■ Connection cable P&R for UNIPOINT - 1,5 m ■ Anschlusskabel P&R für FLATPOINT - 1,5 m ■ запасной кабель для FLATPOINT - 1,5 м 	68-5018-024	
721468		<ul style="list-style-type: none"> ■ P & R ■ P & R Click ■ P & R Klicken ■ P & R 	4260089	

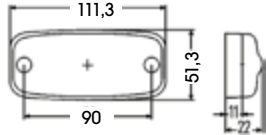

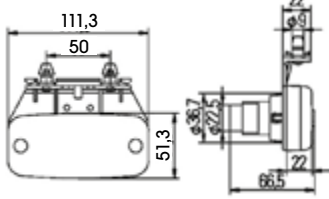

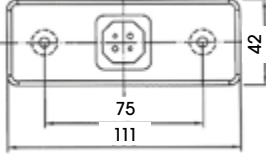

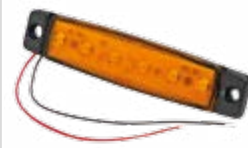
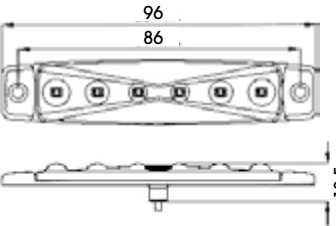

**POZIČNÍ SVĚTLA 24 V / MARKER LAMPS 24 V /
POSITIONSLEUCHTEN 24 V / ГАБАРИТНЫЕ ЛАМПЫ 24 V**

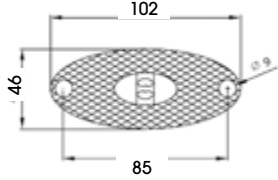
KÓD / ORDER CODE / BESTELL NR. / КОД		POPIS / DESCRIPTION / BESCHREIBUNG / ОПИСАНИЕ	OE / OE NUMBER / OE NUMMER / OE	NÁKRES / DRAWING / ZEICHNUNG / ЧЕРТЁЖ
724050		UNIPOINT	31-2104-017	
721468		<ul style="list-style-type: none"> ■ P & R ■ P & R Click ■ P & R Klicken ■ P & R 	4260089	
726978		UNIPOINT <ul style="list-style-type: none"> ■ Bez kabelu ■ Without cable ■ Ohne kable ■ Без провода 	21-2000-004	
726962		UNIPOINT <ul style="list-style-type: none"> ■ Bez kabelu ■ Without cable ■ Ohne kable ■ Без провода 	21-2000-045	
722525		<ul style="list-style-type: none"> ■ Opravná sada ■ Repair kit ■ Abschlussatz ■ Ремонтный комплект 	15-5624-024	
720458		<ul style="list-style-type: none"> ■ 4x LED, kabel - 1,5 m ■ 4x LED, cable - 1,5 m ■ 4x Leuchtdioden, kabel - 1,5 m ■ 4x Светодиодный, Кабель - 1,5 м 		
721311		<ul style="list-style-type: none"> ■ 4x LED, kabel - 0,3 m ■ 4x LED, cable - 0,3 m ■ 4x Leuchtdioden, kabel - 0,3 m ■ 4x Светодиодный, Кабель - 0,3 м 		
721468		<ul style="list-style-type: none"> ■ P & R ■ P & R Click ■ P & R Klicken ■ P & R 	4260089	

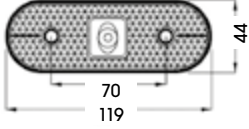

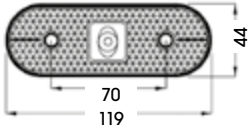

**POZIČNÍ SVĚTLA 24 V / MARKER LAMPS 24 V /
POSITIONSLEUCHTEN 24 V / ГАБАРИТНЫЕ ЛАМПЫ 24 V**

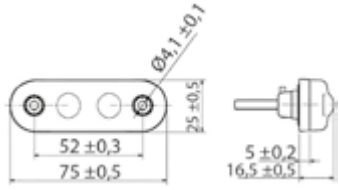
KÓD / ORDER CODE / BESTELL NR. / КОД		POPIS / DESCRIPTION / BESCHREIBUNG / ОПИСАНИЕ	OE / OE NUMBER / OE NUMBER / OE	NÁKRES / DRAWING / ZEICHNUNG / ЧЕРТЁЖ
722181		<ul style="list-style-type: none"> ■ 3x LED, kabel - 0,3 m ■ 3x LED, cable - 0,3 m ■ 3x Leuchtdioden, kabel - 0,3 m ■ 3x Светодиодный, Кабель - 0,3 м 	2PS963639-011	
722180		<ul style="list-style-type: none"> ■ 3x LED, kabel - 0,3 m ■ 3x LED, cable - 0,3 m ■ 3x Leuchtdioden, kabel - 0,3 m ■ 3x Светодиодный, Кабель - 0,3 м 	2PS340001-001	
KÓD / ORDER CODE / BESTELL NR. / КОД		POPIS / DESCRIPTION / BESCHREIBUNG / ОПИСАНИЕ	OE / OE NUMBER / OE NUMBER / OE	NÁKRES / DRAWING / ZEICHNUNG / ЧЕРТЁЖ
722764		<ul style="list-style-type: none"> ■ 4x LED, kabel - 0,5 m ■ 4x LED, cable - 0,5 m ■ 4x Leuchtdioden, kabel - 0,5 m ■ 4x Светодиодный, Кабель - 0,5 м 		
721468		<ul style="list-style-type: none"> ■ P & R ■ P & R Click ■ P & R Klicken ■ P & R 	4260089	
KÓD / ORDER CODE / BESTELL NR. / КОД		POPIS / DESCRIPTION / BESCHREIBUNG / ОПИСАНИЕ	OE / OE NUMBER / OE NUMBER / OE	NÁKRES / DRAWING / ZEICHNUNG / ЧЕРТЁЖ
721972		<ul style="list-style-type: none"> ■ 6x LED, kabel - 0,7 m ■ 6x LED, cable - 0,7 m ■ 6x Leuchtdioden, kabel - 0,7 m ■ 6x Светодиодный, Кабель - 0,7 м 		

**POZIČNÍ SVĚTLA 24 V / MARKER LAMPS 24 V /
POSITIONSLEUCHTEN 24 V / ГАБАРИТНЫЕ ЛАМПЫ 24 V**

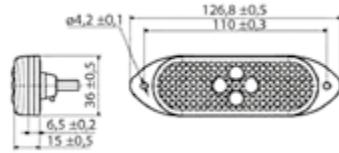
KÓD / ORDER CODE / BESTELL NR. / КОД		POPIS / DESCRIPTION / BESCHREIBUNG / ОПИСАНИЕ	OE / OE NUMBER / OE NUMBER / OE	NÁKRES / DRAWING / ZEICHNUNG / ЧЕРТЁЖ
724019		FLATPOINT II. <ul style="list-style-type: none"> ■ Kabel - 0,5 m ■ Cable - 0,5 m ■ Kabel - 0,5 m ■ Кабель - 0,5 м 	31-6404-017	
721468		<ul style="list-style-type: none"> ■ P & R ■ P & R Click ■ P & R Klicken ■ P & R 	4260089	
KÓD / ORDER CODE / BESTELL NR. / КОД		POPIS / DESCRIPTION / BESCHREIBUNG / ОПИСАНИЕ	OE / OE NUMBER / OE NUMBER / OE	NÁKRES / DRAWING / ZEICHNUNG / ЧЕРТЁЖ
723969		UNIPOINT <ul style="list-style-type: none"> ■ Kabel - 0,5 m ■ Cable - 0,5 m ■ Kabel - 0,5 m ■ Кабель - 0,5 м 	31-7804-017	
723970		UNIPOINT <ul style="list-style-type: none"> ■ Kabel - 3,5 m ■ Cable - 3,5 m ■ Kabel - 3,5 m ■ Кабель - 3,5 м 	31-7804-057	
722529		<ul style="list-style-type: none"> ■ Náhradní kabel pro UNIPOINT - 1,5 m ■ Connection cable P&R for UNIPOINT - 1,5m ■ Anschlusskabel P&R für FLATPOINT - 1,5 m ■ запасной кабель для FLATPOINT - 1,5 м 	68-5018-024	
721468		<ul style="list-style-type: none"> ■ P & R ■ P & R Click ■ P & R Klicken ■ P & R 	4260089	
KÓD / ORDER CODE / BESTELL NR. / КОД		POPIS / DESCRIPTION / BESCHREIBUNG / ОПИСАНИЕ	OE / OE NUMBER / OE NUMBER / OE	NÁKRES / DRAWING / ZEICHNUNG / ЧЕРТЁЖ
721360		<ul style="list-style-type: none"> ■ 2x LED, kabel - 0,5 m ■ 2x LED, cable - 0,5 m ■ 2x Leuchtdioden, kabel - 0,5 m ■ 2x Светодиодный, Кабель - 0,5 м 	104330	

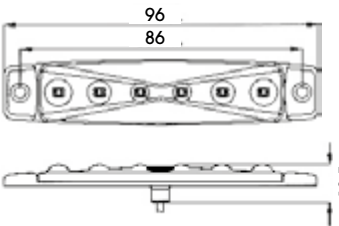

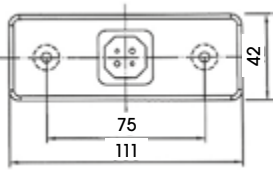



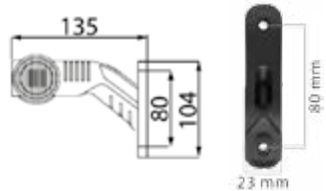

**POZIČNÍ SVĚTLA 24 V / MARKER LAMPS 24 V /
POSITIONSLEUCHTEN 24 V / ГАБАРИТНЫЕ ЛАМПЫ 24 V**

KÓD / ORDER CODE / BESTELL NR. / КОД		POPIS / DESCRIPTION / BESCHREIBUNG / ОПИСАНИЕ	OE / OE NUMBER / OE NUMBER / OE	NÁKRES / DRAWING / ZEICHNUNG / ЧЕРТЁЖ
721361		<ul style="list-style-type: none"> ■ 4x LED, kabel - 0,5 m ■ 4x LED, cable - 0,5 m ■ 4x Leuchtdioden, kabel - 0,5 m ■ 4x Светодиодный, Кабель - 0,5 м 	104170	
721468		<ul style="list-style-type: none"> ■ P & R ■ P & R Click ■ P & R Klicken ■ P & R 	4260089	
KÓD / ORDER CODE / BESTELL NR. / КОД		POPIS / DESCRIPTION / BESCHREIBUNG / ОПИСАНИЕ	OE / OE NUMBER / OE NUMBER / OE	NÁKRES / DRAWING / ZEICHNUNG / ЧЕРТЁЖ
721974		<ul style="list-style-type: none"> ■ 6x LED, kabel - 0,7 m ■ 6x LED, cable - 0,7 m ■ 6x Leuchtdioden, kabel - 0,7 m ■ 6x Светодиодный, Кабель - 0,7 м 		
726550		<ul style="list-style-type: none"> ■ 4x LED, kabel - 0,5 m ■ 4x LED, cable - 0,5 m ■ 4x Leuchtdioden, kabel - 0,5 m ■ 4x Светодиодный, Кабель - 0,5 м 		

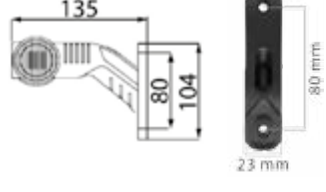
OBRYSOVÁ SVĚTLA 24 V / OUTLINE MARKER LAMPS 24 V / UMRISSLEUCHTEN 24 V / ГАБАРИТНЫЕ ЛАМПЫ 24 V

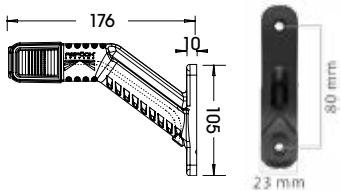
KÓD / ORDER CODE / BESTELL NR. / КОД		POPIS / DESCRIPTION / BESCHREIBUNG / ОПИСАНИЕ	OE / OE NUMBER / OE NUMBER / OE	NÁKRES / DRAWING / ZEICHNUNG / ЧЕРТЁЖ
724112 PRAVÁ / RIGHT / RECHTS / Правая		SUPERPOINT III. <ul style="list-style-type: none"> Červená + bílá + oranžová, kabel - 1,25 m Red + white + orange, cable - 1,25 m Rot + weiss + orange, kabel - 1,25 m Красная + Белая + Оранжевая, Кабель -1,25 м 	31-3304-057	
724114 LEVÁ / LEFT / LINKS / Левая		SUPERPOINT III. <ul style="list-style-type: none"> Červená + bílá + oranžová, kabel - 1,25 m Red + white + orange, cable - 1,25 m Rot + weiss + orange, kabel - 1,25 m Красная + Белая + Оранжевая, Кабель -1,25 м 	31-3304-047	
724167		SUPERPOINT III. <ul style="list-style-type: none"> Červená + bílá + oranžová, kabel - 1,25 m Red + white + orange, cable - 1,25 m Rot + weiss + orange, kabel - 1,25 m Красная + Белая + Оранжевая, Кабель -1,25 м 	31-3304-097	
724155 PRAVÁ / RIGHT / RECHTS / Правая		SUPERPOINT III. <ul style="list-style-type: none"> Červená + bílá + oranžová, kabel - 1,25 m Red + white + orange, cable - 1,25 m Rot + weiss + orange, kabel - 1,25 m Красная + Белая + Оранжевая, Кабель -1,25 м 	31-3364-027	
724162 LEVÁ / LEFT / LINKS / Левая		SUPERPOINT III. <ul style="list-style-type: none"> Červená + bílá + oranžová, kabel - 1,25 m Red + white + orange, cable - 1,25 m Rot + weiss + orange, kabel - 1,25 m Красная + Белая + Оранжевая, Кабель -1,25 м 	31-3364-057	
724131		SUPERPOINT III. <ul style="list-style-type: none"> Červená + bílá + oranžová, kabel - 1,25 m Red + white + orange, cable - 1,25 m Rot + weiss + orange, kabel - 1,25 m Красная + Белая + Оранжевая, Кабель -1,25 м 	31-3364-007	
724123		SUPERPOINT III. <ul style="list-style-type: none"> Červená + bílá + oranžová, kabel - 1,25 m Red + white + orange, cable - 1,25 m Rot + weiss + orange, kabel - 1,25 m Красная + Белая + Оранжевая, Кабель -1,25 м 	21-3351-707	
721468		<ul style="list-style-type: none"> P & R P & R Click P & R Klicken P & R 	4260089	

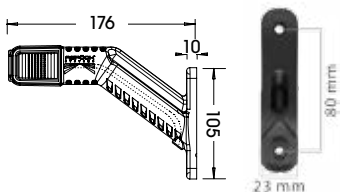
OBRYSOVÁ SVĚTLA 24 V / OUTLINE MARKER LAMPS 24 V / UMRISSELEUCHTEN 24 V / ГАБАРИТНЫЕ ЛАМПЫ 24 V

KÓD / ORDER CODE / BESTELL NR. / КОД		POPIS / DESCRIPTION / BESCHREIBUNG / ОПИСАНИЕ	OE / OE NUMBER / OE NUMBER / OE	NÁKRES / DRAWING / ZEICHNUNG / ЧЕРТЁЖ
724147 PRAVÁ / RIGHT / RECHTS / Правая		SUPERPOINT III. <ul style="list-style-type: none"> Červená + bílá + oranžová, kabel - 1,25 m Red + white + orange, cable - 1,25 m Rot + weiss + orange, kabel - 1,25 m Красная + Белая + оранжевая, Кабель -1,25 м 	31-3306-237	
724148 LEVÁ / LEFT / LINKS / Левая		SUPERPOINT III. <ul style="list-style-type: none"> Červená + bílá + oranžová, kabel - 1,25 m Red + white + orange, cable - 1,25 m Rot + weiss + orange, kabel - 1,25 m Красная + Белая + оранжевая, Кабель -1,25 м 	31-3305-237	
724123		SUPERPOINT III. <ul style="list-style-type: none"> Červená + bílá + oranžová, kabel - 1,25 m Red + white + orange, cable - 1,25 m Rot + weiss + orange, kabel - 1,25 m Красная + Белая + оранжевая, Кабель -1,25 м 	21-3351-707	
724203 PRAVÁ / RIGHT / RECHTS / Правая		SUPERPOINT IV. <ul style="list-style-type: none"> Červená + bílá + oranžová, kabel - 2 m Red + white + orange, cable - 2 m Rot + weiss + orange, kabel - 2 m Красная + Белая + Оранжевая, Кабель -2 м 	31-3104-017	
724204 LEVÁ / LEFT / LINKS / Левая		SUPERPOINT IV. <ul style="list-style-type: none"> Červená + bílá + oranžová, kabel - 2 m Red + white + orange, cable - 2 m Rot + weiss + orange, kabel - 2 m Красная + Белая + оранжевая, Кабель -2 м 	31-3104-007	
721468		<ul style="list-style-type: none"> P & R P & R Click P & R Klicken P & R 	4260089	

**OBRYSOVÁ SVĚTLA 24 V / OUTLINE MARKER LAMPS 24 V /
UMRISSLEUCHTEN 24 V / ГАБАРИТНЫЕ ЛАМПЫ 24 V**

KÓD / ORDER CODE / BESTELL NR. / КОД		POPIS / DESCRIPTION / BESCHREIBUNG / ОПИСАНИЕ	OE / OE NUMBER / OE NUMMER / OE	NÁKRES / DRAWING / ZEICHNUNG / ЧЕРТЁЖ
<p>720785 PRAVÁ / RIGHT / RECHTS / Правая</p>		<ul style="list-style-type: none"> ■ Červená + bílá + oranžová, kabel - 0,5 m ■ Red + white + orange, cable - 0,5 m ■ Rot + weiss + orange, kabel - 0,5 m ■ Красная + Белая + оранжевая, Кабель - 0,5 м 	<p>2XS011744-021</p>	
<p>720786 LEVÁ / LEFT / LINKS / Левая</p>		<ul style="list-style-type: none"> ■ Červená + bílá + oranžová, kabel - 0,5 m ■ Red + white + orange, cable - 0,5 m ■ Rot + weiss + orange, kabel - 0,5 m ■ Красная + Белая + оранжевая, Кабель - 0,5 м 	<p>2XS011744-011</p>	

**POZIČNÍ SVĚTLA 12-24 V / MARKER LAMPS 12-24 V /
POSITIONSLEUCHTEN 12-24 V / ГАБАРИТНЫЕ ЛАМПЫ 12-24 V**

KÓD / ORDER CODE / BESTELL NR. / КОД		POPIS / DESCRIPTION / BESCHREIBUNG / ОПИСАНИЕ	OE / OE NUMBER / OE NUMBER / OE	NÁKRES / DRAWING / ZEICHNUNG / ЧЕРТЁЖ
726993		MONOPOINT II. <ul style="list-style-type: none"> ■ Kabel - 3,5 m ■ Cable - 3,5 m ■ Kabel - 3,5 m ■ Кабель - 3,5 м 	31-6700-027	
723150		MONOPOINT II. <ul style="list-style-type: none"> ■ Kabel - 3,5 m ■ Cable - 3,5 m ■ Kabel - 3,5 m ■ Кабель - 3,5 м 	31-6700-037 31-6704-117	
721468		<ul style="list-style-type: none"> ■ P & R ■ P & R Click ■ P & R Klicken ■ P & R 	4260089	
KÓD / ORDER CODE / BESTELL NR. / КОД		POPIS / DESCRIPTION / BESCHREIBUNG / ОПИСАНИЕ	OE / OE NUMBER / OE NUMBER / OE	NÁKRES / DRAWING / ZEICHNUNG / ЧЕРТЁЖ
726966		POSIPOINT II. <ul style="list-style-type: none"> ■ Kabel - 0,5 m ■ Cable - 0,5 m ■ Kabel - 0,5 m ■ Кабель - 0,5 м 	31-7104-007	
726961		<ul style="list-style-type: none"> ■ Pouzdro ■ Housing ■ Gehäuse ■ Шайба 	15-5609-107	
721468		<ul style="list-style-type: none"> ■ P & R ■ P & R Click ■ P & R Klicken ■ P & R 	4260089	
KÓD / ORDER CODE / BESTELL NR. / КОД		POPIS / DESCRIPTION / BESCHREIBUNG / ОПИСАНИЕ	OE / OE NUMBER / OE NUMBER / OE	NÁKRES / DRAWING / ZEICHNUNG / ЧЕРТЁЖ
721656		<ul style="list-style-type: none"> ■ 1x LED, kabel - 0,2 m ■ 1x LED, cable - 0,2 m ■ 1x Leuchtdioden, kabel - 0,2 m ■ 1x Светодиодный, Кабель - 0,2 м 		

**POZIČNÍ SVĚTLA 12-24 V / MARKER LAMPS 12-24 V /
POSITIONSLEUCHTEN 12-24 V / ГАБАРИТНЫЕ ЛАМПЫ 12-24 V**

KÓD / ORDER CODE / BESTELL NR. / КОД		POPIS / DESCRIPTION / BESCHREIBUNG / ОПИСАНИЕ	OE / OE NUMBER / OE NUMMER / OE	NÁKRES / DRAWING / ZEICHNUNG / ЧЕРТЁЖ
724336		<ul style="list-style-type: none"> ■ 4x LED, kabel - 0,5 m ■ 4x LED, cable - 0,5 m ■ 4x Leuchtdioden, kabel - 0,5 m ■ 4x Светодиодный, Кабель - 0,5 м 		
721468		<ul style="list-style-type: none"> ■ P & R ■ P & R Click ■ P & R Klicken ■ P & R 	4260089	
KÓD / ORDER CODE / BESTELL NR. / КОД		POPIS / DESCRIPTION / BESCHREIBUNG / ОПИСАНИЕ	OE / OE NUMBER / OE NUMMER / OE	NÁKRES / DRAWING / ZEICHNUNG / ЧЕРТЁЖ
724320		<ul style="list-style-type: none"> ■ 2x LED, kabel - 0,5 m ■ 2x LED, cable - 0,5 m ■ 2x Leuchtdioden, kabel - 0,5 m ■ 2x Светодиодный, Кабель - 0,5 м 		
724318		<ul style="list-style-type: none"> ■ 2x LED, kabel - 4 m ■ 2x LED, cable - 4 m ■ 2x Leuchtdioden, kabel - 4 m ■ 2x Светодиодный, Кабель - 4 м 		
721468		<ul style="list-style-type: none"> ■ P & R ■ P & R Click ■ P & R Klicken ■ P & R 	4260089	
KÓD / ORDER CODE / BESTELL NR. / КОД		POPIS / DESCRIPTION / BESCHREIBUNG / ОПИСАНИЕ	OE / OE NUMBER / OE NUMMER / OE	NÁKRES / DRAWING / ZEICHNUNG / ЧЕРТЁЖ
721880		<ul style="list-style-type: none"> ■ 3x LED, kabel - 0,2 m ■ 3x LED, cable - 0,2 m ■ 3x Leuchtdioden, kabel - 0,2 m ■ 3x Светодиодный, Кабель - 0,2 м 		

**POZIČNÍ SVĚTLA 12-24 V / MARKER LAMPS 12-24 V /
POSITIONSLEUCHTEN 12-24 V / ГАБАРИТНЫЕ ЛАМПЫ 12-24 V**

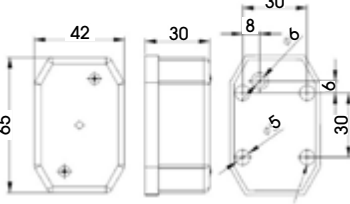
KÓD / ORDER CODE / BESTELL NR. / КОД		POPIS / DESCRIPTION / BESCHREIBUNG / ОПИСАНИЕ	OE / OE NUMBER / OE NUMBER / OE	NÁKRES / DRAWING / ZEICHNUNG / ЧЕРТЁЖ
721885		<ul style="list-style-type: none"> 1x LED, kabel - 0,2 m 1x LED, cable - 0,2 m 1x Leuchtdioden, kabel - 0,2 m 1x Светодиодный, Кабель - 0,2 м 		
724326		<ul style="list-style-type: none"> 4x LED, kabel - 0,5 m 4x LED, cable - 0,5 m 4x Leuchtdioden, kabel - 0,5 m 4x Светодиодный, Кабель - 0,5 м 		
724329		<ul style="list-style-type: none"> Držák Holder Halter держатель 		
724334		<ul style="list-style-type: none"> 3x LED, kabel - 0,5 m 3x LED, cable - 0,5 m 3x Leuchtdioden, kabel - 0,5 m 3x Светодиодный, Кабель - 0,5 м 		
721468		<ul style="list-style-type: none"> P & R P & R Click P & R Klicken P & R 	4260089	

**POZIČNÍ SVĚTLA 12-24 V / MARKER LAMPS 12-24 V /
POSITIONSLEUCHTEN 12-24 V / ГАБАРИТНЫЕ ЛАМПЫ 12-24 V**

KÓD / ORDER CODE / BESTELL NR. / КОД		POPIS / DESCRIPTION / BESCHREIBUNG / ОПИСАНИЕ	OE / OE NUMBER / OE NUMMER / OE	NÁKRES / DRAWING / ZEICHNUNG / ЧЕРТЁЖ
725997		<ul style="list-style-type: none"> ■ 4x LED, kabel - 0,5 m ■ 4x LED, cable - 0,5 m ■ 4x Leuchtdioden, kabel - 0,5 m ■ 4x Светодиодный, Кабель - 0,5 м 		
725970		<ul style="list-style-type: none"> ■ 4x LED, kabel - 0,5 m ■ 4x LED, cable - 0,5 m ■ 4x Leuchtdioden, kabel - 0,5 m ■ 4x Светодиодный, Кабель - 0,5 м 		
726009		<ul style="list-style-type: none"> ■ 3x LED, kabel - 0,95 m ■ 3x LED, cable - 0,95 m ■ 3x Leuchtdioden, kabel - 0,95 m ■ 3x Светодиодный, Кабель - 0,95 м 		
726010		<ul style="list-style-type: none"> ■ Držák ■ Holder ■ Halter ■ Держатель 		
721468		<ul style="list-style-type: none"> ■ P & R ■ P & R Click ■ P & R Klicken ■ P & R 	4260089	

**POZIČNÍ SVĚTLA 12-24 V / MARKER LAMPS 12-24 V /
POSITIONSLEUCHTEN 12-24 V / ГАБАРИТНЫЕ ЛАМПЫ 12-24 V**

KÓD / ORDER CODE / BESTELL NR. / КОД		POPIS / DESCRIPTION / BESCHREIBUNG / ОПИСАНИЕ	OE / OE NUMBER / OE NUMBER / OE	NÁKRES / DRAWING / ZEICHNUNG / ЧЕРТЁЖ
721881		<ul style="list-style-type: none"> 3x LED, kabel - 0,2 m 3x LED, cable - 0,2 m 3x Leuchtdioden, kabel - 0,2 m 3x Светодиодный, Кабель - 0,2 м 		
720563		<ul style="list-style-type: none"> 20x LED, kabel - 0,5 m 20x LED, cable - 0,5 m 20x Leuchtdioden, kabel - 0,5 m 20x Светодиодный, Кабель - 0,5 м 		
720544		<ul style="list-style-type: none"> 20x LED, kabel - 1,5 m 20x LED, cable - 1,5 m 20x Leuchtdioden, kabel - 1,5 m 20x Светодиодный, Кабель - 1,5 м 		
721468		<ul style="list-style-type: none"> P & R P & R Click P & R Klicken P & R 	4260089	
724335		<ul style="list-style-type: none"> 4x LED, kabel - 0,5 m 4x LED, cable - 0,5 m 4x Leuchtdioden, kabel - 0,5 m 4x Светодиодный, Кабель - 0,5 м 		
721805		<ul style="list-style-type: none"> 1x LED, kabel - 0,5 m 1x LED, cable - 0,5 m 1x Leuchtdioden, kabel - 0,5 m 1x Светодиодный, Кабель - 0,5 м 		





**POZIČNÍ SVĚTLA 12-24 V / MARKER LAMPS 12-24 V /
POSITIONSLEUCHTEN 12-24 V / ГАБАРИТНЫЕ ЛАМПЫ 12-24 V**

KÓD / ORDER CODE / BESTELL NR. / КОД		POPIS / DESCRIPTION / BESCHREIBUNG / ОПИСАНИЕ	OE / OE NUMBER / OE NUMBER / OE	NÁKRES / DRAWING / ZEICHNUNG / ЧЕРТЁЖ
725953		<ul style="list-style-type: none"> 4x LED, kabel - 0,5 m 4x LED, cable - 0,5 m 4x Leuchtdioden, kabel - 0,5m 4x Светодиодный, Кабель - 0,5 м 		
725911		<ul style="list-style-type: none"> 4x LED, kabel - 1,5 m 4x LED, cable - 1,5 m 4x Leuchtdioden, kabel - 1,5 m 4x Светодиодный, Кабель - 1,5 м 		
725952		<ul style="list-style-type: none"> 4x LED, kabel - 0,5 m 4x LED, cable - 0,5 m 4x Leuchtdioden, kabel - 0,5 m 4x Светодиодный, Кабель - 0,5 м 		
726010		<ul style="list-style-type: none"> Držák Holder Halter Держатель 		
721468		<ul style="list-style-type: none"> P & R P & R Click P & R Klicken P & R 	4260089	
KÓD / ORDER CODE / BESTELL NR. / КОД		POPIS / DESCRIPTION / BESCHREIBUNG / ОПИСАНИЕ	OE / OE NUMBER / OE NUMBER / OE	NÁKRES / DRAWING / ZEICHNUNG / ЧЕРТЁЖ
725954		<ul style="list-style-type: none"> 3x LED, kabel - 0,95 m 3x LED, cable - 0,95 m 3x Leuchtdioden, kabel - 0,95 m 3x Светодиодный, Кабель - 0,95 м 		
725979		<ul style="list-style-type: none"> 3x LED, kabel - 0,95 m 3x LED, cable - 0,95 m 3x Leuchtdioden, kabel - 0,95 m 3x Светодиодный, Кабель - 0,95 м 		

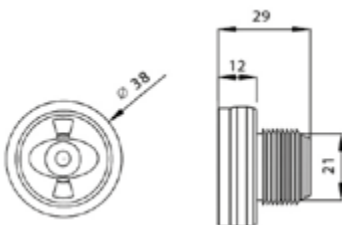

**POZIČNÍ SVĚTLA 12-24 V / MARKER LAMPS 12-24 V /
POSITIONSLEUCHTEN 12-24 V / ГАБАРИТНЫЕ ЛАМПЫ 12-24 V**

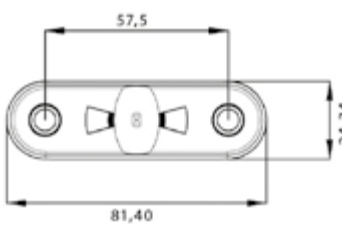
KÓD / ORDER CODE / BESTELL NR. / КОД		POPIS / DESCRIPTION / BESCHREIBUNG / ОПИСАНИЕ	OE / OE NUMBER / OE NUMMER / OE	NÁKRES / DRAWING / ZEICHNUNG / ЧЕРТЁЖ
725998		<ul style="list-style-type: none"> ■ 4x LED, kabel - 0,5 m ■ 4x LED, cable - 0,5 m ■ 4x Leuchtdioden, kabel - 0,5 m ■ 4x Светодиодный, Кабель - 0,5 м 		
726010		<ul style="list-style-type: none"> ■ Držák ■ Holder ■ Halter ■ Держатель 		
KÓD / ORDER CODE / BESTELL NR. / КОД		POPIS / DESCRIPTION / BESCHREIBUNG / ОПИСАНИЕ	OE / OE NUMBER / OE NUMMER / OE	NÁKRES / DRAWING / ZEICHNUNG / ЧЕРТЁЖ
724327		<ul style="list-style-type: none"> ■ 1x LED, kabel - 0,5 m ■ 1x LED, cable - 0,5 m ■ 1x Leuchtdioden, kabel - 0,5 m ■ 1x Светодиодный, Кабель - 0,5 м 		
724329		<ul style="list-style-type: none"> ■ Držák ■ Holder ■ Halter ■ Держатель 		
KÓD / ORDER CODE / BESTELL NR. / КОД		POPIS / DESCRIPTION / BESCHREIBUNG / ОПИСАНИЕ	OE / OE NUMBER / OE NUMMER / OE	NÁKRES / DRAWING / ZEICHNUNG / ЧЕРТЁЖ
721887		<ul style="list-style-type: none"> ■ 2x LED, kabel - 0,22 m ■ 2x LED, cable - 0,22 m ■ 2x Leuchtdioden, kabel - 0,22 m ■ 2x Светодиодный, Кабель - 0,22 м 		
721886		<ul style="list-style-type: none"> ■ 2x LED, kabel - 0,22 m ■ 2x LED, cable - 0,22 m ■ 2x Leuchtdioden, kabel - 0,22 m ■ 2x Светодиодный, Кабель - 0,22 м 		

**POZIČNÍ SVĚTLA 12-24 V / MARKER LAMPS 12-24 V /
POSITIONSLEUCHTEN 12-24 V / ГАБАРИТНЫЕ ЛАМПЫ 12-24 V**

KÓD / ORDER CODE / BESTELL NR. / КОД		POPIS / DESCRIPTION / BESCHREIBUNG / ОПИСАНИЕ	OE / OE NUMBER / OE NUMMER / OE	NÁKRES / DRAWING / ZEICHNUNG / ЧЕРТЁЖ
724021		MONOPOINT II. <ul style="list-style-type: none"> ■ Kabel - 3,5 m ■ Cable - 3,5 m ■ Kabel - 3,5 m ■ Кабель - 3,5 м 	31-6800-017	
726964		POSIPOINT II. <ul style="list-style-type: none"> ■ Kabel - 0,5 m ■ Cable - 0,5 m ■ Kabel - 0,5 m ■ Кабель - 0,5 м 	31-7204-007	
726961		<ul style="list-style-type: none"> ■ Pouzdro ■ Housing ■ ГЕИЃАУСЕ ■ Шайба 	15-5609-107	
721468		<ul style="list-style-type: none"> ■ P & R ■ P & R Click ■ P & R Klicken ■ P & R 	4260089	

**POZIČNÍ SVĚTLA 12-24 V / MARKER LAMPS 12-24 V /
POSITIONSLEUCHTEN 12-24 V / ГАБАРИТНЫЕ ЛАМПЫ 12-24 V**

KÓD / ORDER CODE / BESTELL NR. / КОД		POPIS / DESCRIPTION / BESCHREIBUNG / ОПИСАНИЕ	OE / OE NUMBER / OE NUMMER / OE	NÁKRES / DRAWING / ZEICHNUNG / ЧЕРТЁЖ
724321		<ul style="list-style-type: none"> 2x LED, kabel - 0,5 m 2x LED, cable - 0,5 m 2x Leuchtdioden, kabel - 0,5 m 2x Светодиодный, Кабель - 0,5 м 		
724311		<ul style="list-style-type: none"> 2x LED, kabel - 4 m 2x LED, cable - 4 m 2x Leuchtdioden, kabel - 4 m 2x Светодиодный, Кабель - 4 м 		
721468		<ul style="list-style-type: none"> P & R P & R Click P & R Klicken P & R 	4260089	
KÓD / ORDER CODE / BESTELL NR. / КОД		POPIS / DESCRIPTION / BESCHREIBUNG / ОПИСАНИЕ	OE / OE NUMBER / OE NUMMER / OE	NÁKRES / DRAWING / ZEICHNUNG / ЧЕРТЁЖ
721882		<ul style="list-style-type: none"> 3x LED, kabel - 0,2 m 3x LED, cable - 0,2 m 3x Leuchtdioden, kabel - 0,2 m 3x Светодиодный, Кабель - 0,2 м 		
KÓD / ORDER CODE / BESTELL NR. / КОД		POPIS / DESCRIPTION / BESCHREIBUNG / ОПИСАНИЕ	OE / OE NUMBER / OE NUMMER / OE	NÁKRES / DRAWING / ZEICHNUNG / ЧЕРТЁЖ
724328		<ul style="list-style-type: none"> 1x LED, kabel - 0,5 m 1x LED, cable - 0,5 m 1x Leuchtdioden, kabel - 0,5 m 1x Светодиодный, Кабель - 0,5 м 		





**POZIČNÍ SVĚTLA 12-24 V / MARKER LAMPS 12-24 V /
POSITIONSLEUCHTEN 12-24 V / ГАБАРИТНЫЕ ЛАМПЫ 12-24 V**

KÓD / ORDER CODE / BESTELL NR. / КОД		POPIS / DESCRIPTION / BESCHREIBUNG / ОПИСАНИЕ	OE / OE NUMBER / OE NUMMER / OE	NÁKRES / DRAWING / ZEICHNUNG / ЧЕРТЁЖ
726005		<ul style="list-style-type: none"> ■ 4x LED, kabel - 0,5 m ■ 4x LED, cable - 0,5 m ■ 4x Leuchtdioden, kabel - 0,5 m ■ 4x Светодиодный, Кабель - 0,5 м 		
726007		<ul style="list-style-type: none"> ■ 4x LED, kabel - 0,5 m ■ 4x LED, cable - 0,5 m ■ 4x Leuchtdioden, kabel - 0,5 m ■ 4x Светодиодный, Кабель - 0,5 м 		
726010		<ul style="list-style-type: none"> ■ Držák ■ Holder ■ Halter ■ Держатель 		
721468		<ul style="list-style-type: none"> ■ P & R ■ P & R Click ■ P & R Klicken ■ P & R 	4260089	
KÓD / ORDER CODE / BESTELL NR. / КОД		POPIS / DESCRIPTION / BESCHREIBUNG / ОПИСАНИЕ	OE / OE NUMBER / OE NUMMER / OE	NÁKRES / DRAWING / ZEICHNUNG / ЧЕРТЁЖ
725999		<ul style="list-style-type: none"> ■ 4x LED, kabel - 0,5 m ■ 4x LED, cable - 0,5 m ■ 4x Leuchtdioden, kabel - 0,5 m ■ 4x Светодиодный, Кабель - 0,5 м 		
KÓD / ORDER CODE / BESTELL NR. / КОД		POPIS / DESCRIPTION / BESCHREIBUNG / ОПИСАНИЕ	OE / OE NUMBER / OE NUMMER / OE	NÁKRES / DRAWING / ZEICHNUNG / ЧЕРТЁЖ
726006		<ul style="list-style-type: none"> ■ 3x LED, kabel - 0,95 m ■ 3x LED, cable - 0,95 m ■ 3x Leuchtdioden, kabel - 0,95 m ■ 3x Светодиодный, Кабель - 0,95 м 		



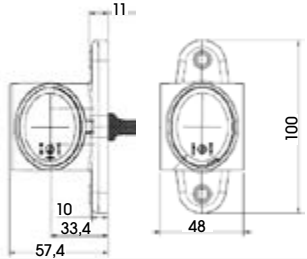

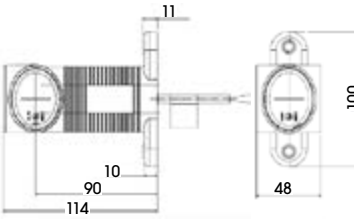

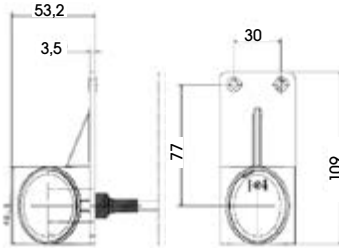

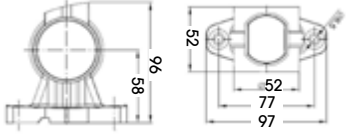

OBRYSOVÁ SVĚTLA 12-24 V / OUTLINE MARKER LAMPS 12-24 V / UMRISSELEUCHTEN 12-24 V / ГАБАРИТНЫЕ ЛАМПЫ 12-24 V

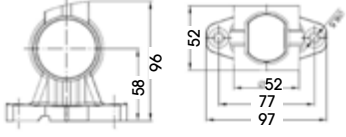
KÓD / ORDER CODE / BESTELL NR. / КОД		POPIS / DESCRIPTION / BESCHREIBUNG / ОПИСАНИЕ	OE / OE NUMBER / OE NUMBER / OE	NÁKRES / DRAWING / ZEICHNUNG / ЧЕРТЁЖ
721381		<ul style="list-style-type: none"> ■ Červená + bílá + oranžová, kabel - 0,2 m ■ Red + white + orange, cable - 0,2 m ■ Rot + weiss + orange, kabel - 0,2 m ■ Красная + Белая + Оранжевая, Кабель - 0,2 м 		
726725 PRAVÁ / RIGHT / RECHTS / Правая		<ul style="list-style-type: none"> ■ Červená + bílá + oranžová, kabel - 0,2 m ■ Red + white + orange, cable - 0,2 m ■ Rot + weiss + orange, kabel - 0,2 m ■ Красная + Белая + Оранжевая, Кабель - 0,2 м 		
726729 LEVÁ / LEFT / LINKS / Левая		<ul style="list-style-type: none"> ■ Červená + bílá + oranžová, kabel - 0,2 m ■ Red + white + orange, cable - 0,2 m ■ Rot + weiss + orange, kabel - 0,2 m ■ Красная + Белая + Оранжевая, Кабель - 0,2 м 		
726723 PRAVÁ / RIGHT / RECHTS / Правая		<ul style="list-style-type: none"> ■ Červená + bílá + oranžová, kabel - 0,2 m ■ Red + white + orange, cable - 0,2 m ■ Rot + weiss + orange, kabel - 0,2 m ■ Красная + Белая + Оранжевая, Кабель - 0,2 м 		
726724 LEVÁ / LEFT / LINKS / Левая		<ul style="list-style-type: none"> ■ Červená + bílá + oranžová, kabel - 0,2 m ■ Red + white + orange, cable - 0,2 m ■ Rot + weiss + orange, kabel - 0,2 m ■ Красная + Белая + Оранжевая, Кабель - 0,2 м 		

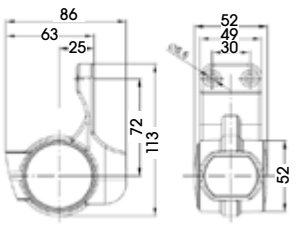
**OBRYSOVÁ SVĚTLA 12-24 V / OUTLINE MARKER LAMPS 12-24 V /
UMRISSLEUCHTEN 12-24 V / ГАБАРИТНЫЕ ЛАМПЫ 12-24 V**

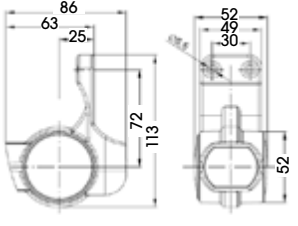
KÓD / ORDER CODE / BESTELL NR. / КОД		POPIS / DESCRIPTION / BESCHREIBUNG / ОПИСАНИЕ	OE / OE NUMBER / OE NUMMER / OE	NÁKRES / DRAWING / ZEICHNUNG / ЧЕРТЁЖ
721371		<ul style="list-style-type: none"> ■ Červená + bílá + oranžová, kabel - 1,7 m ■ Red + white + orange, cable - 1,7 m ■ Rot + weiss + orange, kabel - 1,7 m ■ Красная + Белая + Оранжевая, резиновый рукав, Кабель - 1,7 м 		
721370		<ul style="list-style-type: none"> ■ Červená + bílá + oranžová, kabel - 1,7 m ■ Red + white + orange, cable - 1,7 m ■ Rot + weiss + orange, kabel - 1,7 m ■ Красная + Белая + Оранжевая, резиновый рукав, Кабель - 1,7 м 		
721372		<ul style="list-style-type: none"> ■ Červená + bílá + oranžová, kabel - 1,7 m ■ Red + white + orange, cable - 1,7 m ■ Rot + weiss + orange, kabel - 1,7 m ■ Красная + Белая + Оранжевая, резиновый рукав, Кабель - 1,7 м 		

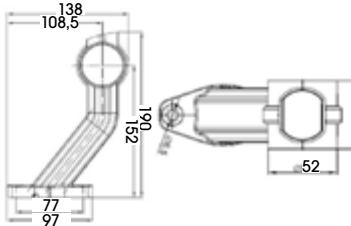
OBRYSOVÁ SVĚTLA 12-24 V / OUTLINE MARKER LAMPS 12-24 V / UMRISSELEUCHTEN 12-24 V / ГАБАРИТНЫЕ ЛАМПЫ 12-24 V

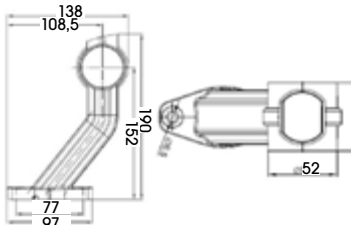
KÓD / ORDER CODE / BESTELL NR. / КОД		POPIS / DESCRIPTION / BESCHREIBUNG / ОПИСАНИЕ	OE / OE NUMBER / OE NUMBER / OE	NÁKRES / DRAWING / ZEICHNUNG / ЧЕРТЁК
721875 PRAVÁ / RIGHT / RECHTS / Правая		<ul style="list-style-type: none"> ■ Červená + bílá + oranžová, kabel - 0,5 m ■ Red + white + orange, cable - 0,5 m ■ Rot + weiss + orange, kabel - 0,5 m ■ Красная + Белая + Оранжевая, Кабель - 0,5 м 		
721876 LEVÁ / LEFT / LINKS / Левая		<ul style="list-style-type: none"> ■ Červená + bílá + oranžová, kabel - 0,5 m ■ Red + white + orange, cable - 0,5 m ■ Rot + weiss + orange, kabel - 0,5 m ■ Красная + Белая + Оранжевая, Кабель - 0,5 м 		
721826 PRAVÁ / RIGHT / RECHTS / Правая		<ul style="list-style-type: none"> ■ Červená + bílá + oranžová, kabel - 0,5 m ■ Red + white + orange, cable - 0,5 m ■ Rot + weiss + orange, kabel - 0,5 m ■ Красная + Белая + Оранжевая, Кабель - 0,5 м 		
721827 LEVÁ / LEFT / LINKS / Левая		<ul style="list-style-type: none"> ■ Červená + bílá + oranžová, kabel - 0,5 m ■ Red + white + orange, cable - 0,5 m ■ Rot + weiss + orange, kabel - 0,5 m ■ Красная + Белая + Оранжевая, Кабель - 0,5 м 		
721877 PRAVÁ / RIGHT / RECHTS / Правая		<ul style="list-style-type: none"> ■ Červená + bílá + oranžová, kabel - 0,5 m ■ Red + white + orange, cable - 0,5 m ■ Rot + weiss + orange, kabel - 0,5 m ■ Красная + Белая + Оранжевая, Кабель - 0,5 м 		
721878 LEVÁ / LEFT / LINKS / Левая		<ul style="list-style-type: none"> ■ Červená + bílá + oranžová, kabel - 0,5 m ■ Red + white + orange, cable - 0,5 m ■ Rot + weiss + orange, kabel - 0,5 m ■ Красная + Белая + Оранжевая, Кабель - 0,5 м 		









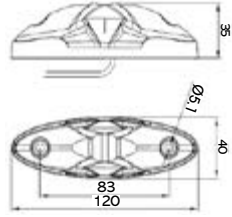

OBRYSOVÁ SVĚTLA 12-24 V / OUTLINE MARKER LAMPS 12-24 V / UMRISSLEUCHTEN 12-24 V / ГАБАРИТНЫЕ ЛАМПЫ 12-24 V

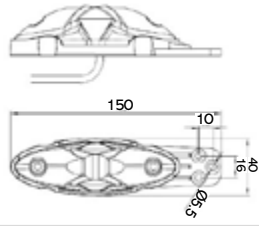
KÓD / ORDER CODE / BESTELL NR. / КОД		POPIS / DESCRIPTION / BESCHREIBUNG / ОПИСАНИЕ	OE / OE NUMBER / OE NUMBER / OE	NÁKRES / DRAWING / ZEICHNUNG / ЧЕРТЁЖ
721870		<ul style="list-style-type: none"> ■ Červená + čirá, kabel - 0,5 m ■ Red + clear, cable - 0,5 m ■ Rot + klar, kabel - 0,5 m ■ Красная + белая, Кабель - 0,5 м 		
721871		<ul style="list-style-type: none"> ■ Červená + čirá, kabel - 0,5 m ■ Red + clear, cable - 0,5 m ■ Rot + klar, kabel - 0,5 m ■ Красная + белая, Кабель - 0,5 м 		
721872		<ul style="list-style-type: none"> ■ Červená + čirá, kabel - 0,5 m ■ Red + clear, cable - 0,5 m ■ Rot + klar, kabel - 0,5 m ■ Красная + белая, Кабель - 0,5 м 		
721873		<ul style="list-style-type: none"> ■ Červená + čirá, kabel - 0,5 m ■ Red + clear, cable - 0,5 m ■ Rot + klar, kabel - 0,5 m ■ Красная + белая, Кабель - 0,5 м 		
721874		<ul style="list-style-type: none"> ■ Červená + čirá, kabel - 0,5 m ■ Red + clear, cable - 0,5 m ■ Rot + klar, kabel - 0,5 m ■ Красная + белая, Кабель - 0,5 м 		

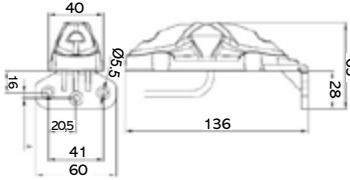
OBRYSOVÁ SVĚTLA 12-24 V / OUTLINE MARKER LAMPS 12-24 V / UMRISSLEUCHTEN 12-24 V / ГАБАРИТНЫЕ ЛАМПЫ 12-24 V

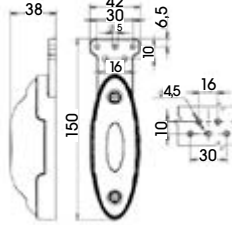
KÓD / ORDER CODE / BESTELL NR. / КОД		POPIS / DESCRIPTION / BESCHREIBUNG / ОПИСАНИЕ	OE / OE NUMBER / OE NUMBER / OE	NÁKRES / DRAWING / ZEICHNUNG / ЧЕРТЁЖ
722080		<ul style="list-style-type: none"> ■ Červená + čirá + oranžová, kabel - 1,7 m ■ Red + clear + orange, cable - 1,7 m ■ Rot + klar + orange, kabel - 1,7 m ■ Красная + белая + Оранжевая, Кабель - 1,7 м 		
722078 PRAVÁ / RIGHT / RECHTS / Правая		<ul style="list-style-type: none"> ■ Červená + čirá + oranžová, kabel - 1,7 m ■ Red + clear + orange, cable - 1,7 m ■ Rot + klar + orange, kabel - 1,7 m ■ Красная + белая + Оранжевая, Кабель - 1,7 м 		
722079 LEVÁ / LEFT / LINKS / Левая		<ul style="list-style-type: none"> ■ Červená + čirá + oranžová, kabel - 1,7 m ■ Red + clear + orange, cable - 1,7 m ■ Rot + klar + orange, kabel - 1,7 m ■ Красная + белая + Оранжевая, Кабель - 1,7 м 		

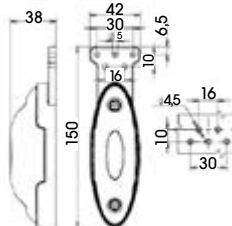
OBRYSOVÁ SVĚTLA 12-24 V / OUTLINE MARKER LAMPS 12-24 V / UMRISSLEUCHTEN 12-24 V / ГАБАРИТНЫЕ ЛАМПЫ 12-24 V

KÓD / ORDER CODE / BESTELL NR. / КОД		POPIS / DESCRIPTION / BESCHREIBUNG / ОПИСАНИЕ	OE / OE NUMBER / OE NUMMER / OE	NÁKRES / DRAWING / ZEICHNUNG / ЧЕРТЁЖ
721564		<ul style="list-style-type: none"> Červená + čirá + oranžová, kabel P & R - 0,5 m Red + clear + orange, cable P & R - 0,5 m Rot + klar + orange, kabel P & R - 0,5 m Красная + белая + Оранжевая, Кабель P & R - 0,5 м 		
721562		<ul style="list-style-type: none"> Červená + čirá + oranžová, kabel P & R - 0,5 m Red + clear + orange, cable P & R - 0,5 m Rot + klar + orange, kabel P & R - 0,5 m Красная + белая + Оранжевая, Кабель P & R - 0,5 м 		
721563		<ul style="list-style-type: none"> Červená + čirá + oranžová, kabel P & R - 0,5 m Red + clear + orange, cable P & R - 0,5 m Rot + klar + orange, kabel P & R - 0,5 m Красная + белая + Оранжевая, Кабель P & R - 0,5 м 		
721468		<ul style="list-style-type: none"> P & R P & R Click P & R Klicken P & R 	4260089	
KÓD / ORDER CODE / BESTELL NR. / КОД		POPIS / DESCRIPTION / BESCHREIBUNG / ОПИСАНИЕ	OE / OE NUMBER / OE NUMMER / OE	NÁKRES / DRAWING / ZEICHNUNG / ЧЕРТЁЖ
721632 PRAVÁ / RIGHT / RECHTS / Правая		<ul style="list-style-type: none"> Červená + čirá + oranžová, kabel - 0,35 m Red + clear + orange, cable - 0,35 m Rot + klar + orange, kabel - 0,35 m Красная + белая + Оранжевая, Кабель - 0,35 м 		
721633 LEVÁ / LEFT / LINKS / Левая		<ul style="list-style-type: none"> Červená + čirá + oranžová, kabel - 0,35 m Red + clear + orange, cable - 0,35 m Rot + klar + orange, kabel - 0,35 m Красная + белая + Оранжевая, Кабель - 0,35 м 		
721468		<ul style="list-style-type: none"> P & R P & R Click P & R Klicken P & R 	4260089	



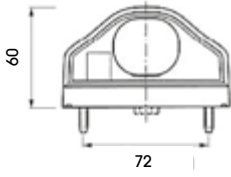

OBRYSOVÁ SVĚTLA 12-24 V / OUTLINE MARKER LAMPS 12-24 V / UMRISSELEUCHTEN 12-24 V / ГАБАРИТНЫЕ ЛАМПЫ 12-24 V

KÓD / ORDER CODE / BESTELL NR. / КОД		POPIS / DESCRIPTION / BESCHREIBUNG / ОПИСАНИЕ	OE / OE NUMBER / OE NUMBER / OE	NÁKRES / DRAWING / ZEICHNUNG / ЧЕРТЁЖ
721389		<ul style="list-style-type: none"> Červená + bílá, kabel - 0,2 m Red + white, cable - 0,2 m Rot + weiss, kabel - 0,2 m Красная + Белая, Кабель - 0,2 м 		
721391		<ul style="list-style-type: none"> Červená + bílá, kabel P & R - 0,2 m, Red + white, cable P & R - 0,2 m Rot + weiss, kabel P & R - 0,2 m Красная + Белая, Кабель P & R - 0,2 м 		
721468		<ul style="list-style-type: none"> P & R P & R Click P & R Klicken P & R 		
KÓD / ORDER CODE / BESTELL NR. / КОД		POPIS / DESCRIPTION / BESCHREIBUNG / ОПИСАНИЕ	OE / OE NUMBER / OE NUMBER / OE	NÁKRES / DRAWING / ZEICHNUNG / ЧЕРТЁЖ
721653		<ul style="list-style-type: none"> Červená + čirá, kabel - 0,35 m Red + clear, cable - 0,35 m Rot + klar, kabel - 0,35 m Красная + белая, Кабель - 0,35 м 		
721651		<ul style="list-style-type: none"> Červená + čirá, kabel P & R - 1,5 m Red + clear, cable P & R - 1,5 m Rot + klar, kabel P & R - 1,5 m Красная + белая, Кабель P & R - 1,5 м 		
721468		<ul style="list-style-type: none"> P & R P & R Click P & R Klicken P & R 	4260089	
KÓD / ORDER CODE / BESTELL NR. / КОД		POPIS / DESCRIPTION / BESCHREIBUNG / ОПИСАНИЕ	OE / OE NUMBER / OE NUMBER / OE	NÁKRES / DRAWING / ZEICHNUNG / ЧЕРТЁЖ
721427		<ul style="list-style-type: none"> Červená + čirá, kabel P & R - 1,5 m Red + clear, cable P & R - 1,5 m Rot + klar, kabel P & R - 1,5 m Красная + белая, Кабель P & R - 1,5 м 		
721468		<ul style="list-style-type: none"> P & R P & R Click P & R Klicken P & R 	4260089	

OSVĚTLENÍ SPZ / ILLUMINATION FOR NUMBERPLATE / KENNZEICHENLEUCHTE / ФОНАРЬ ПОДСВЕТКИ НОМЕРНОГО ЗНАКА

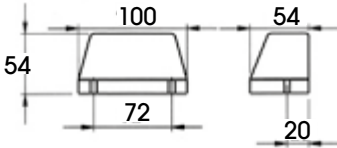

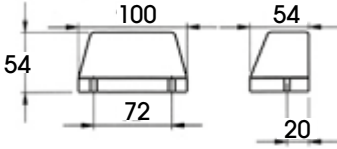

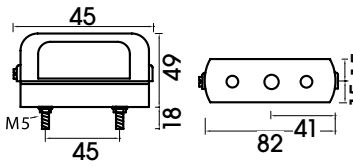



KÓD / ORDER CODE / BESTELL NR. / КОД		POPIS / DESCRIPTION / BESCHREIBUNG / ОПИСАНИЕ	OE / OE NUMBER / OE NUMBER / OE	NÁKRES / DRAWING / ZEICHNUNG / ЧЕРТЁЖ						
724206			196020							
				<table border="1"> <tr> <td>722940</td> <td>12V</td> <td>R5W 12V, BA15s</td> </tr> <tr> <td>722941</td> <td>24V</td> <td>R5W 24V, BA15s</td> </tr> </table>	722940	12V	R5W 12V, BA15s	722941	24V	R5W 24V, BA15s
722940	12V	R5W 12V, BA15s								
722941	24V	R5W 24V, BA15s								
724195			26-3010-004							
				<table border="1"> <tr> <td>722950</td> <td>12V</td> <td>C5W 12V, SV8,5-8</td> </tr> <tr> <td>722951</td> <td>24V</td> <td>C5W 24V, SV8,5-8</td> </tr> </table>	722950	12V	C5W 12V, SV8,5-8	722951	24V	C5W 24V, SV8,5-8
722950	12V	C5W 12V, SV8,5-8								
722951	24V	C5W 24V, SV8,5-8								
727013			610091							
				<table border="1"> <tr> <td>722950</td> <td>12V</td> <td>C5W 12V, SV8,5-8</td> </tr> <tr> <td>722951</td> <td>24V</td> <td>C5W 24V, SV8,5-8</td> </tr> </table>	722950	12V	C5W 12V, SV8,5-8	722951	24V	C5W 24V, SV8,5-8
722950	12V	C5W 12V, SV8,5-8								
722951	24V	C5W 24V, SV8,5-8								

OSVĚTLENÍ SPZ / ILLUMINATION FOR NUMBERPLATE / KENNZEICHENLEUCHTE / ФОНАРЬ ПОДСВЕТКИ НОМЕРНОГО ЗНАКА

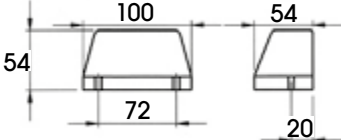

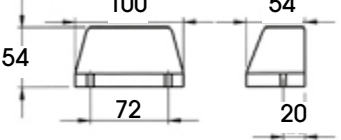

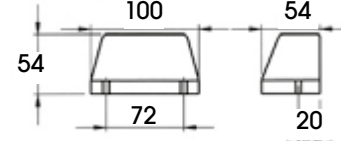

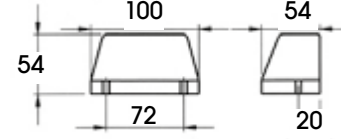





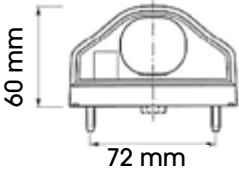

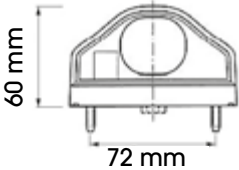
KÓD / ORDER CODE / BESTELL NR. / КОД		POPIS / DESCRIPTION / BESCHREIBUNG / ОПИСАНИЕ	OE / OE NUMBER / OE NUMBER / OE	NÁKRES / DRAWING / ZEICHNUNG / ЧЕРТЁЖ						
721908										
				<table border="1"> <tr> <td>722940</td> <td>12V</td> <td>R5W 12V, BA15s</td> </tr> <tr> <td>722941</td> <td>24V</td> <td>R5W 24V, BA15s</td> </tr> </table>	722940	12V	R5W 12V, BA15s	722941	24V	R5W 24V, BA15s
722940	12V	R5W 12V, BA15s								
722941	24V	R5W 24V, BA15s								
721909										
				<table border="1"> <tr> <td>722940</td> <td>12V</td> <td>R5W 12V, BA15s</td> </tr> <tr> <td>722941</td> <td>24V</td> <td>R5W 24V, BA15s</td> </tr> </table>	722940	12V	R5W 12V, BA15s	722941	24V	R5W 24V, BA15s
722940	12V	R5W 12V, BA15s								
722941	24V	R5W 24V, BA15s								
721945										
				<table border="1"> <tr> <td>722950</td> <td>12V</td> <td>C5W 12V, SV8,5-8</td> </tr> <tr> <td>722951</td> <td>24V</td> <td>C5W 24V, SV8,5-8</td> </tr> </table>	722950	12V	C5W 12V, SV8,5-8	722951	24V	C5W 24V, SV8,5-8
722950	12V	C5W 12V, SV8,5-8								
722951	24V	C5W 24V, SV8,5-8								
727348										
				<table border="1"> <tr> <td>722950</td> <td>12V</td> <td>C5W 12V, SV8,5-8</td> </tr> <tr> <td>722951</td> <td>24V</td> <td>C5W 24V, SV8,5-8</td> </tr> </table>	722950	12V	C5W 12V, SV8,5-8	722951	24V	C5W 24V, SV8,5-8
722950	12V	C5W 12V, SV8,5-8								
722951	24V	C5W 24V, SV8,5-8								

Important notice: part of other producers are only mentioned for comparison purposes.

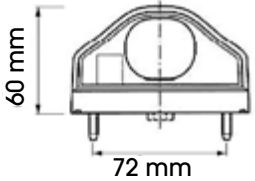
OSVĚTLENÍ SPZ / ILLUMINATION FOR NUMBERPLATE / KENNZEICHENLEUCHE / ФОНАРЬ ПОДСВЕТКИ НОМЕРНОГО ЗНАКА

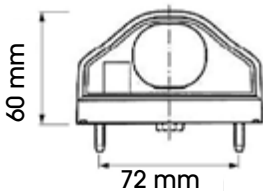
KÓD / ORDER CODE / BESTELL NR. / КОД		POPIS / DESCRIPTION / BESCHREIBUNG / ОПИСАНИЕ	OE / OE NUMBER / OE NUMBER / OE	NÁKRES / DRAWING / ZEICHNUNG / ЧЕРТЁЖ
727297				
723051				
726541				
727296				

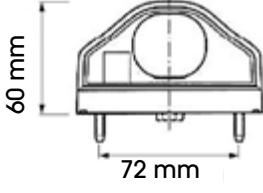
OSVĚTLENÍ SPZ / ILLUMINATION FOR NUMBERPLATE / KENNZEICHENLEUCHTE / ФОНАРЬ ПОДСВЕТКИ НОМЕРНОГО ЗНАКА

KÓD / ORDER CODE / BESTELL NR. / КОД		POPIS / DESCRIPTION / BESCHREIBUNG / ОПИСАНИЕ	OE / OE NUMBER / OE NUMBER / OE	NÁKRES / DRAWING / ZEICHNUNG / ЧЕРТЁЖ
724194		REGPOINT <ul style="list-style-type: none"> ■ Kabel – 0,5 m ■ Cable – 0,5 m ■ Kabel – 0,5 m ■ Кабель – 0,5 м 	 36-3604-007	
724194/N		<ul style="list-style-type: none"> ■ Kabel – 0,5 m ■ Cable – 0,5 m ■ Kabel – 0,5 m ■ Кабель – 0,5 м 	 36-3604-007	
721468		<ul style="list-style-type: none"> ■ P & R ■ P & R Click ■ P & R Klicken ■ P & R 	4260089	
KÓD / ORDER CODE / BESTELL NR. / КОД		POPIS / DESCRIPTION / BESCHREIBUNG / ОПИСАНИЕ	OE / OE NUMBER / OE NUMBER / OE	NÁKRES / DRAWING / ZEICHNUNG / ЧЕРТЁЖ
720830		<ul style="list-style-type: none"> ■ Kabel – 0,17 m ■ Cable – 0,17 m ■ Kabel – 0,17 m ■ Кабель – 0,17 м 	 36-3604-007	
KÓD / ORDER CODE / BESTELL NR. / КОД		POPIS / DESCRIPTION / BESCHREIBUNG / ОПИСАНИЕ	OE / OE NUMBER / OE NUMBER / OE	NÁKRES / DRAWING / ZEICHNUNG / ЧЕРТЁЖ
723052		<ul style="list-style-type: none"> ■ Kabel – 0,17 m ■ Cable – 0,17 m ■ Kabel – 0,17 m ■ Кабель – 0,17 м 		
723049		<ul style="list-style-type: none"> ■ Kabel – 0,5 m ■ Cable – 0,5 m ■ Kabel – 0,5 m ■ Кабель – 0,5 м 		
721468		<ul style="list-style-type: none"> ■ P & R ■ P & R Click ■ P & R Klicken ■ P & R 		

Important notice: part of other producers are only mentioned for comparison purposes.

**REFLEXNÍ TABULE /
REAR MARKER BOARDS /
WARNTAFEL SET /
СВЕТООТРАЖАЮЩИЕ ТАБЛИЦЫ**

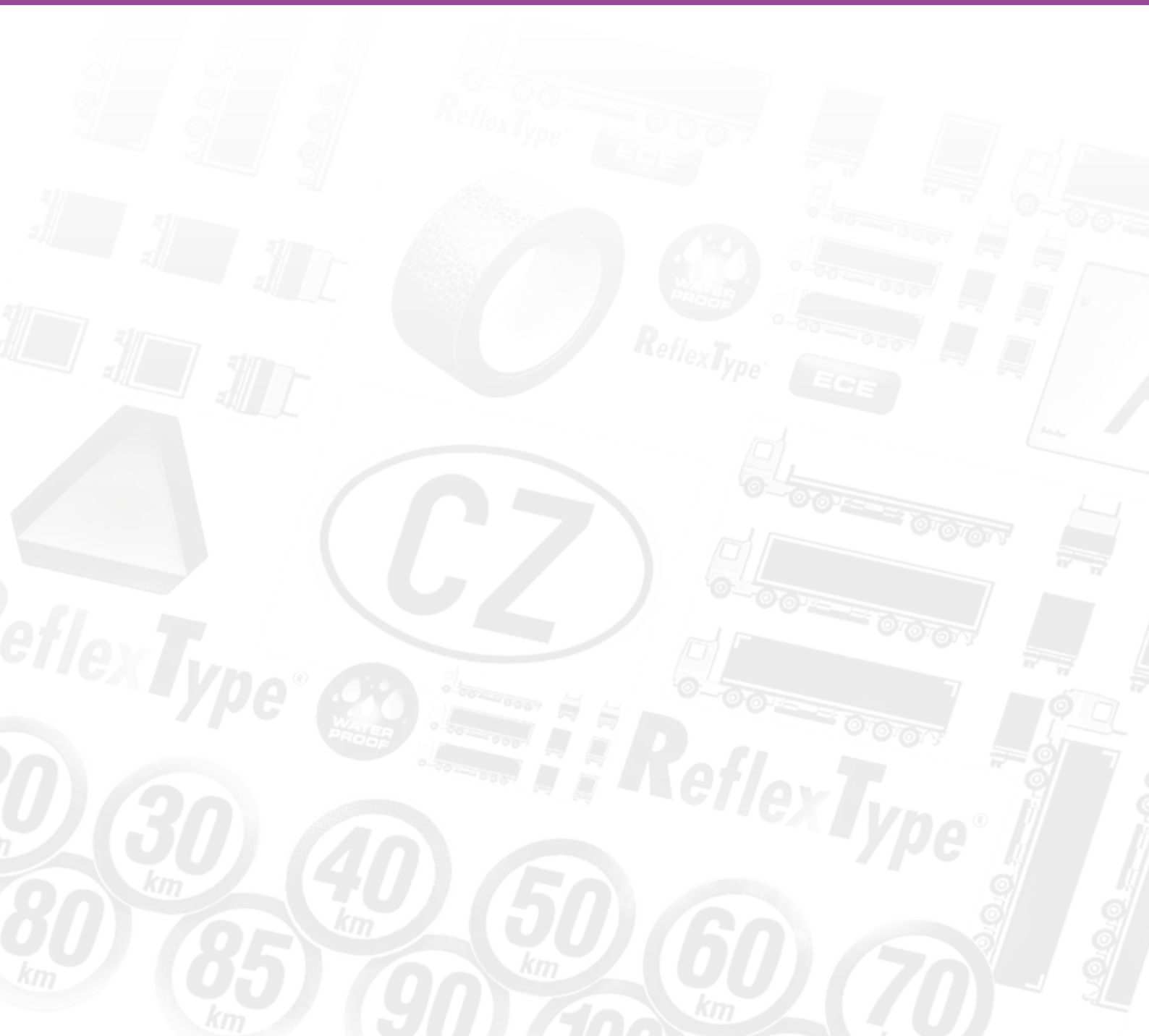

REFLEXNÍ TABULE / REAR MARKER BOARDS/ WARNTAFEL SET / СВЕТООТРАЖАЮЩИЕ ТАБЛИЦЫ



ReflexType[®]

ECE

KÓD / ORDER CODE / BESTELL NR. / КОД	MATERIÁL / MATERIAL / MATERIAL / МАТЕРИАЛ	PÁR / PAIR / PAAR / ПАРА	KS / PCS / STÜCK / ЧАСТЬ	OE / OE NUMBER / OE NUMMER / OE	ROZMĚR / DIMENSION / DIMENSION / РАЗМЕРНОСТЬ
720385	■ hliník, aluminium, aluminium, алюминий	■			138x566 mm
720391	■ samolepka, sticker, aufkleber, наклейка	■			138x566 mm



ReflexType[®]

ECE

KÓD / ORDER CODE / BESTELL NR. / КОД	MATERIÁL / MATERIAL / MATERIAL / МАТЕРИАЛ	PÁR / PAIR / PAAR / ПАРА	KS / PCS / STÜCK / ЧАСТЬ	OE / OE NUMBER / OE NUMMER / OE	ROZMĚR / DIMENSION / DIMENSION / РАЗМЕРНОСТЬ
720388	■ hliník, aluminium, aluminium, алюминий	■			197x566 mm
720392	■ samolepka, sticker, aufkleber, наклейка	■			197x566 mm



ReflexType[®]

ECE

KÓD / ORDER CODE / BESTELL NR. / КОД	MATERIÁL / MATERIAL / MATERIAL / МАТЕРИАЛ	PÁR / PAIR / PAAR / ПАРА	KS / PCS / STÜCK / ЧАСТЬ	OE / OE NUMBER / OE NUMMER / OE	ROZMĚR / DIMENSION / DIMENSION / РАЗМЕРНОСТЬ
720389	■ hliník, aluminium, aluminium, алюминий		■		197x1132 mm
720381	■ samolepka, sticker, aufkleber, наклейка		■		197x1132 mm



ReflexType[®]

ECE

KÓD / ORDER CODE / BESTELL NR. / КОД	MATERIÁL / MATERIAL / MATERIAL / МАТЕРИАЛ	PÁR / PAIR / PAAR / ПАРА	KS / PCS / STÜCK / ЧАСТЬ	OE / OE NUMBER / OE NUMMER / OE	ROZMĚR / DIMENSION / DIMENSION / РАЗМЕРНОСТЬ
720387	■ hliník, aluminium, aluminium, алюминий		■		132x1132 mm

Important notice: part of other producers are only mentioned for comparison purposes.

REFLEXNÍ TABULE / REAR MARKER BOARDS/ WARNTAFEL SET / СВЕТООТРАЖАЮЩИЕ ТАБЛИЦЫ



ReflexType®



KÓD / ORDER CODE / BESTELL NR. / КОД	MATERIÁL / MATERIAL / MATERIAL / МАТЕРИАЛ	PÁR / PAIR / PAAR / ПАРА	KS / PCS / STÜCK / ЧАСТЬ	OE / OE NUMBER / OE NUMBER / OE	ROZMĚR / DIMENSION / DIMENSION / РАЗМЕРНОСТЬ
723728	<ul style="list-style-type: none"> ■ hliník, reflexní ■ aluminium, reflective ■ aluminium, reflektierende ■ алюминий, рефлекс 		■		

Holder / держатель / Halter / Držák

723731					
723730					



ReflexType®



KÓD / ORDER CODE / BESTELL NR. / КОД	MATERIÁL / MATERIAL / MATERIAL / МАТЕРИАЛ	PÁR / PAIR / PAAR / ПАРА	KS / PCS / STÜCK / ЧАСТЬ	OE / OE NUMBER / OE NUMBER / OE	ROZMĚR / DIMENSION / DIMENSION / РАЗМЕРНОСТЬ
723726	<ul style="list-style-type: none"> ■ samolepka, reflexní ■ sticker, reflective ■ aufkleber, reflektierende ■ наклейка, рефлекс 		■		

TABULE „A“ / BOARD „A“ /
WARNTAFEL „A“ / ДОСКА СО ЗНАКОМ „A“

ReflexType®



KÓD / ORDER CODE / BESTELL NR. / КОД	MATERIÁL / MATERIAL / MATERIAL / МАТЕРИАЛ	PÁR / PAIR / PAAR / ПАРА	KS / PCS / STÜCK / ЧАСТЬ	OE / OE NUMBER / OE NUMMER / OE	ROZMĚR / DIMENSION / DIMENSION / РАЗМЕРНОСТЬ
723754	<ul style="list-style-type: none"> ■ Reflexní s gumou ■ Reflective with rubber ■ Reflektierende mit gummi ■ Рефлекс с резиной 		■		400x300 mm

ReflexType®



KÓD / ORDER CODE / BESTELL NR. / КОД	MATERIÁL / MATERIAL / MATERIAL / МАТЕРИАЛ	PÁR / PAIR / PAAR / ПАРА	KS / PCS / STÜCK / ЧАСТЬ	OE / OE NUMBER / OE NUMMER / OE	ROZMĚR / DIMENSION / DIMENSION / РАЗМЕРНОСТЬ
723753	<ul style="list-style-type: none"> ■ Reflexní s gumou, sklopná ■ Reflective with rubber, folding ■ Reflektierende mit gummi, klapp ■ Рефлекс с резиной, складной 		■		400x300 mm

ReflexType®



KÓD / ORDER CODE / BESTELL NR. / КОД	MATERIÁL / MATERIAL / MATERIAL / МАТЕРИАЛ	PÁR / PAIR / PAAR / ПАРА	KS / PCS / STÜCK / ЧАСТЬ	OE / OE NUMBER / OE NUMMER / OE	ROZMĚR / DIMENSION / DIMENSION / РАЗМЕРНОСТЬ
723752	<ul style="list-style-type: none"> ■ Samolepící / adhesive / selbstklebend / наклейка 		■		400x300 mm
723749	<ul style="list-style-type: none"> ■ Samolepící, reflexní / adhesive, reflective / selbstklebend, reflektierende / наклейка, рефлекс / 		■		400x300 mm
723755	<ul style="list-style-type: none"> ■ Magnetická reflexní / magnetic, reflective / magnetisch, reflektierende / магнитные, рефлекс 		■		400x300 mm

Important notice: part of other producers are only mentioned for comparison purposes.



ReflexType®

KÓD / ORDER CODE / BESTELL NR. / КОД	MATERIÁL / MATERIAL / MATERIAL / МАТЕРИАЛ	PÁR / PAIR / PAAR / ПАРА	KS / PCS / STÜCK / ЧАСТЬ	OE / OE NUMBER / OE NUMBER / OE	ROZMĚR / DIMENSION / DIMENSION / РАЗМЕРНОСТЬ
723803	<ul style="list-style-type: none"> ▪ hliník ▪ aluminium ▪ aluminium ▪ алюминий 		■		400x300 mm

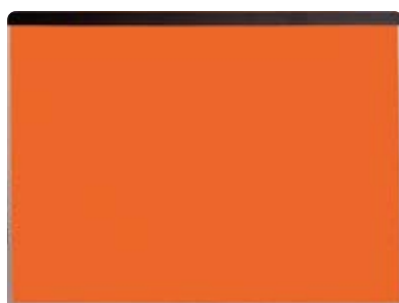

ReflexType®

Držák / Holder / Halter / держатель

723805



KÓD / ORDER CODE / BESTELL NR. / КОД	MATERIÁL / MATERIAL / MATERIAL / МАТЕРИАЛ	PÁR / PAIR / PAAR / ПАРА	KS / PCS / STÜCK / ЧАСТЬ	OE / OE NUMBER / OE NUMBER / OE	ROZMĚR / DIMENSION / DIMENSION / РАЗМЕРНОСТЬ
723804	<ul style="list-style-type: none"> ▪ hliník, uchycení na držák ▪ aluminium, mounting on holder ▪ aluminium, montage an der halterung ▪ Алюминий, крепление на держателе 		■		400x300 mm



ReflexType®

KÓD / ORDER CODE / BESTELL NR. / КОД	MATERIÁL / MATERIAL / MATERIAL / МАТЕРИАЛ	PÁR / PAIR / PAAR / ПАРА	KS / PCS / STÜCK / ЧАСТЬ	OE / OE NUMBER / OE NUMBER / OE	ROZMĚR / DIMENSION / DIMENSION / РАЗМЕРНОСТЬ
723833	<ul style="list-style-type: none"> ▪ hliník, sklopná s gumou ▪ aluminium, folding with rubber ▪ aluminium, klapp mit Gummi ▪ алюминий, складывающиеся с резиной 		■		400x300 mm



Držák / Holder / Halter / держатель		
723805		

KÓD / ORDER CODE / BESTELL NR. / КОД	MATERIÁL / MATERIAL / MATERIAL / МАТЕРИАЛ	PÁR / PAIR / PAAR / ПАРА	KS / PCS / STÜCK / ЧАСТЬ	OE / OE NUMBER / OE NUMMER / OE	ROZMĚR / DIMENSION / DIMENSION / РАЗМЕРНОСТЬ
723809	<ul style="list-style-type: none"> hliník, uchycení na držák, označení pro převoz benzínu aluminium, mounting on holder, designation for transporting petrol aluminium, montage an der halterung, bezeichnung für den transport vonbenzin алюминий, крепление на держателе, Обозначение для транспортировки бензина 		■		400x300 mm



Držák / Holder / Halter / держатель		
723805		

KÓD / ORDER CODE / BESTELL NR. / КОД	MATERIÁL / MATERIAL / MATERIAL / МАТЕРИАЛ	PÁR / PAIR / PAAR / ПАРА	KS / PCS / STÜCK / ЧАСТЬ	OE / OE NUMBER / OE NUMMER / OE	ROZMĚR / DIMENSION / DIMENSION / РАЗМЕРНОСТЬ
723807	<ul style="list-style-type: none"> hliník, uchycení na držák, označení pro převoz nafty aluminium, mounting on holder, designation for transporting diesel aluminium, montage an der halterung, bezeichnung für den transport von diesel алюминий, крепление на держателе, Обозначение для транспортировки дизельного топлива 		■		400x300 mm



KÓD / ORDER CODE / BESTELL NR. / КОД	MATERIÁL / MATERIAL / MATERIAL / МАТЕРИАЛ	PÁR / PAIR / PAAR / ПАРА	KS / PCS / STÜCK / ЧАСТЬ	OE / OE NUMBER / OE NUMMER / OE	ROZMĚR / DIMENSION / DIMENSION / РАЗМЕРНОСТЬ
723810	<ul style="list-style-type: none"> hliník, sklopná, označení pro převoz benzínu aluminium, folding, designation for transporting petrol aluminium, klapp, bezeichnung für den transport von benzin алюминий, складывающиеся, обозначение для транспортировки бензина 		■		400x300 mm



KÓD / ORDER CODE / BESTELL NR. / КОД	MATERIÁL / MATERIAL / MATERIAL / МАТЕРИАЛ	PÁR / PAIR / PAAR / ПАРА	KS / PCS / STÜCK / ЧАСТЬ	OE / OE NUMBER / OE NUMBER / OE	ROZMĚR / DIMENSION / DIMENSION / РАЗМЕРНОСТЬ
723808	<ul style="list-style-type: none"> ▪ hliník, sklopná, označení pro převoz nafty ▪ aluminium, folding, designation for transporting diesel ▪ aluminium, klapp, bezeichnung für den transport von diesel ▪ алюминий, складывающиеся, Обозначение для транспортировки дизельного топлива 		▪		400x300 mm



KÓD / ORDER CODE / BESTELL NR. / КОД	MATERIÁL / MATERIAL / MATERIAL / МАТЕРИАЛ	PÁR / PAIR / PAAR / ПАРА	KS / PCS / STÜCK / ЧАСТЬ	OE / OE NUMBER / OE NUMBER / OE	ROZMĚR / DIMENSION / DIMENSION / РАЗМЕРНОСТЬ
723811	<ul style="list-style-type: none"> ▪ hliník, měnitelná: 30/1202 (nafta) a 33/1203 (benzin) ▪ aluminium, changeable: 30/1202 (diesel) a 33/1203 (petrol) ▪ aluminium, wechselbar: 30/1202 (diesel) a 33/1203 (benzin) ▪ алюминий, изменчивый: 30/1202 (дизельного топлива) a 33/1203 (бензина) 		▪		400x300 mm



Držák / Holder / Halter / держатель		
723801		

KÓD / ORDER CODE / BESTELL NR. / КОД	MATERIÁL / MATERIAL / MATERIAL / МАТЕРИАЛ	PÁR / PAIR / PAAR / ПАРА	KS / PCS / STÜCK / ЧАСТЬ	OE / OE NUMBER / OE NUMMER / OE	ROZMĚR / DIMENSION / DIMENSION / РАЗМЕРНОСТЬ
723800	<ul style="list-style-type: none"> ▪ hliník ▪ aluminium ▪ aluminium ▪ алюминий 		▪		300x120 mm



KÓD / ORDER CODE / BESTELL NR. / КОД	MATERIÁL / MATERIAL / MATERIAL / МАТЕРИАЛ	PÁR / PAIR / PAAR / ПАРА	KS / PCS / STÜCK / ЧАСТЬ	OE / OE NUMBER / OE NUMMER / OE	ROZMĚR / DIMENSION / DIMENSION / РАЗМЕРНОСТЬ
723802	<ul style="list-style-type: none"> ▪ hliník, sklopná ▪ aluminium, folding ▪ aluminium, klapp ▪ алюминий, складывающиеся 		▪		300x120 mm



ReflexType®

KÓD / ORDER CODE / BESTELL NR. / КОД	MATERIÁL / MATERIAL / MATERIAL / МАТЕРИАЛ	PÁR / PAIR / PAAR / ПАРА	KS / PCS / STŮCK / ЧАСТЬ	OE / OE NUMBER / OE NUMBER / OE	ROZMĚR / DIMENSION / DIMENSION / РАЗМЕРНОСТЬ
723812	<ul style="list-style-type: none"> ■ hliník, nosič čísel ■ aluminium, holder numbers ■ aluminium, zahl halter ■ алюминий, держатель чисел 		■		400x300 mm



ReflexType®

KÓD / ORDER CODE / BESTELL NR. / КОД	MATERIÁL / MATERIAL / MATERIAL / МАТЕРИАЛ	PÁR / PAIR / PAAR / ПАРА	KS / PCS / STŮCK / ЧАСТЬ	OE / OE NUMBER / OE NUMBER / OE	ROZMĚR / DIMENSION / DIMENSION / РАЗМЕРНОСТЬ
723813	<ul style="list-style-type: none"> ■ hliník, nosič čísel, sklopná ■ aluminium, holder numbers, folding ■ aluminium, zahl halter, klapp ■ алюминий, держатель чисел, складывающиеся 		■		400x300 mm

723820	0	723824	4	723828	8
723821	1	723825	5	723829	9
723822	2	723826	6	723830	■
723823	3	723827	7	723831	X

ReflexType®



KÓD / ORDER CODE / BESTELL NR. / КОД	MATERIÁL / MATERIAL / MATERIAL / МАТЕРИАЛ	PÁR / PAIR / PAAR / ПАРА	KS / PCS / STŮCK / ЧАСТЬ	OE / OE NUMBER / OE NUMMER / OE	ROZMĚR / DIMENSION / DIMENSION / РАЗМЕРНОСТЬ
723794	<ul style="list-style-type: none"> ▪ hliník, reflexní ▪ aluminium, reflective ▪ aluminium, reflektierende ▪ алюминий, рефлекс 		▪		1200x400 mm



ReflexType®

KÓD / ORDER CODE / BESTELL NR. / КОД	MATERIÁL / MATERIAL / MATERIAL / МАТЕРИАЛ	PÁR / PAIR / PAAR / ПАРА	KS / PCS / STŮCK / ЧАСТЬ	OE / OE NUMBER / OE NUMMER / OE	ROZMĚR / DIMENSION / DIMENSION / РАЗМЕРНОСТЬ
723763	<ul style="list-style-type: none"> ▪ hliník, reflexní ▪ aluminium, reflective ▪ aluminium, reflektierende ▪ алюминий, рефлекс 		▪		450x450 mm

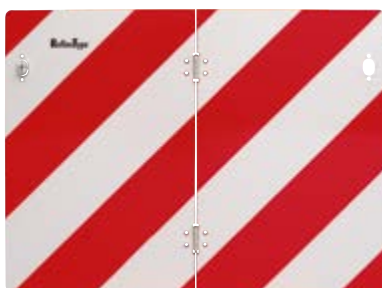

ReflexType®

KÓD / ORDER CODE / BESTELL NR. / КОД	MATERIÁL / MATERIAL / MATERIAL / МАТЕРИАЛ	PÁR / PAIR / PAAR / ПАРА	KS / PCS / STŮCK / ЧАСТЬ	OE / OE NUMBER / OE NUMMER / OE	ROZMĚR / DIMENSION / DIMENSION / РАЗМЕРНОСТЬ
723787	<ul style="list-style-type: none"> ▪ hliník, reflexní, sklopná ▪ aluminium, reflective, folding ▪ aluminium, reflektierende, klapp ▪ алюминий, рефлекс, складной 		▪		400x300 mm

**TABULE NADROZMĚR / BOARD OVERHANGING LOADS /
WARNTAFEL ÜBERSTEHENDE LADUNGEN / ТАБЛИЦЫ «НЕГАБАРИТНЫЙ ГРУЗ»**



ReflexType®

KÓD / ORDER CODE / BESTELL NR. / КОД	MATERIÁL / MATERIAL / MATERIAL / МАТЕРИАЛ	PÁR / PAIR / PAAR / ПАРА	KS / PCS / STÜCK / ЧАСТЬ	OE / OE NUMBER / OE NUMBER / OE	ROZMĚR / DIMENSION / DIMENSION / РАЗМЕРНОСТЬ
723785	<ul style="list-style-type: none"> ■ hliník, reflexní ■ aluminium, reflective ■ aluminium, reflektierende ■ алюминий, рефлекс 		■		423x423 mm



ReflexType®

KÓD / ORDER CODE / BESTELL NR. / КОД	MATERIÁL / MATERIAL / MATERIAL / МАТЕРИАЛ	PÁR / PAIR / PAAR / ПАРА	KS / PCS / STÜCK / ЧАСТЬ	OE / OE NUMBER / OE NUMBER / OE	ROZMĚR / DIMENSION / DIMENSION / РАЗМЕРНОСТЬ
723795	<ul style="list-style-type: none"> ■ hliník, reflexní s gumou ■ aluminium, reflective with rubber ■ aluminium, reflektierende mit gummi ■ алюминий, рефлекс с резиной 		■		423x423 mm



ReflexType®

KÓD / ORDER CODE / BESTELL NR. / КОД	MATERIÁL / MATERIAL / MATERIAL / МАТЕРИАЛ	PÁR / PAIR / PAAR / ПАРА	KS / PCS / STÜCK / ЧАСТЬ	OE / OE NUMBER / OE NUMBER / OE	ROZMĚR / DIMENSION / DIMENSION / РАЗМЕРНОСТЬ
723786	<ul style="list-style-type: none"> ■ hliník, reflexní ■ aluminium, reflective ■ aluminium, reflektierende ■ алюминий, рефлекс 		■		500x500 mm

**TABULE NADROZMĚR / BOARD OVERHANGING LOADS /
WARNTAFEL ÜBERSTEHENDE LADUNGEN / ТАБЛИЦЫ «НЕГАБАРИТНЫЙ ГРУЗ»**

ReflexType®

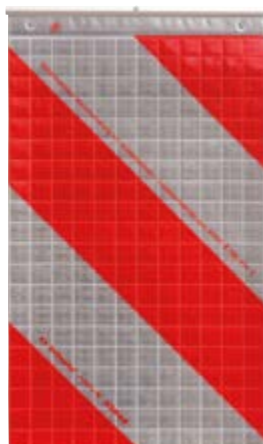

KÓD / ORDER CODE / BESTELL NR. / КОД	MATERIÁL / MATERIAL / MATERIAL / МАТЕРИАЛ	PÁR / PAIR / PAAR / ПАРА	KS / PCS / STŮCK / ЧАСТЬ	OE / OE NUMBER / OE NUMMER / OE	ROZMĚR / DIMENSION / DIMENSION / РАЗМЕРНОСТЬ
723791 PRAVÁ / RIGHT / RECHTS / Правая	<ul style="list-style-type: none"> ■ hydraulické čelo, reflexní ■ hydraulic lifter, reflective ■ hydraulischen Heber, reflektierende ■ гидравлический лоб, рефлекс 		■		250x400 mm
723792 LEVÁ / LEFT / LINKS / Левая					



ReflexType®

KÓD / ORDER CODE / BESTELL NR. / КОД	MATERIÁL / MATERIAL / MATERIAL / МАТЕРИАЛ	PÁR / PAIR / PAAR / ПАРА	KS / PCS / STŮCK / ЧАСТЬ	OE / OE NUMBER / OE NUMMER / OE	ROZMĚR / DIMENSION / DIMENSION / РАЗМЕРНОСТЬ
723788	<ul style="list-style-type: none"> ■ plachta, reflexní ■ flag, reflective ■ fahne, reflektierende ■ парус, рефлекс 		■		423x423 mm

**TABULE NADROZMĚR / BOARD OVERHANGING LOADS /
WARNTAFEL ÜBERSTEHENDE LADUNGEN / ТАБЛИЦЫ «НЕГАБАРИТНЫЙ ГРУЗ»**



ReflexType®

KÓD / ORDER CODE / BESTELL NR. / КОД	MATERIÁL / MATERIAL / MATERIAL / МАТЕРИАЛ	PÁR / PAIR / PAAR / ПАРА	KS / PCS / STÜCK / ЧАСТЬ	OE / OE NUMBER / OE NUMBER / OE	ROZMĚR / DIMENSION / DIMENSION / РАЗМЕРНОСТЬ
723789	<ul style="list-style-type: none"> ■ plachta, reflexní ■ flag, reflective ■ fahne, reflektierende ■ парус, рефлекс 		■		450x450 mm



ReflexType®

KÓD / ORDER CODE / BESTELL NR. / КОД	MATERIÁL / MATERIAL / MATERIAL / МАТЕРИАЛ	PÁR / PAIR / PAAR / ПАРА	KS / PCS / STÜCK / ЧАСТЬ	OE / OE NUMBER / OE NUMBER / OE	ROZMĚR / DIMENSION / DIMENSION / РАЗМЕРНОСТЬ
723790	<ul style="list-style-type: none"> ■ plachta, reflexní ■ flag, reflective ■ fahne, reflektierende ■ парус, рефлекс 		■		500x500 mm





ReflexType®

KÓD / ORDER CODE / BESTELL NR. / КОД	MATERIÁL / MATERIAL / MATERIAL / МАТЕРИАЛ	PÁR / PAIR / PAAR / ПАРА	KS / PCS / STÜCK / ЧАСТЬ	OE / OE NUMBER / OE NUMBER / OE	ROZMĚR / DIMENSION / DIMENSION / РАЗМЕРНОСТЬ
723758	<ul style="list-style-type: none"> ■ samolepka ■ sticker ■ aufkleber ■ наклейка 		■		400x300 mm

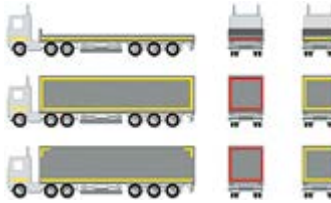

KÓD / ORDER CODE / BESTELL NR. / КОД	MATERIÁL / MATERIAL / MATERIAL / МАТЕРИАЛ	PÁR / PAIR / PAAR / ПАРА	KS / PCS / STÜCK / ЧАСТЬ	OE / OE NUMBER / OE NUMMER / OE	ROZMĚR / DIMENSION / DIMENSION / РАЗМЕРНОСТЬ
723925	<ul style="list-style-type: none">▪ hliník, reflexní▪ aluminium, reflective▪ aluminium, reflektierende▪ алюминий, рефлекс		▪		400x300 mm

REFLEXNÍ PÁSKY / REFLECTIVE STRIPES / KONTURMARKIERUNG / СВЕТООТРАЖАЮЩИЕ ЛЕНТЫ

KÓD / ORDER CODE / BESTELL NR. / КОД		POPIS / DESCRIPTION / BESCHREIBUNG / ОПИСАНИЕ	OE / OE NUMBER / OE NUMMER / OE	NÁKRES / DRAWING / ZEICHNUNG / ЧЕРТЕЖ
720476		<p>ECE  ReflexType®</p> <ul style="list-style-type: none"> ■ Pevný povrch, délka - 50 m ■ Solid surface, length - 50 m ■ Feste Oberfläche, länge - 50 m ■ твердая поверхность, длина - 50 м 		
720484		<p>ECE  ReflexType®</p> <ul style="list-style-type: none"> ■ Pevný povrch, délka - 50 m ■ Solid surface, length - 50 m ■ Feste Oberfläche, länge - 50 m ■ твердая поверхность, длина - 50 м 		
720483		<p>ECE  ReflexType®</p> <ul style="list-style-type: none"> ■ Pevný povrch, délka - 50 m ■ Solid surface, length - 50 m ■ Feste Oberfläche, länge - 50 m ■ твердая поверхность, длина - 50 м 		
723414		<p>ECE  ReflexType®</p> <ul style="list-style-type: none"> ■ Plachta, délka - 50 m ■ Sail, length - 50 m ■ Segel, länge - 50 m ■ парус, длина - 50 м 		
723410		<p>ECE  ReflexType®</p> <ul style="list-style-type: none"> ■ Plachta, délka-50 m ■ Sail, length - 50 m ■ Segel, länge-50 m ■ парус, длина - 50 м 		
723416		<p>ECE  ReflexType®</p> <ul style="list-style-type: none"> ■ Plachta, délka - 50 m ■ Sail, length - 50 m ■ Segel, länge - 50 m ■ парус, длина - 50 м 		

REFLEXNÍ PÁSKY / REFLECTIVE STRIPES / KONTURMARKIERUNG / СВЕТООТРАЖАЮЩИЕ ЛЕНТЫ



KÓD / ORDER CODE / BESTELL NR. / КОД	MATERIÁL / MATERIAL / MATERIAL / МАТЕРИАЛ	PÁR / PAIR / PAAR / ПАРА	KS / PCS / STÜCK / ЧАСТЬ	OE / OE NUMBER / OE NUMMER / OE	ROZMÉR / DIMENSION / DIMENSION / РАЗМЕРНОСТЬ
720550	<ul style="list-style-type: none"> ▪ reflexní ▪ reflective ▪ reflektierende ▪ рефлекс 	▪			2x9 m
720553	<ul style="list-style-type: none"> ▪ reflexní ▪ reflective ▪ reflektierende ▪ рефлекс 		▪	D12020	2x9 m
720555	<ul style="list-style-type: none"> ▪ reflexní ▪ reflective ▪ reflektierende ▪ рефлекс 	▪			2x9 m



OZNAČENÍ RYCHLOSTI / SPEED LIMIT / GESCHWINDIGKEITSSCHILDER / ЗНАКИ СКОРОСТИ ДВИЖЕНИЯ

ReflexType



	KÓD / ORDER CODE / BESTELL NR. / КОД	PÁR / PAIR / PAAR / ПАРА	KS / PCS / STÜCK / ЧАСТЬ	OE / OE NUMBER / OE NUMBER / OE	PRŮMĚR / DIAMETER / DURCHMESSER / ДИАМЕТРЫ
20 KM	723869 nereflexní, non-reflective, entspiegelt, неотражающая		■		Ø 200 mm
	723869/KM reflexní, reflective, reflektierende, рефлекс				
30 KM	723870 nereflexní, non-reflective, entspiegelt, неотражающая		■		Ø 200 mm
	723870/KM reflexní, reflective, reflektierende, рефлекс				
40 KM	723871 nereflexní, non-reflective, entspiegelt, неотражающая		■		Ø 200 mm
	723871/KM reflexní, reflective, reflektierende, рефлекс				
50 KM	723872 nereflexní, non-reflective, entspiegelt, неотражающая		■		Ø 200 mm
	723872/KM reflexní, reflective, reflektierende, рефлекс				
60 KM	723873 nereflexní, non-reflective, entspiegelt, неотражающая		■		Ø 200 mm
	723873/KM reflexní, reflective, reflektierende, рефлекс				
70 KM	723874 nereflexní, non-reflective, entspiegelt, неотражающая		■		Ø 200 mm
	723874/KM reflexní, reflective, reflektierende, рефлекс				
80 KM	723875 nereflexní, non-reflective, entspiegelt, неотражающая		■		Ø 200 mm
	723875/KM reflexní, reflective, reflektierende, рефлекс				
85 KM	723879 nereflexní, non-reflective, entspiegelt, неотражающая		■		Ø 200 mm
	723879/KM reflexní, reflective, reflektierende, рефлекс				
90 KM	723876 nereflexní, non-reflective, entspiegelt, неотражающая		■		Ø 200mm
	723876/KM reflexní, reflective, reflektierende, рефлекс				
100 KM	723877 nereflexní, non-reflective, entspiegelt, неотражающая		■		Ø 200 mm
	723877/KM reflexní, reflective, reflektierende, рефлекс				
110 KM	723878 nereflexní, non-reflective, entspiegelt, неотражающая		■		Ø 200 mm
	723878/KM reflexní, reflective, reflektierende, рефлекс				

450 kPa

500 kPa

550 kPa

600 kPa

650 kPa

700 kPa

750 kPa

800 kPa





850 kPa

900 kPa





950 kPa

	KÓD / ORDER CODE / BESTELL NR. / КОД	PÁR / PAIR / PAAR / ПАРА	KS / PCS / STÜCK / ЧАСТЬ	OE / OE NUMBER / OE NUMMER / OE	PRŮMĚR / DIAMETER / DURCHMESSER / ДИАМЕТРЫ
450 kPa	723997 samolepka, sticker, aufkleber, наклейка		■		80x40 mm
500 kPa	724000 samolepka, sticker, aufkleber, наклейка		■		80x40 mm
550 kPa	724001 samolepka, sticker, aufkleber, наклейка		■		80x40 mm
600 kPa	723999 samolepka, sticker, aufkleber, наклейка		■		80x40 mm
650 kPa	724002 samolepka, sticker, aufkleber, наклейка		■		80x40 mm
700 kPa	723998 samolepka, sticker, aufkleber, наклейка		■		80x40 mm
750 kPa	723996 samolepka, sticker, aufkleber, наклейка		■		80x40 mm
800 kPa	723995 samolepka, sticker, aufkleber, наклейка		■		80x40 mm
850 kPa	723993 samolepka, sticker, aufkleber, наклейка		■		80x40 mm
900 kPa	723994 samolepka, sticker, aufkleber, наклейка		■		80x40 mm
950 kPa	724005 samolepka, sticker, aufkleber, наклейка		■		80x40 mm

**OZNAČENÍ EMISÍ / VEHICLE EMISSION LABEL /
FAHRZEUGEMISSIONEN ANZEIGE / МАРКИРОВКА АВТОМОБИЛЬ ЭМИССИИ**

KÓD / ORDER CODE / BESTELL NR. / КОД		POPIS / DESCRIPTION / BESCHREIBUNG / ОПИСАНИЕ
723861	<p>ReflexType®</p> 	<ul style="list-style-type: none"> ■ Vyjíмка z nočního zákazu jízdy, průměr: 220 mm ■ Exemptions from the ban on night rides, diameter: 220 mm ■ Ausnahmen vom Verbot der Nachtfahrten, durchmesser: 220 mm ■ Исключения из запрета на вождение в ночное время, диаметр: 220 mm
723862	<p>ReflexType®</p> 	<ul style="list-style-type: none"> ■ Vozidlo s emisemi splňujícími předpis 92/1, průměr: 220 mm ■ Vehicle Emissions complying with regulation 92/1, diameter: 220 mm ■ Fahrzeugemissionen nach Regel 92/1, durchmesser: 220 mm ■ Выбросы транспортных средств соответствуют рецепту 92/1, диаметр: 220 mm
723863	<p>ReflexType®</p> 	<ul style="list-style-type: none"> ■ Splňuje normy hlučnosti i emisí a také normu EURO 2, průměr: 220 mm ■ Meets noise level and emissions and the EURO 2, diameter: 220 mm ■ Erfüllt Emissionen und Geräuschpegel und die EURO 2, durchmesser: 220 mm ■ Соответствует стандартам шума и эмиссии, а также Евро 2, диаметр: 220 mm
723864	<p>ReflexType®</p> 	<ul style="list-style-type: none"> ■ Vozidlo s nízkou hlučností, průměr: 220 mm ■ Vehicle with low noise, diameter: 220 mm ■ Fahrzeug mit geringem Rauschen, durchmesser: 220 mm ■ Транспортное средство с низким уровнем шума, диаметр: 220 mm

**OZNAČENÍ EMISÍ / VEHICLE EMISSION LABEL /
FAHRZEUGEMISSIONEN ANZEIGE / МАРКИРОВКА АВТОМОБИЛЬ ЭМИССИИ**

KÓD / ORDER CODE / BESTELL NR. / КОД		POPIS / DESCRIPTION / BESCHREIBUNG / ОПИСАНИЕ
723865	<p>ReflexType®</p> 	<ul style="list-style-type: none"> ■ EURO III, průměr: 220 mm ■ EURO III, diameter: 220 mm ■ EURO III, durchmesser: 220 mm ■ Евро III, диаметр: 220 mm
723866	<p>ReflexType®</p> 	<ul style="list-style-type: none"> ■ EURO IV, průměr: 220 mm ■ EURO IV, diameter: 220 mm ■ EURO IV, durchmesser: 220 mm ■ Евро IV, диаметр: 220 mm
723867	<p>ReflexType®</p> 	<ul style="list-style-type: none"> ■ EURO V, průměr: 220 mm ■ EURO V, diameter: 220 mm ■ EURO V, durchmesser: 220 mm ■ Евро V, диаметр: 220 mm
723868	<p>ReflexType®</p> 	<ul style="list-style-type: none"> ■ EURO VI, průměr: 220 mm ■ EURO VI, diameter: 220 mm ■ EURO VI, durchmesser: 220 mm ■ Евро VI, диаметр: 220 mm

SAMOLEPKA „CZ“ / ADHESIVE „CZ“ /
SELBSTKLEBEND „CZ“ / НАКЛЕЙКА „CZ“



KÓD / ORDER CODE / BESTELL NR. / КОД	MATERIÁL / MATERIAL / MATERIAL / МАТЕРИАЛ	PÁR / PAIR / PAAR / ПАРА	KS / PCS / STÜCK / ЧАСТЬ	OE / OE NUMBER / OE NUMMER / OE	ROZMĚR / DIMENSION / DIMENSION / РАЗМЕРНОСТЬ
724004	<ul style="list-style-type: none">▪ Samolepka▪ Adhesive▪ Selbstklebend▪ наклейка		▪		175x120 mm

**KAMEROVÉ SYSTÉMY /
CAMERA SYSTEMS /
KAMERASYSTEME /
СИСТЕМЫ ВИДЕОНАБЛЮДЕНИЯ**



BRIGHT VIEW

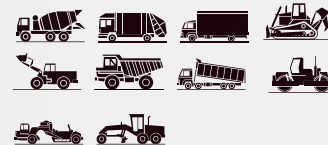

KÓD / ORDER CODE /
BESTELL NR. / КОД

POPIS / DESCRIPTION / BESCHREIBUNG / ОПИСАНИЕ

727948

- KIT obsahuje: 1x 7" zrcadlový monitor s barevným displejem a 4 vstupními kanály - funkce Quad (+CZ manuál, dálkový ovladač, sluneční clona); 1x vodotěsná a prachuvzdorná couvací kamera s nočním viděním a vytápěním (+CZ manuál, zrcadlový mód); 1x vodotěsná a prachuvzdorná boční kamera s nočním viděním (+CZ manuál), 1x propojovací kabel délky 15 m (typ kabelu: aviation), 2x propojovací kabel délky 5 m (typ kabelu: aviation)
- KIT contains: 1x 7" color mirror monitor with 4 input channels with quad function (+operation manual, remote control, sunvisor); 1x waterproof&dustproof rearview camera with night vision and heating (operation manual, mirror mode); 2x waterproof&dustproof sideview camera with night vision (+operation manual), 1x connecting cable 15 m (aviation type), 2x connecting cable 5 m (aviation type)
- KIT enthalten: 1x 7" Spiegel-Farbmonitor mit 4 Eingangskanälen und Quad Funktion (+Bedienungsanleitung, Fernbedienung, Sonnenblende); 1x wasserdicht und staubdicht Kamera mit Nachtsicht und Heizung, Spiegelmodus (+Bedienungsanleitung); 2x wasserdicht und staubdicht Seite-Kamera mit nachtsicht (+Bedienungsanleitung); 1x Verbindungskabel 15 m (Aviation typ), 2x Verbindungskabel 5 m (Aviation typ)
- Комплект включает в себя: 1x 7-дюймовый зеркальный монитор с цветным дисплеем и 4 входными каналами - функция Quad (ручная, дистанционное управление, солнцезащитный козырек); 1x водонепроницаемая и пылезащитная камера заднего вида с ночным видением и обогревом (+ руководство, режим зеркала); 1x водонепроницаемая и пыленепроницаемая камера с боковым обзором (+ руководство), 1x соединительный кабель длиной 15 м (тип кабеля: авиация), 2x длина кабеля 5 м (тип кабеля: авиация)

BRIGHT VIEW



KÓD / ORDER CODE /
BESTELL NR. / КОД

POPIS / DESCRIPTION / BESCHREIBUNG / ОПИСАНИЕ

727946

- KIT obsahuje: 1x 7" monitor s barevným displejem a 4 vstupními kanály (+CZ manuál, dálkový ovladač, sluneční clona); 1x vodotěsná a prachuvzdorná couvací kamera s nočním viděním, vytápěním a možností zrcadlového obrazu (120° pozorovací úhel, CZ manuál); 1x vodotěsná a prachuvzdorná couvací kamera s nočním viděním (70° pozorovací úhel, CZ manuál); 2x propojovací kabel délky 5 m (typ kabelu: aviation)
- KIT contains: 1x 7" color monitor with 4 input channels (+operation manual, remote control, sunvisor); 1x waterproof&dustproof camera with night vision, heating and mirror mode (120° view angle, operation manual); 1x waterproof&dustproof camera with night vision (70° view angle, operation manual); 2x connecting cable 5 m (aviation type)
- KIT enthalten: 1x 7" Farbmonitor mit 4 Eingangskanälen (+Bedienungsanleitung, Fernbedienung, Sonnenblende); 1x wasserdicht und staubdicht Kamera mit Nachtsicht, Heizung und Spiegelmodus (Linsenwinkel 120°, Bedienungsanleitung); 1x wasserdicht und staubdicht Kamera mit Nachtsicht (Linsenwinkel 70°; Bedienungsanleitung); 2x Verbindungskabel 5 m (Aviation typ)
- Комплект включает в себя: 1 x 7 «монитор с цветным дисплеем и 4 входных канала (+ руководство, пультом дистанционного управления, солнцезащитный козырек), 1x водонепроницаемая и пылезащитная камера заднего вида с ночным видением, возможность нагрева и зеркального изображения (120° Угол обзора по эксплуатации GB); 1x водонепроницаемый и пылезащитный камера заднего вида с ночным видением (70° угол обзора, ручной GB); 2x Длина соединительного кабеля 5 м (тип кабеля: авиация).



KÓD / ORDER CODE / BESTELL NR. / КОД	POPIS / DESCRIPTION / BESCHREIBUNG / ОПИСАНИЕ
727930	<ul style="list-style-type: none"> ■ Sada obsahuje: 1 x 7" monitor s barevným displejem a 2 vstupními kanály (+CZ manuál, dálkový ovladač, sluneční clona); 1x vodotěsná a prachuvzdorná couvací kamera s nočním viděním a možností zrcadlového obrazu (+CZ manuál); 1x propojovací kabel délky 15 m (typ kabelu: aviation) ■ KIT contains: 1 x 7" color monitor with 2 input channels (+operation manual, remote control, sunvisor); 1x waterproof&dustproof camera with night vision and mirror mode (+operation manual); 1x connecting cable 15 m (aviation type) ■ KIT enthalten: 1 x 7" Farbmonitor mit 2 Eingangskanälen (+Bedienungsanleitung, Fernbedienung, Sonnenblende); 1x wasserdicht und staubdicht Kamera mit Nachtsicht und Spiegelmodus (+Bedienungsanleitung); 1x Verbindungskabel 15 m (aviation typ) ■ Устройство состоит из: 1 x 7" монитор с цветным дисплеем и 2 входными каналами (+ инструкция на русском языке, пульт управления на расстояние, солнцезащитный щит); 1x водозащитная и пылезащитная камера заднего хода с ночным видением и с функцией наставки зеркального отображения (+инструкция); 1x соединяющий кабель длиной 15 м (тип кабеля : aviation)



KÓD / ORDER CODE / BESTELL NR. / КОД	POPIS / DESCRIPTION / BESCHREIBUNG / ОПИСАНИЕ
727931	<ul style="list-style-type: none"> ■ Sada obsahuje: 1 x 7" monitor s barevným displejem a 4 vstupními kanály (+CZ manuál, dálkový ovladač, sluneční clona); 1x vodotěsná a prachuvzdorná couvací kamera s nočním viděním a možností zrcadlového obrazu (+CZ manuál); 1x propojovací kabel délky 15 m (typ kabelu: aviation) ■ KIT contains: 1 x 7" color monitor with 4 input channels (+operation manual, remote control, sunvisor); 1x waterproof&dustproof camera with night vision and mirror mode (+operation manual); 1x connecting cable 15 m (aviation type) ■ KIT enthalten: 1 x 7" Farbmonitor mit 4 Eingangskanälen (+Bedienungsanleitung, Fernbedienung, Sonnenblende); 1x wasserdicht und staubdicht Kamera mit Nachtsicht und Spiegelmodus (+Bedienungsanleitung); 1x Verbindungskabel 15 m (aviation typ) ■ Устройство состоит из: 1 x 7" монитор с цветным дисплеем и 4 входными каналами (+ инструкция на русском языке, пульт управления на расстояние, солнцезащитный щит); 1x водозащитная и пылезащитная камера заднего хода с ночным видением и с функцией наставки зеркального отображения (+инструкция); 1x соединяющий кабель длиной 15 м (тип кабеля : aviation)



KÓD / ORDER CODE / BESTELL NR. / КОД	POPIS / DESCRIPTION / BESCHREIBUNG / ОПИСАНИЕ
727939	<ul style="list-style-type: none"> ■ Sada obsahuje: 1 x 7" monitor s barevným displejem a 2 vstupními kanály (+CZ manuál, dálkový ovladač, sluneční clona); 1x vodotěsná a prachuvzdorná couvací kamera s nočním viděním a možností zrcadlového obrazu (+CZ manuál); 1x kabelový set pro připojení tahače/návěsu (5 m, 20 m + spirál. kabel 4 m - koncovky Jaegger) ■ KIT contains: 1 x 7" color monitor with 2 input channels (+operation manual, remote control, sunvisor); 1x waterproof&dustproof camera with night vision and mirror mode (+operation manual); 1x cable set for connecting trailers (5 m, 20 m, 4 m - spiral cable with Jaeger connectors) ■ KIT enthalten: 1 x 7" Farbmonitor mit 2 Eingangskanälen (+Bedienungsanleitung, Fernbedienung, Sonnenblende); 1x wasserdicht und staubdicht Kamera mit Nachtsicht und Spiegelmodus (+Bedienungsanleitung); Kabelsatz für den Anschluss von Anhänger (5 m, 20 m, 4 m - spiral Kabel with Jaeger Anschlüsse) ■ Устройство состоит из: 1 x 7" монитор с цветным дисплеем и 2 входными каналами (+ инструкция на русском языке, пульт управления на расстояние, солнцезащитный щит); 1x водозащитная и пылезащитная камера заднего хода с ночным видением и с функцией наставки зеркального отображения (+инструкция); 1x соединяющий комплект кабеля для соединения к тягачу/ прицепу (5 м, 20 м + спиральный кабель 4 м. – вставная вилка марки Jaegger)



KÓD / ORDER CODE / BESTELL NR. / КОД	POPIS / DESCRIPTION / BESCHREIBUNG / ОПИСАНИЕ
727940	<ul style="list-style-type: none"> ■ Sada obsahuje: 1 x 7" monitor s barevným displejem a 4 vstupními kanály (+CZ manuál, dálkový ovladač, sluneční clona); 1x vodotěsná a prachuvzdorná couvací kamera s nočním viděním a možností zrcadlového obrazu (+CZ manuál); 1x kabelový set pro připojení tahače/návěsu (5 m, 20 m + spirál. kabel 4 m - koncovky Jaegger) ■ KIT contains: 1 x 7" color monitor with 4 input channels (+operation manual, remote control, sunvisor); 1x waterproof&dustproof camera with night vision and mirror mode (+operation manual); 1x cable set for connecting trailers (5 m, 20 m, 4 m - spiral cable with Jaeger connectors) ■ KIT enthalten: 1 x 7" Farbmonitor mit 4 Eingangskanälen (+Bedienungsanleitung, Fernbedienung, Sonnenblende); 1x wasserdicht und staubdicht Kamera mit Nachtsicht und Spiegelmodus (+Bedienungsanleitung); Kabelsatz für den Anschluss von Anhänger (5 m, 20 m, 4 m - spiral Kabel with Jaeger Anschlüsse) ■ Устройство состоит из: 1 x 7" монитор с цветным дисплеем и 4 входными каналами (+ инструкция на русском языке, пульт управления на расстояние, солнцезащитный щит); 1x водозащитная и пылезащитная камера заднего хода с ночным видением и с функцией наставки зеркального отображения (+инструкция); 1x соединяющий комплект кабеля для соединения к тягачу/ прицепу (5 м, 20 м + спиральный кабель 4 м. – вставная вилка марки Jaegger)



KÓD / ORDER CODE / BESTELL NR. / КОД	POPIS / DESCRIPTION / BESCHREIBUNG / ОПИСАНИЕ			
727920	<ul style="list-style-type: none"> ■ Vstup: 2 kanály ■ Obrazovka: 7" TFT-LCD ■ Obraz: 16:9 širokoúhlý ■ Rozlišení: 800x480 RGB ■ Barevný obraz: ano ■ Napájení: 12-32 V ■ Operační teploty: -10 °C do +65 °C ■ Zapnutí při couvání: automaticky ■ Reproduktor: ne/lze přidat ■ Sluneční clona: ano ■ Dálkové ovládání: ano 	<ul style="list-style-type: none"> ■ Video Input: 2 channels ■ Screen size: 7" TFT-LCD ■ Type: 16:9 wide screen ■ Resolution: 800x480 RGB ■ Color: yes ■ Power supply: 12-32 V ■ Operating temperature: -10 °C to +65 °C ■ Reverse trigger: automatically ■ Speaker: no/possible adding ■ Sun visor: yes ■ Remote control: yes 	<ul style="list-style-type: none"> ■ Video-Eingang: 2 Kanalän ■ Bildschirmgröße: 7" TFT-LCD ■ Typ: 16:9 breite Bildschirm ■ Lösung: 800x480 RGB ■ Farbbild: ja ■ Energieversorgung: 12-32 V ■ Betriebstemperatur: -10 °C to +65 °C ■ Schalten beim Rückwärtsfahren: automatisch ■ Redner: nein/ möglich Hinzufügen ■ Sonnenblende: ja ■ Fernbedienung: ja 	<ul style="list-style-type: none"> ■ Видео вход: 2 каналы ■ Размер экрана: 7" TFT LCD ■ Тип: 16:9 широкий экран ■ Решение: 800x480 RGB ■ Цвет: Да ■ Электропитание: 12-32 V ■ Рабочая температура: от -10 °C до +65 °C ■ Переключение при движении задним ходом: автоматически ■ Оратор: нет / возможно добавление ■ Солнцезащитный козырек: да ■ Пульт дистанционного управления: да



KÓD / ORDER CODE / BESTELL NR. / КОД	POPIS / DESCRIPTION / BESCHREIBUNG / ОПИСАНИЕ			
727921	<ul style="list-style-type: none"> ■ Vstup: 4 kanály ■ Obrazovka: 7" TFT-LCD ■ Obraz: 16:9 širokoúhlý ■ Rozlišení: 800x480 RGB ■ Barevný obraz: ano ■ Napájení: 12-32 V ■ Operační teploty: -10 °C do +65 °C ■ Zapnutí při couvání: automaticky ■ Reproduktor: ne/ lze přidat ■ Sluneční clona: ano ■ Dálkové ovládání: ano 	<ul style="list-style-type: none"> ■ Video Input: 4 channels ■ Screen size: 7" TFT-LCD ■ Type: 16:9 wide screen ■ Resolution: 800x480 RGB ■ Color: yes ■ Power supply: 12-32 V ■ Operating temperature: -10 °C to +65 °C ■ Reverse trigger: automatically ■ Speaker: no/ possible adding ■ Sun visor: yes ■ Remote control: yes 	<ul style="list-style-type: none"> ■ Video-Eingang: 4 Kanalän ■ Bildschirmgröße: 7" TFT-LCD ■ Typ: 16:9 breite Bildschirm ■ Lösung: 800x480 RGB ■ Farbbild: ja ■ Energieversorgung: 12-32 V ■ Betriebstemperatur: -10 °C to +65 °C ■ Schalten beim Rückwärtsfahren: automatisch ■ Redner: nein/ möglich Hinzufügen ■ Sonnenblende: ja ■ Fernbedienung: ja 	<ul style="list-style-type: none"> ■ Видео вход: 4 каналы ■ Размер экрана: 7" TFT LCD ■ Тип: 16:9 широкий экран ■ Решение: 800x480 RGB ■ Цвет: Да ■ Электропитание: 12-32 V ■ Рабочая температура: от -10 °C до +65 °C ■ Переключение при движении задним ходом: автоматически ■ Оратор: нет / возможно добавление ■ Солнцезащитный козырек: да ■ Пульт дистанционного управления: да



**KAMERA COUVACÍ / REARVIEW CAMERA /
RÜCKFAHR KAMERA / КАМЕРА ЗАДНЕГО ВИДА**

727936



**KAMERA BOČNÍ / SIDE CAMERA /
SEITENANSICHT KAMERA / БОКОВЫЕ КАМЕРА**

727923



KÓD / ORDER CODE / BESTELL NR. / КОД	POPIS / DESCRIPTION / BESCHREIBUNG / ОПИСАНИЕ			
727936	<ul style="list-style-type: none"> ■ Sensor: 1/4 Sharp CCD ■ Rozlišení: 420 TV řádků ■ Mikrofon: ne / lze přidat ■ Min. osvětlení: 0 LUX ■ Vzd. noční vidění: 13,75 m ■ LED osvětlení: 18 kusů ■ Vodotěsnost: IP69K ■ Pozorovací úhel: 120° ■ Operační teploty: -20 °C až +70 °C ■ Napájení: 12V z monitoru ■ Vyhřívání: ano 	<ul style="list-style-type: none"> ■ Sensor: 1/4 Sharp CCD ■ Resolution: 420 TV line ■ Microphone: no / possible adding ■ Min. illumination: 0 LUX ■ Night vision distance: 13,75 m ■ IR LED: 18 pcs ■ Waterproof: IP69K ■ View angle: 120° ■ Operation temp.: -20 °C to +70 °C ■ Power supply: 12V from monitor ■ Heating: yes 	<ul style="list-style-type: none"> ■ Sensor: 1/4 Sharp CCD ■ Lösung: 420 TV line ■ Mikrofon: nein / möglich hinzufügen ■ Min. Erleuchtung: 0 LUX ■ Nachtsichtabstand: 13,75 m ■ R LED: 18 Stücke ■ Wasserdicht: IP69K ■ Betrachtungswinkel: 120° ■ Betriebstemperatur: -20 °C to +70 °C ■ Energieversorgung: 12V aus monitor ■ Heizung: ja 	<ul style="list-style-type: none"> ■ Сенсор: 1/4 Sharp CCD ■ Разрешение: 420 ТВ линий ■ Микрофон: нет / возможно добавление ■ Минимум освещения: 0 LUX ■ Расстояние ночного видения: 13,75 м ■ IR LED: 18 шт ■ Водонепроницаемость: IP69K ■ Угол обзора: 120 ° ■ Операция темп.: -20 °C до +70 °C ■ Напряжение питания: 12В от монитора ■ Отопление: да
727923	<ul style="list-style-type: none"> ■ Sensor: 1/4 Sharp CCD ■ Rozlišení: 420 TV řádků ■ Mikrofon: ne / lze přidat ■ Min. osvětlení: 0 LUX ■ Vzd. noční vidění: 10,65 m ■ LED osvětlení: 9 kusů ■ Vodotěsnost: IP68 ■ Pozorovací úhel: 120° ■ Operační teploty: -20°C až +70°C ■ Napájení: 12V z monitoru ■ Vyhřívání: ne/ lze přidat 	<ul style="list-style-type: none"> ■ Sensor: 1/4 Sharp CCD ■ Resolution: 420 TV line ■ Microphone: no / possible adding ■ Min. illumination: 0 LUX ■ Night vision distance: 10,65 m ■ IR LED: 9 pcs ■ Waterproof: IP68 ■ View angle: 120° ■ Operation temp.: -20°C to +70°C ■ Power supply: 12V from monitor ■ Heating: no/possible adding 	<ul style="list-style-type: none"> ■ Sensor: 1/4 Sharp CCD ■ Lösung: 420 TV line ■ Mikrofon: nein / möglich hinzufügen ■ Min. Erleuchtung: 0 LUX ■ Nachtsichtabstand: 10,65 m ■ R LED: 9 Stücke ■ Wasserdicht: IP68 ■ Betrachtungswinkel: 120° ■ Betriebstemperatur: -20°C to +70°C ■ Energieversorgung: 12V aus monitor ■ Heizung: nein/ möglich hinzufügen 	<ul style="list-style-type: none"> ■ Сенсор: 1/4 Sharp CCD ■ Разрешение: 420 ТВ линий ■ Микрофон: нет / возможно добавление ■ Минимум освещение: 0 LUX ■ Расстояние ночного видения: 10,65 м ■ IR LED: 9 шт ■ Водонепроницаемость: IP68 ■ Угол обзора: 120 ° ■ Операция темп.: -20 °C до +70 °C ■ Напряжение питания: 12В от монитора ■ Отопление: нет / возможно добавление

KAMEROVÉ SYSTÉMY / CAMERA SYSTEMS / KAMERASYSTEME / СИСТЕМЫ ВИДЕОНАБЛЮДЕНИЯ



**KAMERA VNITŘNÍ / INDOOR CAMERA /
INNEN KAMERA / ВНУТРЕННЯЯ КАМЕРА**

727924



**KAMERA - POZOROVACÍ ÚHEL 70° /
CAMERA - VIEW ANGLE 70° /
KAMERA - LINSENWINKEL 70° /
КАМЕРА - СМОТРЕТЬ УГОЛ 70°**

727956



KÓD / ORDER CODE / BESTELL NR. / КОД	POPIS / DESCRIPTION / BESCHREIBUNG / ОПИСАНИЕ			
727924	<ul style="list-style-type: none"> ■ Sensor: 1/4 Sharp CCD ■ Rozlišení: 420 TV řádků ■ Mikrofon: ne / lze přidat ■ Min. osvětlení 0 LUX ■ Vzd. noční vidění: 13,75 m ■ LED osvětlení: 24 kusů ■ Vodotěsnost: ne ■ Pozorovací úhel: 120° ■ Operační teploty: -20°C až +70°C ■ Napájení: 12V z monitoru ■ Vyhřívání: ne/ lze přidat 	<ul style="list-style-type: none"> ■ Sensor: 1/4 Sharp CCD ■ Resolution: 420 TV line ■ Microphone: no / possible adding ■ Min. illumination: 0 LUX ■ Night vision distance: 13,75 m ■ IR LED: 24 pcs ■ Waterproof: no ■ View angle: 120° ■ Operation temp.: -20°C to +70°C ■ Power supply: 12V from monitor ■ Heating: no/possible adding 	<ul style="list-style-type: none"> ■ Sensor: 1/4 Sharp CCD ■ Lösung: 420 TV line ■ Mikrofon: nein / möglich Hinzufügen ■ Min. Erleuchtung: 0 LUX ■ Nachtsichtabstand: 13,75 m ■ R LED: 24 Stücke ■ Wasserdicht: nein ■ Betrachtungswinkel: 120° ■ Betriebstemperatur: -20°C to +70°C ■ Energieversorgung: 12V aus monitor ■ Heizung: nein/ möglich Hinzufügen 	<ul style="list-style-type: none"> ■ Сенсор: 1/4 Sharp CCD ■ Разрешение: 420 ТВ линий ■ Микрофон: нет / возможно добавление ■ Минимум освещенности: 0 LUX ■ Расстояние ночного видения: 13,75 м ■ IR LED: 24 шт ■ Водонепроницаемость: нет ■ Угол обзора: 120° ■ Операция темп.: -20 ° С до + 70 ° С ■ Напряжение питания: 12В от монитора ■ Отопление: нет / возможно добавление
727956	<ul style="list-style-type: none"> ■ Sensor: 1/4 Sharp CCD ■ Rozlišení: 420 TV řádků ■ Mikrofon: ne ■ Min. osvětlení 0 LUX ■ Vzd. noční vidění: 10,65 m ■ LED osvětlení: 9 kusů ■ Vodotěsnost: IP68 ■ Pozorovací úhel: 70° ■ Operační teploty: -20°C až +70°C ■ Napájení: 12V z monitoru ■ Vyhřívání: ano 	<ul style="list-style-type: none"> ■ Sensor: 1/4 Sharp CCD ■ Resolution: 420 TV line ■ Microphone: no ■ Min. illumination: 0 LUX ■ Night vision distance: 10,65 m ■ IR LED: 9 pcs ■ Waterproof: IP68 ■ View angle: 70° ■ Operation temp.: -20°C to +70°C ■ Power supply: 12V from monitor ■ Heating: yes 	<ul style="list-style-type: none"> ■ Sensor: 1/4 Sharp CCD ■ Lösung: 420 TV line ■ Mikrofon: nein ■ Min. Erleuchtung: 0 LUX ■ Nachtsichtabstand: 10,65 m ■ R LED: 9 Stücke ■ Wasserdicht: IP68 ■ Betrachtungswinkel: 70° ■ Betriebstemperatur: -20°C to +70°C ■ Energieversorgung: 12V aus monitor ■ Heizung: ja 	<ul style="list-style-type: none"> ■ Сенсор: 1/4 Sharp CCD ■ Разрешение: 420 ТВ линий ■ Микрофон: нет ■ Минимум освещенности: 0 LUX ■ Расстояние ночного видения: 10,65 м ■ IR LED: 9 шт ■ Водонепроницаемость: IP68 ■ Угол обзора: 70° ■ Операция темп.: -20 ° С до + 70 ° С ■ Напряжение питания: 12В от монитора ■ Отопление: Да



**PROPOJOVACÍ KABEL (TYP AVIATION) / CONNECTION CABLE (TYPE AVIATION) /
VERBINDUNG KABEL (TYP AVIATION) / СОЕДИНИТЕЛЬНЫЙ КАБЕЛЬ (ТИП AVIATION)**



KÓD / ORDER CODE / BESTELL NR. / КОД	ROPOJOVACÍ KABEL / CONNECTION CABLE / VERBINDUNG KABEL / СОЕДИНИТЕЛЬНЫЙ КАБЕЛЬ			
	5 M	10 M	15 M	20 M
727927	■			
727926		■		
727928			■	
727925				■

**KABELOVÝ SET PRO PŘIPOJENÍ TAHAČE/NÁVĚSU / CABLE SET FOR CONNECTING TRAILERS /
KABELSATZ FÜR DEN ANSCHLUSS VON ANHÄNGER / НАБОР КАБЕЛЕЙ ДЛЯ ПОДКЛЮЧЕНИЯ ТРЕЙЛЕРОВ**

727938

727929



KÓD / ORDER CODE / BESTELL NR. / КОД	(5 M,15 M + SPIRÁL. KABEL 4 M) / (5 M,15 M,+ 4 M- SPIRAL CABLE) / (5 M,15 M, + 4 M-SPIRAL KABEL) / (5 M,15 M, + 4 M СПИРАЛЬНЫЙ КАБЕЛЬ)	(5 M,20 M + SPIRÁL. KABEL 4 M - KONCOVKA JAEGER) / (5 M,20 M, 4 M-SPIRAL CABLE WITH JAEGER CONNECTORS) / (5 M,20 M, 4 M - SPIRAL KABEL MIT JAEGER ANSCHLÜSSE) / (5 M,15 M, + 4 M СПИРАЛЬНЫЙ КАБЕЛЬ - ОКОНЧАНИЕ JAEGER)
727938	■	
727929		■

KAMEROVÉ SYSTÉMY / CAMERA SYSTEMS / KAMERASYSTEME / СИСТЕМЫ ВИДЕОНАБЛЮДЕНИЯ

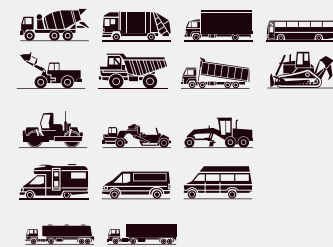

KÓD / ORDER CODE / BESTELL NR. / КОД	POPIS / DESCRIPTION / BESCHREIBUNG / ОПИСАНИЕ
727942	<ul style="list-style-type: none"> ■ Wi-Fi KIT obsahuje: 1x 7" monitor s barevným displejem a 3 vstupními kanály (+CZ manuál, dálkový ovladač, sluneční clona); 1x vodotěsná a prachuvzdorná couvací kamera s nočním viděním a možností zrcadlového obrazu (+CZ manuál). ■ Wi-Fi KIT contains: 1x 7" color monitor with 3 input channels (+operation manual, remote control, sunvisor); 1x waterproof&dustproof camera with night vision and mirror mode (+operation manual). ■ Wi-Fi KIT enthalten: 1x 7" Farbmonitor mit 3 Eingangskanälen (+Bedienungsanleitung, Fernbedienung, Sonnenblende); 1x wasserdicht und staubdicht Kamera mit Nachtsicht und Spiegelmodus (+Bedienungsanleitung). ■ Wi-Fi комплект включает: 1 x 7 «монитор с цветным дисплеем и 3 входных канала (+ руководство, пульт дистанционного управления, Зонт); Водонепроницаемый и пылезащитный камера заднего вида 1x с ночным видением и возможностями зеркального изображения (+ руководство).

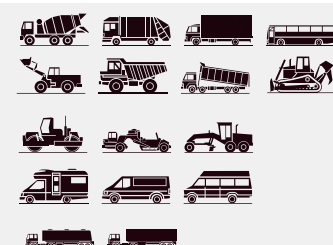

KÓD / ORDER CODE / BESTELL NR. / КОД	POPIS / DESCRIPTION / BESCHREIBUNG / ОПИСАНИЕ
727943	<ul style="list-style-type: none"> ■ Wi-Fi KIT obsahuje: 1x 5,6" monitor s barevným displejem a 3 vstupními kanály (+CZ manuál, dálkový ovladač, sluneční clona); 1x vodotěsná a prachuvzdorná couvací kamera s nočním viděním a možností zrcadlového obrazu (+CZ manuál). ■ Wi-Fi KIT contains: 1x 5,6" color monitor with 3 input channels (+operation manual, remote control, sunvisor); 1x waterproof&dustproof camera with night vision and mirror mode (+operation manual). ■ KIT enthalten: 1x 5,6" Farbmonitor mit 3 Eingangskanälen (+Bedienungsanleitung, Fernbedienung, Sonnenblende); 1x wasserdicht und staubdicht Kamera mit Nachtsicht und Spiegelmodus (+Bedienungsanleitung). ■ Wi-Fi комплект включает: 1 x 5,6 «монитор с цветным дисплеем и 3 входных каналов (+ руководство, пульт дистанционного управления, солнцезащитный козырек); Водонепроницаемый и пылезащитный камера заднего вида 1 с ночным видением и возможностями зеркального изображения (+ руководство).

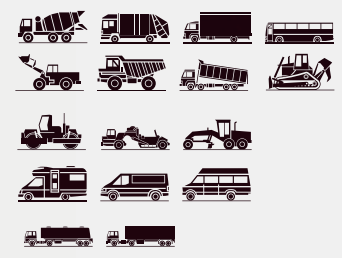

KÓD / ORDER CODE / BESTELL NR. / КОД	POPIS / DESCRIPTION / BESCHREIBUNG / ОПИСАНИЕ
728005	<ul style="list-style-type: none"> ■ Wi-Fi KIT obsahuje: 1x 7" monitor s barevným displejem a 2 vstupními kanály (+CZ manuál, dálkový ovladač, sluneční clona); 1x vodotěsná couvací kamera s nočním viděním a (+CZ manuál). ■ Wi-Fi KIT contains: 1x 7" color monitor with 2 input channels (+operation manual, remote control, sunvisor); 1x waterproof camera with night vision (+operation manual). ■ KIT enthalten: 1x 7" Farbmonitor mit 2 Eingangskanälen (+Bedienungsanleitung, Fernbedienung, Sonnenblende); 1x wasserdicht Kamera mit Nachtsicht (+Bedienungsanleitung). ■ Wi-Fi, комплект включает в себя: 1 x 7 «монитор с цветным дисплеем и 2 входных канала (+ руководство, пульт дистанционного управления, солнцезащитный козырек); Камера вида сзади водонепроницаемо 1ночным видением (+ руководство).

KAMEROVÉ SYSTÉMY / CAMERA SYSTEMS / KAMERASYSTEME / СИСТЕМЫ ВИДЕОНАБЛЮДЕНИЯ



KÓD / ORDER CODE / BESTELL NR. / КОД	POPIS / DESCRIPTION / BESCHREIBUNG / ОПИСАНИЕ
727947	<ul style="list-style-type: none"> ■ KIT obsahuje: 1x 7" zrcadlový monitor s barevným displejem a dvěma vstupními kanály (+CZ manuál, dálkový ovladač, sluneční clona); 1x vodotěsná a prachuvzdorná couvací kamera s nočním viděním a vytápěním (+CZ manuál); 1x propojovací kabel délky 10 m (typ kabelu: aviation). ■ KIT contains: 1x 7" color mirror monitor with 2 input channels (+operation manual, remote control); 1x waterproof&dustproof camera with night vision and heating (+operation manual); 1x connecting cable 10 m (aviation type). ■ KIT enthalten: 1x 7" Spiegel-Farbmonitor mit 2 Eingangskanälen (+Bedienungsanleitung, Fernbedienung, Sonnenblende); 1x wasserdicht und staubdicht Kamera mit Nachtsicht und Heizung (+Bedienungsanleitung); 1x Verbindungskabel 10 m (Aviation typ). ■ KIT содержит: 1x 7-дюймовый цветной монитор с 2 входными каналами (+ руководство по эксплуатации, дистанционное управление), 1x водонепроницаемая и пылезащитная камера с ночным видением и обогревом (+ руководство по эксплуатации), 1x соединительный кабель 10 м (Тип кабеля: авиация).



MONITOR / MONITOR / FARBMONITOR / МОНИТОР

727950



KAMERA / CAMERA / SKAMERA / КАМЕРА

727955



KÓD / ORDER CODE / BESTELL NR. / КОД	POPIS / DESCRIPTION / BESCHREIBUNG / ОПИСАНИЕ				
727950	<table border="0"> <tr> <td> <ul style="list-style-type: none"> ■ Vstup: 2 kanály ■ Obrazovka: 7" TFT-LCD ■ Obraz: 16:9 širokoúhľý / 4:3 ■ Rozlíšení: 800x480 R.G.B. ■ Barevný obraz: ano ■ Napájení: 12V ■ Zapnutí při couvání: automaticky ■ Reproduktor: ne ■ Dotykové ovládání: ano ■ Dálk. ovládání: ano </td> <td> <ul style="list-style-type: none"> ■ Video Input: 2 channels ■ Screen size: 7" TFT-LCD ■ Type: 16:9 wide screen / 4:3 ■ Resolution: 800x480 RGB ■ Color: yes ■ Power supply: 12V ■ Reverse trigger: automatically ■ Speaker: no ■ Touch key: yes ■ Remote control: yes </td> <td> <ul style="list-style-type: none"> ■ Video-Eingang: 2 Kanalän ■ Bildschirmgröße: 7" TFT-LCD ■ Typ: 16:9 breite Bildschirm / 4:3 ■ Lösung: 800x480 RGB ■ Farbbild: Ja ■ Energieversorgung: 12V ■ Schalten beim Rückwärtsfahren: automatisch ■ Redner: nein ■ Taste drücken: ja ■ Fernbedienung: ja </td> <td> <ul style="list-style-type: none"> ■ Видео вход: 2 канала ■ Размер экрана: 7 TFT-LCD ■ Тип: 16:9 Широкий экран / 4: 3 ■ Разрешение: 800x480 RGB ■ Цвет: да ■ Питание: 12V ■ Обратный триггер: Автоматически ■ Докладчик: нет ■ Сенсорный ключ: да ■ Пульт дистанционного управления: да </td> </tr> </table>	<ul style="list-style-type: none"> ■ Vstup: 2 kanály ■ Obrazovka: 7" TFT-LCD ■ Obraz: 16:9 širokoúhľý / 4:3 ■ Rozlíšení: 800x480 R.G.B. ■ Barevný obraz: ano ■ Napájení: 12V ■ Zapnutí při couvání: automaticky ■ Reproduktor: ne ■ Dotykové ovládání: ano ■ Dálk. ovládání: ano 	<ul style="list-style-type: none"> ■ Video Input: 2 channels ■ Screen size: 7" TFT-LCD ■ Type: 16:9 wide screen / 4:3 ■ Resolution: 800x480 RGB ■ Color: yes ■ Power supply: 12V ■ Reverse trigger: automatically ■ Speaker: no ■ Touch key: yes ■ Remote control: yes 	<ul style="list-style-type: none"> ■ Video-Eingang: 2 Kanalän ■ Bildschirmgröße: 7" TFT-LCD ■ Typ: 16:9 breite Bildschirm / 4:3 ■ Lösung: 800x480 RGB ■ Farbbild: Ja ■ Energieversorgung: 12V ■ Schalten beim Rückwärtsfahren: automatisch ■ Redner: nein ■ Taste drücken: ja ■ Fernbedienung: ja 	<ul style="list-style-type: none"> ■ Видео вход: 2 канала ■ Размер экрана: 7 TFT-LCD ■ Тип: 16:9 Широкий экран / 4: 3 ■ Разрешение: 800x480 RGB ■ Цвет: да ■ Питание: 12V ■ Обратный триггер: Автоматически ■ Докладчик: нет ■ Сенсорный ключ: да ■ Пульт дистанционного управления: да
<ul style="list-style-type: none"> ■ Vstup: 2 kanály ■ Obrazovka: 7" TFT-LCD ■ Obraz: 16:9 širokoúhľý / 4:3 ■ Rozlíšení: 800x480 R.G.B. ■ Barevný obraz: ano ■ Napájení: 12V ■ Zapnutí při couvání: automaticky ■ Reproduktor: ne ■ Dotykové ovládání: ano ■ Dálk. ovládání: ano 	<ul style="list-style-type: none"> ■ Video Input: 2 channels ■ Screen size: 7" TFT-LCD ■ Type: 16:9 wide screen / 4:3 ■ Resolution: 800x480 RGB ■ Color: yes ■ Power supply: 12V ■ Reverse trigger: automatically ■ Speaker: no ■ Touch key: yes ■ Remote control: yes 	<ul style="list-style-type: none"> ■ Video-Eingang: 2 Kanalän ■ Bildschirmgröße: 7" TFT-LCD ■ Typ: 16:9 breite Bildschirm / 4:3 ■ Lösung: 800x480 RGB ■ Farbbild: Ja ■ Energieversorgung: 12V ■ Schalten beim Rückwärtsfahren: automatisch ■ Redner: nein ■ Taste drücken: ja ■ Fernbedienung: ja 	<ul style="list-style-type: none"> ■ Видео вход: 2 канала ■ Размер экрана: 7 TFT-LCD ■ Тип: 16:9 Широкий экран / 4: 3 ■ Разрешение: 800x480 RGB ■ Цвет: да ■ Питание: 12V ■ Обратный триггер: Автоматически ■ Докладчик: нет ■ Сенсорный ключ: да ■ Пульт дистанционного управления: да 		
727955	<table border="0"> <tr> <td> <ul style="list-style-type: none"> ■ Sensor: 1/4 Sharp CCD ■ Rozlíšení: 420 TV řádků ■ Mikrofon: ne ■ Min. osvětlení 0 LUX ■ Vzd. noční vidění: 10,65 m ■ LED osvětlení: 9 kusů ■ Vodotěsnost: IP68 ■ Pozorovací úhel: 120° ■ Operační teploty: -20°C až +70°C ■ Napájení: 12V z monitoru ■ Vyhřívání: ano </td> <td> <ul style="list-style-type: none"> ■ Sensor: 1/4 Sharp CCD ■ Resolution: 420 TV line ■ Microphone: no ■ Min. illumination: 0 LUX ■ Night vision distance: 10,65 m ■ IR LED: 9 pcs ■ Waterproof: IP68 ■ View angle: 120° ■ Operation temp.: -20°C to +70°C ■ Power supply: 12V from monitor ■ Heating: yes </td> <td> <ul style="list-style-type: none"> ■ Sensor: 1/4 Sharp CCD ■ Lösung: 420 TV line ■ Mikrofon: nein ■ Min. Erleuchtung: 0 LUX ■ Nachtsichtabstand: 10,65 m ■ R LED: 9 Stücke ■ Wasserdicht: IP68 ■ Betrachtungswinkel: 120° ■ Betriebstemperatur: -20°C to +70°C ■ Energieversorgung: 12V aus monitor ■ Heizung: ja </td> <td> <ul style="list-style-type: none"> ■ Сенсор: 1/4 Sharp CCD ■ Разрешение: 420 ТВ линий ■ Микрофон: нет ■ Минимум освещенности: 0 LUX ■ Расстояние ночного видения: 10,65 м ■ IR LED: 9 шт ■ Водонепроницаемость: IP68 ■ Угол обзора: 120 ° ■ Операция темп.: -20 ° С до + 70 ° С ■ Напряжение питания: 12В от монитора ■ Отопление: да </td> </tr> </table>	<ul style="list-style-type: none"> ■ Sensor: 1/4 Sharp CCD ■ Rozlíšení: 420 TV řádků ■ Mikrofon: ne ■ Min. osvětlení 0 LUX ■ Vzd. noční vidění: 10,65 m ■ LED osvětlení: 9 kusů ■ Vodotěsnost: IP68 ■ Pozorovací úhel: 120° ■ Operační teploty: -20°C až +70°C ■ Napájení: 12V z monitoru ■ Vyhřívání: ano 	<ul style="list-style-type: none"> ■ Sensor: 1/4 Sharp CCD ■ Resolution: 420 TV line ■ Microphone: no ■ Min. illumination: 0 LUX ■ Night vision distance: 10,65 m ■ IR LED: 9 pcs ■ Waterproof: IP68 ■ View angle: 120° ■ Operation temp.: -20°C to +70°C ■ Power supply: 12V from monitor ■ Heating: yes 	<ul style="list-style-type: none"> ■ Sensor: 1/4 Sharp CCD ■ Lösung: 420 TV line ■ Mikrofon: nein ■ Min. Erleuchtung: 0 LUX ■ Nachtsichtabstand: 10,65 m ■ R LED: 9 Stücke ■ Wasserdicht: IP68 ■ Betrachtungswinkel: 120° ■ Betriebstemperatur: -20°C to +70°C ■ Energieversorgung: 12V aus monitor ■ Heizung: ja 	<ul style="list-style-type: none"> ■ Сенсор: 1/4 Sharp CCD ■ Разрешение: 420 ТВ линий ■ Микрофон: нет ■ Минимум освещенности: 0 LUX ■ Расстояние ночного видения: 10,65 м ■ IR LED: 9 шт ■ Водонепроницаемость: IP68 ■ Угол обзора: 120 ° ■ Операция темп.: -20 ° С до + 70 ° С ■ Напряжение питания: 12В от монитора ■ Отопление: да
<ul style="list-style-type: none"> ■ Sensor: 1/4 Sharp CCD ■ Rozlíšení: 420 TV řádků ■ Mikrofon: ne ■ Min. osvětlení 0 LUX ■ Vzd. noční vidění: 10,65 m ■ LED osvětlení: 9 kusů ■ Vodotěsnost: IP68 ■ Pozorovací úhel: 120° ■ Operační teploty: -20°C až +70°C ■ Napájení: 12V z monitoru ■ Vyhřívání: ano 	<ul style="list-style-type: none"> ■ Sensor: 1/4 Sharp CCD ■ Resolution: 420 TV line ■ Microphone: no ■ Min. illumination: 0 LUX ■ Night vision distance: 10,65 m ■ IR LED: 9 pcs ■ Waterproof: IP68 ■ View angle: 120° ■ Operation temp.: -20°C to +70°C ■ Power supply: 12V from monitor ■ Heating: yes 	<ul style="list-style-type: none"> ■ Sensor: 1/4 Sharp CCD ■ Lösung: 420 TV line ■ Mikrofon: nein ■ Min. Erleuchtung: 0 LUX ■ Nachtsichtabstand: 10,65 m ■ R LED: 9 Stücke ■ Wasserdicht: IP68 ■ Betrachtungswinkel: 120° ■ Betriebstemperatur: -20°C to +70°C ■ Energieversorgung: 12V aus monitor ■ Heizung: ja 	<ul style="list-style-type: none"> ■ Сенсор: 1/4 Sharp CCD ■ Разрешение: 420 ТВ линий ■ Микрофон: нет ■ Минимум освещенности: 0 LUX ■ Расстояние ночного видения: 10,65 м ■ IR LED: 9 шт ■ Водонепроницаемость: IP68 ■ Угол обзора: 120 ° ■ Операция темп.: -20 ° С до + 70 ° С ■ Напряжение питания: 12В от монитора ■ Отопление: да 		

Important notice: part of other producers are only mentioned for comparison purposes.

**ODRAZKY /
REFLECTORS /
STRAHLER /
СВЕТОТРАЖАТЕЛИ**



ODRAZKY / REFLECTOR / STRAHLER / СВЕТООТРАЖАТЕЛИ



KÓD / ORDER CODE / BESTELL NR. / КОД	ČIRÁ / CLEAR / KLAR / БЕЛАЯ	ORANŽOVÁ / ORANGE / ORANGE / ОРАНЖЕВАЯ	ČERVENÁ / RED / ROT / КРАСНАЯ	ROZMĚR / DIMENSION / DIMENSION / РАЗМЕРНОСТЬ
721545	■			90x40 mm
721546		■		90x40 mm
721547			■	90x40 mm

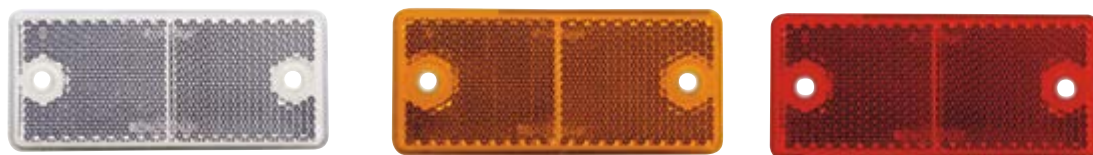

KÓD / ORDER CODE / BESTELL NR. / КОД	ČIRÁ / CLEAR / KLAR / БЕЛАЯ	ORANŽOVÁ / ORANGE / ORANGE / ОРАНЖЕВАЯ	ČERVENÁ / RED / ROT / КРАСНАЯ	ROZMĚR / DIMENSION / DIMENSION / РАЗМЕРНОСТЬ
721355	■			90x40 mm
721354		■		90x40 mm
721356			■	90x40 mm

ODRAZKY / REFLECTOR / STRAHLER / СВЕТООТРАЖАТЕЛИ



KÓD / ORDER CODE / BESTELL NR. / КОД	ČIRÁ / CLEAR / KLAR / БЕЛАЯ	ORANŽOVÁ / ORANGE / ORANGE / ОРАНЖЕВАЯ	ČERVENÁ / RED / ROT / КРАСНАЯ	PRŮMĚR / DIAMETER / DURCHMESSER / ДИАМЕТРЫ
721542	■			Ø 60 mm
721543		■		Ø 60 mm
721544			■	Ø 60 mm





KÓD / ORDER CODE / BESTELL NR. / КОД	ČIRÁ / CLEAR / KLAR / БЕЛАЯ	ORANŽOVÁ / ORANGE / ORANGE / ОРАНЖЕВАЯ	ČERVENÁ / RED / ROT / КРАСНАЯ	PRŮMĚR / DIAMETER / DURCHMESSER / ДИАМЕТРЫ
720069	■			Ø 80 mm
721336		■		Ø 80 mm
721511			■	Ø 80 mm

ODRAZKY / REFLECTOR / STRAHLER / СВЕТООТРАЖАТЕЛИ

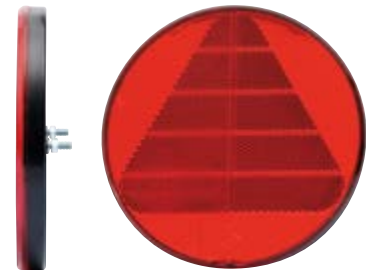

KÓD / ORDER CODE / BESTELL NR. / КОД	ČIRÁ / CLEAR / KLAR / БЕЛАЯ	ORANŽOVÁ / ORANGE / ORANGE / ОРАНЖЕВАЯ	ČERVENÁ / RED / ROT / КРАСНАЯ	PRŮMĚR / DIAMETER / DURCHMESSER / ДИАМЕТРЫ
720071	■			Ø 60 mm
721340		■		Ø 60 mm
721339			■	Ø 60 mm

KÓD / ORDER CODE / BESTELL NR. / КОД	POPIS / DESCRIPTION / BESCHREIBUNG / ОПИСАНИЕ
726814	 <ul style="list-style-type: none"> ■ Červené odrazové sklo (průměr: 145 mm, šířka: 16 mm, upevnění 2x šroub + matice, rozteč: 70 mm) ■ Red reflector (Diameter: 145 mm, Width: 16 mm, Fixing: 2x screws, Distance: 70 mm) ■ Rot Strahler (der Durchschnitt: 145 mm, der Breite: 16 mm, Befestigung: 2x Schrauben der Abstand, Schrauben: 70mm) ■ Стекло светоотражателя - красного цвета (диаметр: 145 мм, толщина: 16 мм, крепление: 2 гайки + болты, шаг/расстояние между болтами: 70 мм)
726757	 <ul style="list-style-type: none"> ■ Červené odrazové sklo (výška: 136 mm, šířka: 6mm) ■ Red reflector (height: 136 mm, width: 6 mm) ■ Rot Strahler (die Höhe: 136 mm, die Breite: 6 mm) ■ Стекло светоотражателя - красного цвета (высота: 136 мм, толщина: 6 мм)



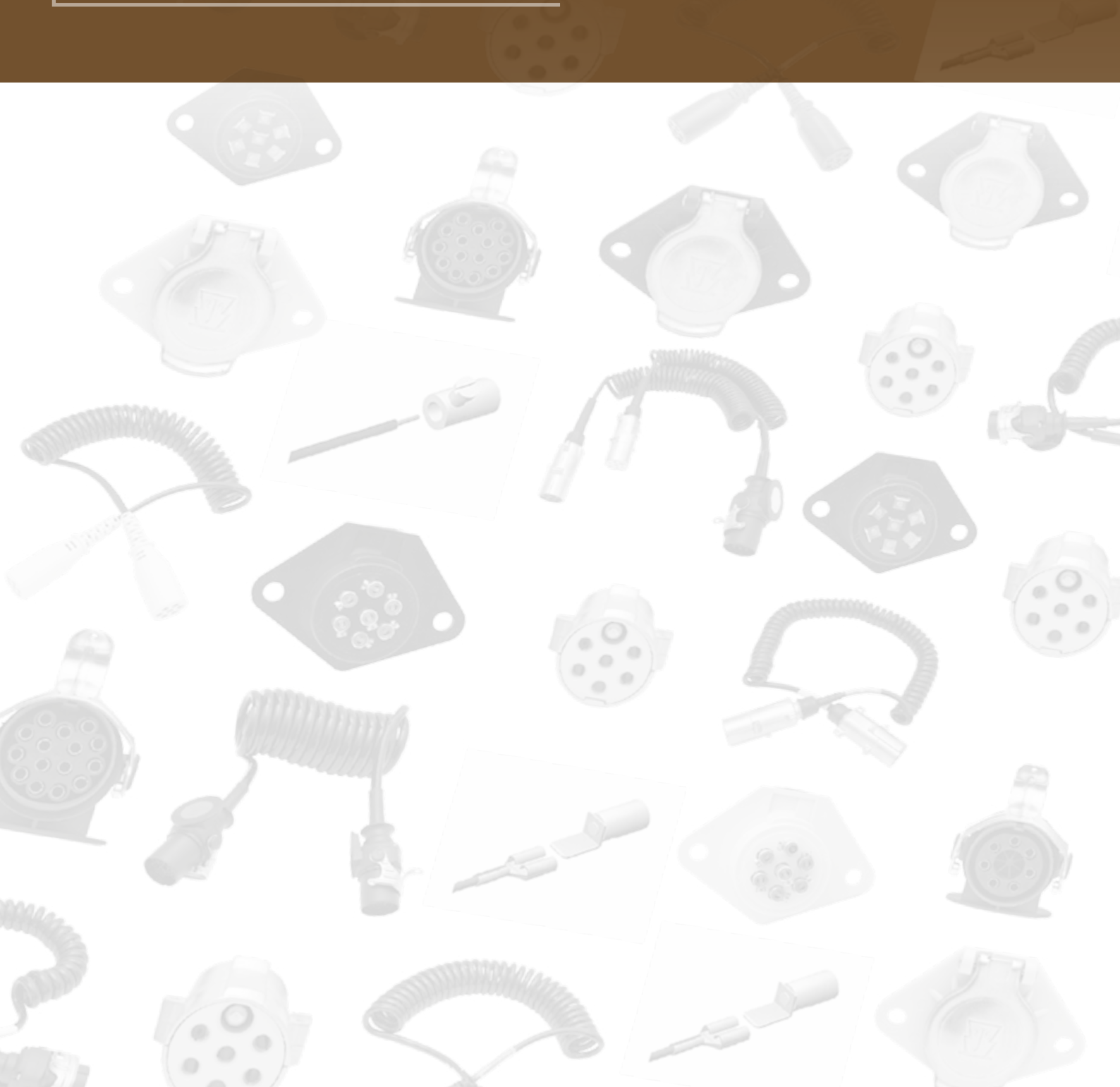













**KABELY - ZÁSUVKY - ZÁSTRČKY /
CABLES - PLUG - SOCKET /
KABEL - STECKER - STECKDOSE /
КАБЕЛИ - РОЗЕТКИ - ВИЛКИ**





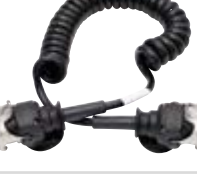









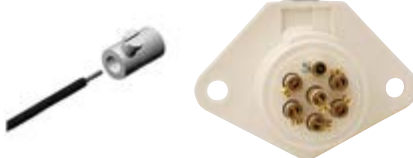

**KABELY - ZÁSUVKY - ZÁSTRČKY / CABLES - PLUG - SOCKET /
KABEL - STECKER - STECKDOSE / КАБЕЛИ - РОЗЕТКИ - ВИЛКИ**

KÓD / ORDER CODE / BESTELL NR. / КОД		POPIS / DESCRIPTION / BESCHREIBUNG / ОПИСАНИЕ
721802		<ul style="list-style-type: none"> ■ 3 m, 2 x 5 pinů + 1 x 7 pinů ■ 3 m, 2 x 5 pins + 1 x 7 pins ■ 3 m, 2 x 5 pin + 1 x 7 pin ■ 3 м, 2 x 5 pin + 1 x 7 pin
721797		<ul style="list-style-type: none"> ■ 5 m, 2 x 5 pinů + 1 x 7 pinů ■ 5 m, 2 x 5 pins + 1 x 7 pins ■ 5 m, 2 x 5 pin + 1 x 7 pin ■ 5 м, 2 x 5 pin + 1 x 7 pin
721799		<ul style="list-style-type: none"> ■ 7 m, 2 x 5 pinů + 1 x 7 pinů ■ 7 m, 2 x 5 pins + 1 x 7 pins ■ 7 m, 2 x 5 pin + 1 x 7 pin ■ 7 м, 2 x 5 pin + 1 x 7 pin
721793		<ul style="list-style-type: none"> ■ 7 m, 2 x 5 pinů + 1 x 13 pinů ■ 7 m, 2 x 5 pins + 1 x 13 pins ■ 7 m, 2 x 5 pin + 1 x 13 pin ■ 7 м, 2 x 5 pin + 1 x 13 pin
721114		<ul style="list-style-type: none"> ■ 10 m, 2 x 7 pinů + 2 x NW10 ■ 10 m, 2 x 7 pins + 2 x NW10 ■ 10 m, 2 x 7 pin + 2 x NW10 ■ 10 м, 2 x 7 pin + 2 x NW10

**KABELY - ZÁSUVKY - ZÁSTRČKY / CABLES - PLUG - SOCKET /
KABEL - STECKER - STECKDOSE / КАБЕЛИ - РОЗЕТКИ - ВИЛКИ**

KÓD / ORDER CODE / BESTELL NR. / КОД		POPIS / DESCRIPTION / BESCHREIBUNG / ОПИСАНИЕ	OE / OE NUMBER / OE NUMMER / OE	NÁKRES / DRAWING / ZEICHNUNG / ЧЕРТЁЖ
723112		<ul style="list-style-type: none"> ■ 4,5 m, N, plastový, 7 pólů ■ 4,5 m, N, plastic, 7x poles ■ 4,5 m, N, plastic, 7x pole ■ 4,5 м, пластмасса, 7 полюсные 		
723114		<ul style="list-style-type: none"> ■ 4,5 m, N, plastový, 7 pólů ■ 4,5 m, N, plastic, 7x poles ■ 4,5 m, N, plastic, 7x pole ■ 4,5 м, пластмасса, 7 полюсные 		
723110		<ul style="list-style-type: none"> ■ 4,5 m, N, kovový, 7 pólů ■ 4,5 m, N, metal, 7x poles ■ 4,5 m, N, metal, 7x pole ■ 4,5 м, металл, 7 полюсные 		
723111		<ul style="list-style-type: none"> ■ 4,5 m, N, kovový, 7 pólů ■ 4,5 m, N, metal, 7x poles ■ 4,5 m, N, metal, 7x pole ■ 4,5 м, металл, 7 полюсные 		
723148		<ul style="list-style-type: none"> ■ 4,5 m, PO, 15 pólů ■ 4,5 m, PO, 15x poles ■ 4,5 m, PO, 15x pole ■ 4,5 м, PO, 15 полюсные 		
723118		<ul style="list-style-type: none"> ■ 4,5 m, 2 x 7 + 1 x 15 pólů ■ 4,5 m, 2 x 7 + 1 x 15 poles ■ 4,5 m, 2 x 7 + 1 x 15 pole ■ 4,5 м, 2 x 7 + 1 x 15 полюсные 		
723116		<ul style="list-style-type: none"> ■ 4,5 m, 5 pólů, ABS ■ 4,5 m, 5 poles, ABS ■ 4,5 m, 5 pole, ABS ■ 4,5 м, 5 полюсные, ABS 		
723182		<ul style="list-style-type: none"> ■ 4,5 m, 7 pólů, EBS ■ 4,5 m, 7 poles, EBS ■ 4,5 m, 7 pole, EBS ■ 4,5 м, 7 полюсные, EBS 		

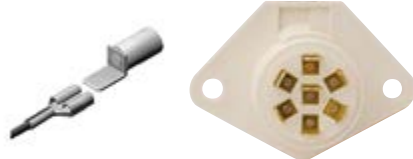

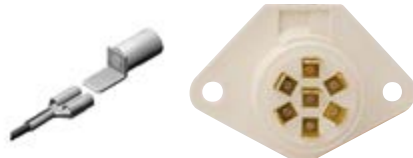











**KABELY - ZÁSUVKY - ZÁSTRČKY / CABLES - PLUG - SOCKET /
KABEL - STECKER - STECKDOSE / КАБЕЛИ - РОЗЕТКИ - ВИЛКИ**

KÓD / ORDER CODE / BESTELL NR. / КОД		POPIS / DESCRIPTION / BESCHREIBUNG / ОПИСАНИЕ	NÁKRES / DRAWING / ZEICHNUNG / ЧЕРТЁЖ
723107		<ul style="list-style-type: none"> ■ N, plastový ■ N, plastic ■ N, plastic ■ N, пластмасса 	
723103		<ul style="list-style-type: none"> ■ N, kovový ■ N, metal ■ N, metal ■ N, металл 	
723106		<ul style="list-style-type: none"> ■ S, plastový ■ S, plastic ■ S, plastic ■ S, пластмасса 	
723102		<ul style="list-style-type: none"> ■ S, kovový ■ S, metal ■ S, metal ■ S, металл 	
723109		<ul style="list-style-type: none"> ■ N, plastový ■ N, plastic ■ N, plastic ■ N, пластмасса 	
723105		<ul style="list-style-type: none"> ■ N, kovový ■ N, metal ■ N, metal ■ N, металл 	
723108		<ul style="list-style-type: none"> ■ S, plastový ■ S, plastic ■ S, plastic ■ S, пластмасса 	
723104		<ul style="list-style-type: none"> ■ S, kovový ■ S, metal ■ S, metal ■ S, металл 	

KABELY - ZÁSUVKY - ZÁSTRČKY / CABLES - PLUG - SOCKET / KABEL - STECKER - STECKDOSE / КАБЕЛИ - РОЗЕТКИ - ВИЛКИ

KÓD / ORDER CODE / BESTELL NR. / КОД		POPIS / DESCRIPTION / BESCHREIBUNG / ОПИСАНИЕ	OE / OE NUMBER / OE NUMMER / OE	NÁKRES / DRAWING / ZEICHNUNG / ЧЕРТЁЖ
723061		<ul style="list-style-type: none"> ■ N, plastový ■ N, plastic ■ N, plastic ■ N, пластмасса 		
723101		<ul style="list-style-type: none"> ■ N, kovový ■ N, metal ■ N, metal ■ N, металл 		
723060		<ul style="list-style-type: none"> ■ S, plastový ■ S, plastic ■ S, plastic ■ S, пластмасса 		
723100		<ul style="list-style-type: none"> ■ S, kovový ■ S, metal ■ S, metal ■ S, металл 		
723059		<ul style="list-style-type: none"> ■ N, plastový ■ N, plastic ■ N, plastic ■ N, пластмасса 		
723093		<ul style="list-style-type: none"> ■ N, kovový ■ N, metal ■ N, metal ■ N, металл 		
723058		<ul style="list-style-type: none"> ■ S, plastový ■ S, plastic ■ S, plastic ■ S, пластмасса 		
723090		<ul style="list-style-type: none"> ■ S, kovový ■ S, metal ■ S, metal ■ S, металл 		

KABELY - ZÁSUVKY - ZÁSTRČKY / CABLES - PLUG - SOCKET / KABEL - STECKER - STECKDOSE / КАБЕЛИ - РОЗЕТКИ - ВИЛКИ

KÓD / ORDER CODE / BESTELL NR. / КОД		POPIS / DESCRIPTION / BESCHREIBUNG / ОПИСАНИЕ	NÁKRES / DRAWING / ZEICHNUNG / ЧЕРТЁЖ
723072		<ul style="list-style-type: none"> ■ 7 pinů, polů, EBS, plastový ■ 7 pins, poles, EBS, plastic ■ 7 pins, pole, EBS, plastic ■ 7 pin / Полюсы, EBS, пластмасса 	
723138		<ul style="list-style-type: none"> ■ 7 pinů, polů, EBS, plastový ■ 7 pins, poles, EBS, plastic ■ 7 pins, pole, EBS, plastic ■ 7 pin / Полюсы, EBS, пластмасса 	
723080		<ul style="list-style-type: none"> ■ 7 pinů, polů, EBS, plastový ■ 7 pins, poles, EBS, plastic ■ 7 pins, pole, EBS, plastic ■ 7 pin / Полюсы, EBS, пластмасса 	
723140		<ul style="list-style-type: none"> ■ 7 pinů, polů, EBS, plastový ■ 7 pins, poles, EBS, plastic ■ 7 pins, pole, EBS, plastic ■ 7 pin / Полюсы, EBS, пластмасса 	
723077		<ul style="list-style-type: none"> ■ 5 pinů, polů, EBS, plastový ■ 5 pins, poles, EBS, plastic ■ 5 pins, pole, EBS, plastic ■ 5 pin / Полюсы, EBS, пластмасса 	
723135		<ul style="list-style-type: none"> ■ 5 pinů, polů, EBS, plastový ■ 5 pins, poles, EBS, plastic ■ 5 pins, pole, EBS, plastic ■ 5 pin / Полюсы, EBS, пластмасса 	
723081		<ul style="list-style-type: none"> ■ 5 pinů, polů, EBS, plastový ■ 5 pins, poles, EBS, plastic ■ 5 pins, pole, EBS, plastic ■ 5 pin / Полюсы, EBS, пластмасса 	
723137		<ul style="list-style-type: none"> ■ 5 pinů, polů, EBS, plastový ■ 5 pins, poles, EBS, plastic ■ 5 pins, pole, EBS, plastic ■ 5 pin / Полюсы, EBS, пластмасса 	

KABELY - ZÁSUVKY - ZÁSTRČKY / CABLES - PLUG - SOCKET / KABEL - STECKER - STECKDOSE / КАБЕЛИ - РОЗЕТКИ - ВИЛКИ

KÓD / ORDER CODE / BESTELL NR. / КОД		POPIS / DESCRIPTION / BESCHREIBUNG / ОПИСАНИЕ	OE / OE NUMBER / OE NUMMER / OE	NÁKRES / DRAWING / ZEICHNUNG / ЧЕРТЁЖ
723133		<ul style="list-style-type: none"> ■ 15 pinů, polů, plastový ■ 15 pins, poles, plastic ■ 15 pins, pole, plastic ■ 15 pin / Полюсы, пластмасса 		
723132		<ul style="list-style-type: none"> ■ 15 pinů, polů, plastový ■ 15 pins, poles, plastic ■ 15 pins, pole, plastic ■ 15 pin / Полюсы, пластмасса 		
723099		<ul style="list-style-type: none"> ■ 15 pinů, polů, plastový ■ 15 pins, poles, plastic ■ 15 pins, pole, plastic ■ 15 pin / Полюсы, пластмасса 		
723134		<ul style="list-style-type: none"> ■ 15 pinů, polů, plastový ■ 15 pins, poles, plastic ■ 15 pins, pole, plastic ■ 15 pin / Полюсы, пластмасса 		
KÓD / ORDER CODE / BESTELL NR. / КОД		POPIS / DESCRIPTION / BESCHREIBUNG / ОПИСАНИЕ	OE / OE NUMBER / OE NUMMER / OE	NÁKRES / DRAWING / ZEICHNUNG / ЧЕРТЁЖ
720590		<ul style="list-style-type: none"> ■ 2 x 25 A + 1 x 5 A, 3 piny / poly ■ 2 x 25 A + 1 x 5 A, 3 pins / poles ■ 2 x 25 A + 1 x 5 A, 3 pins / pole ■ 2 x 25 A + 1 x 5 A, 3 pin / Полюсы 		
720591		<ul style="list-style-type: none"> ■ 2 x 25 A + 1 x 5 A, 3 piny / poly ■ 2 x 25 A + 1 x 5 A, 3 pins / poles ■ 2 x 25 A + 1 x 5 A, 3 pins / pole ■ 2 x 25 A + 1 x 5 A, 3 pin / Полюсы 		
KÓD / ORDER CODE / BESTELL NR. / КОД		POPIS / DESCRIPTION / BESCHREIBUNG / ОПИСАНИЕ	OE / OE NUMBER / OE NUMMER / OE	NÁKRES / DRAWING / ZEICHNUNG / ЧЕРТЁЖ
723119		<ul style="list-style-type: none"> ■ 1 x 15 A + 2 x 7 A, 3 pinů / polů ■ 1 x 15 A + 2 x 7 A, 3 pins / poles ■ 1 x 15 A + 2 x 7 A, 3 pins / pole ■ 1 x 15 A + 2 x 7 A, 3 pin / Полюсы 		

**BOX NA HASÍČÍ PŘÍSTROJ, ZAKLÁDACÍ KLÍN / FIRE EXTINGUISHER BOX, WHEEL CHOCK /
FEUERLÖSCHER BOX, UNTERLEGKEIL / ЯЩИК ДЛЯ ОГнетушИТЕЛЯ, ПОДКЛАДНАЯ КОЛОДКА ПОД КОЛЕСА**

KÓD / ORDER CODE / BESTELL NR. / КОД		POPIS / DESCRIPTION / BESCHREIBUNG / ОПИСАНИЕ	OE / OE NUMBER / OE NUMMER / OE	NÁKRES / DRAWING / ZEICHNUNG / ЧЕРТЁЖ
725756		6 / 9 kg		670 x 260 x 240 mm
KÓD / ORDER CODE / BESTELL NR. / КОД		POPIS / DESCRIPTION / BESCHREIBUNG / ОПИСАНИЕ	OE / OE NUMBER / OE NUMMER / OE	NÁKRES / DRAWING / ZEICHNUNG / ЧЕРТЁЖ
725755		6 / 9 kg		670 x 260 x 240 mm

OBSAH / INDEX / INHALT / СОДЕРЖАНИЕ

KÓD / ORDER CODE / BESTELL NR. / КОД	STRANA / PAGE / SEITE / СТРАНИЦА	KÓD / ORDER CODE / BESTELL NR. / КОД	STRANA / PAGE / SEITE / СТРАНИЦА	KÓD / ORDER CODE / BESTELL NR. / КОД	STRANA / PAGE / SEITE / СТРАНИЦА
720002	28	720241	101	720550	234
720003	28	720242	103	720553	234
720006	171	720244	58	720554	78
720007	28	720247	148	720554/N	78
720008	28	720248	148	720555	234
720009	28	720249	148	720557	78
720010	170	720250	50	720557/N	78
720015	49	720251	149	720563	202
720016	49	720252	149	720577	134
720017	101	720254	179	720578	134
720019	134	720255	179	720590	261
720021	49	720258	15, 102	720591	261
720024	28	720259	15, 102	720592	91
720025	28	720261	187	720595	91
720026	28	720264	75	720606	183
720031	31	720330	47	720607	183
720042	46	720343	39	720785	197
720043	46	720347	89	720786	197
720046	55	720348	89	720830	218
720047	55	720371	162	721032	17, 18, 81, 84, 96, 97
720054	28	720381	220	721059	18, 81, 97, 98
720058	162	720382	136	721069	63, 64, 66, 68, 69, 133
720069	253	720383	136	721111	29
720071	254	720385	220	721114	256
720073	56	720387	220	721115	29
720076	56	720388	220	721120	29
720080	60	720389	220	721121	29
720083	60	720391	220	721122	29
720100	16, 94	720392	220	721123	29
720112	171	720411	179	721160	139
720120	94	720458	191	721161	139
720121	94	720470	187	721164	138, 139
720126	58	720474	161, 171, 185, 188	721165	138, 139
720141	16, 94	720476	233	721166	138
720142	16, 94	720477	161, 171, 185, 188	721167	138
720168	55	720478	161, 171, 185, 188	721194	125
720169	55	720483	233	721195	125
720170	56	720484	233	721196	125
720171	55	720511	139, 140	721197	125
720176	121	720514	140	721198	125
720177	121	720515	140	721223	131
720178	121	720516	140	721224	131
720179	121	720517	140	721225	131
720218	15, 102	720538	154, 155, 156, 157, 158, 159	721226	131
720224	49	720544	202	721262	132
720226	50	720549	50	721263	132

OBSAH / INDEX / INHALT / СОДЕРЖАНИЕ

KÓD / ORDER CODE / BESTELL NR. / КОД	STRANA / PAGE / SEITE / СТРАНИЦА	KÓD / ORDER CODE / BESTELL NR. / КОД	STRANA / PAGE / SEITE / СТРАНИЦА	KÓD / ORDER CODE / BESTELL NR. / КОД	STRANA / PAGE / SEITE / СТРАНИЦА
721264	132	721567	137	721776	113
721265	132	721568	137	721777	113
721272	170	721569	137	721778	113
721275	82	721570	137	721779	113
721276	82	721571	137	721780	113
721280	121	721572	174	721781	113
721281	121	721582	177	721788	108,109,110,111,112,113, 114,115,116,117,118,119,120
721281	121	721589	173	721789	108,109,110,111,112,113, 114,115,116,117,118,119,120
721289	175	721594	174	721793	256
721302	175	721595	166	721797	256
721304	187	721599	165	721799	256
721311	191	721602	173	721800	122, 123
721336	253	721607	177	721801	122, 123
721339	254	721613	54	721802	256
721340	254	721616	173	721804	175
721354	252	721631	174	721805	202
721355	252	721632	213	721807	167
721356	252	721633	213	721826	210
721360	193	721635	177	721827	210
721361	194	721636	173	721840	165
721370	209	721638	166	721841	165
721371	209	721640	174	721842	178
721372	209	721646	165	721843	178
721381	208	721647	169	721844	167
721389	214	721650	169	721845	167
721391	214	721651	214	721870	211
721427	214	721652	169	721871	211
721465	162	721653	214	721872	211
721466	162	721656	198	721873	211
721468	161, 163, 171, 182, 185, 186, 187, 188, 189, 190, 191, 192, 193, 194, 195, 196, 198, 199, 202, 205, 214, 218	721657	169	721874	211
721493	121, 134, 135, 136, 137, 150	721726	152	721875	210
721511	253	721730	152	721876	210
721531	181, 182	721754	129	721877	210
721532	181, 182	721755	129	721878	210
721542	253	721756	129	721880	199
721543	253	721757	129	721881	202
721544	253	721758	129	721882	206
721545	252	721759	129	721885	200
721546	252	721760	122, 123, 125, 126, 127, 128, 129, 130, 131, 132	721886	204
721547	252	721761	122, 123, 125, 126, 127, 128, 129, 130, 131, 132	721887	204
721562	213	721769	113	721893	109
721563	213	721770	113	721908	216
721564	213	721771	113	721909	216
		721774	113	721945	216

KÓD / ORDER CODE / BESTELL NR. / КОД	STRANA / PAGE / SEITE / СТРАНИЦА	KÓD / ORDER CODE / BESTELL NR. / КОД	STRANA / PAGE / SEITE / СТРАНИЦА	KÓD / ORDER CODE / BESTELL NR. / КОД	STRANA / PAGE / SEITE / СТРАНИЦА
721954	166	722227	95	722716	149
721969	184	722228	119	722718	149
721970	187	722229	16, 98	722764	192
721971	184	722234	83	722772	100
721972	192	722235	83	722773	100
721973	184	722236	83	722817	24
721974	194	722237	83	722818	24
722007	127	722252	91	722837	170
722009	127	722253	91	722883	135
722010	127	722254	91	722884	135
722011	127	722255	91	722932	148
722014	128	722260	95, 155	722944	148
722015	128	722261	95, 155	722972	90
722016	128	722297	100	723049	218
722017	130	722298	100	723051	217
722019	130	722299	100	723052	218
722020	130	722300	100	723053	156, 157, 158, 159
722022	130	722301	120	723058	259
722030	174	722304	82	723059	259
722031	174	722305	82	723060	259
722060	149	722354	3	723061	259
722061	149	722355	3	723062	14, 99
722063	149	722364	23	723062/N	14, 99
722065	150	722365	23	723063	14, 99
722066	150	722366	24	723063/N	14, 99
722067	150	722404	103	723064	103
722068	150	722525	191	723065	103
722078	212	722529	186, 190, 193	723066	103
722079	212	722549	114	723072	260
722080	212	722602	143	723077	260
722109	92	722604	143	723080	260
722115	115	722607	141	723081	260
722116	115	722608	142	723090	259
722121	114	722609	142	723093	259
722124	115	722610	142, 143	723099	261
722134	92	722615	141	723100	259
722136	112	722616	144	723101	259
722139	92	722617	144	723102	258
722140	92	722621	144	723103	258
722149	92	722622	144	723104	258
722180	192	722623	141	723105	258
722181	192	722627	144	723106	258
722220	76	722628	144	723107	258
722221	92	722632	141	723108	258
722223	76	722636	141	723109	258
722226	95	722679	136	723110	257

OBSAH / INDEX / INHALT / СОДЕРЖАНИЕ

KÓD / ORDER CODE / BESTELL NR. / КОД	STRANA / PAGE / SEITE / СТРАНИЦА	KÓD / ORDER CODE / BESTELL NR. / КОД	STRANA / PAGE / SEITE / СТРАНИЦА	KÓD / ORDER CODE / BESTELL NR. / КОД	STRANA / PAGE / SEITE / СТРАНИЦА
723111	257	723800	226	723876	235
723112	257	723802	226	723876/KM	235
723114	257	723803	223	723877	235
723116	257	723804	223	723877/KM	235
723118	257	723807	224	723878	235
723119	261	723808	225	723878/KM	235
723132	261	723809	224	723879	235
723133	261	723810	224	723879/KM	235
723134	261	723811	225	723925	232
723135	260	723812	227	723969	193
723137	260	723813	227	723970	193
723138	260	723820	227	723971	124
723140	260	723821	227	723979	124
723148	257	723822	227	723980	124
723150	198	723823	227	723981	124
723182	257	723824	227	723982	161
723410	233	723825	227	723983	163
723414	233	723826	227	723984	161
723416	233	723827	227	723985	161
723659	38	723828	227	723986	161
723660	38	723829	227	723987	161
723661	38	723830	227	723992	185
723662	38	723831	227	723993	236
723726	221	723833	223	723994	236
723728	221	723861	237	723995	236
723730	221	723862	237	723996	236
723731	221	723863	237	723997	236
723749	222	723864	237	723998	236
723752	222	723865	238	723999	236
723753	222	723866	238	724000	236
723754	222	723867	238	724001	236
723755	222	723868	238	724002	236
723758	231	723869	235	724004	239
723763	228	723869/KM	235	724005	236
723776	61	723870	235	724018	186
723777	61	723870/KM	235	724019	193
723785	229	723871	235	724024	171
723786	229	723871/KM	235	724027	171
723787	228	723872	235	724044	188
723788	230	723872/KM	235	724045	188
723789	231	723873	235	724049	189
723790	231	723873/KM	235	724050	191
723791	230	723874	235	724051	190
723792	230	723874/KM	235	724052	190
723794	228	723875	235	724112	195
723795	229	723875/KM	235	724114	195

OBSAH / INDEX / INHALT / СОДЕРЖАНИЕ

KÓD / ORDER CODE / BESTELL NR. / КОД	STRANA / PAGE / SEITE / СТРАНИЦА	KÓD / ORDER CODE / BESTELL NR. / КОД	STRANA / PAGE / SEITE / СТРАНИЦА	KÓD / ORDER CODE / BESTELL NR. / КОД	STRANA / PAGE / SEITE / СТРАНИЦА
724120	190	724602	156	725082	133
724123	195	724603	157	725145	189
724123	196	724604	157	725165	189
724131	195	724605	158	725194	47
724147	196	724606	158	725201	107
724148	196	724607	159	725202	25, 106
724155	195	724608	159	725203	25, 106
724162	195	724609	17, 97	725204	107
724167	195	724610	18, 97	725205	25, 106, 107
724194	218	724611	18, 96	725206	25, 106, 107
724194 / N	218	724612	9, 81	725207	25, 106
724195	215	724613	10, 81	725208	25, 106
724203	196	724614	10, 80	725209	25, 106
724204	196	724615	17, 96	725210	25, 106
724206	215	724616	9, 79	725279	89
724311	206	724617	9, 79	725280	171
724318	199	724618	79	725386	181
724320	199	724619	17, 96	725387	181
724321	206	724620	155, 156, 157, 158, 159	725504	180
724326	200	724621	155, 156, 157, 158, 159	725505	180
724327	204	724622	155, 156, 157, 158, 159	725506	124, 141, 142, 143, 144, 145, 146, 147
724328	206	724687	8, 79	725520	143, 180
724329	200	724688	186	725521	143, 180
724329	204	724698	86	725522	180
724334	200	724823	145	725523	180
724335	202	724831	145	725539	186
724336	199	724832	145	725540	186
724352	104	724833	145	725560	126
724353	104	724835	146	725561	126
724354	104	724836	146	725562	126
724355	104	724840	145, 146	725563	126
724358	105	724842	145, 147	725564	126
724359	105	724846	147	725569	122
724360	16, 80, 98, 104, 105, 133	724847	147	725570	122
724532	112, 156	724858	32	725571	122
724533	108	724859	32	725573	122
724534	108	724863	124	725574	122
724590	110	724864	124	725576	122
724591	110	724876	70	725578	123
724592	111	724889	71	725579	123
724593	111	724961	166	725580	123
724597	154	725077	133	725581	123
724598	154	725078	133	725652	19
724599	155	725079	133	725652	58
724600	155	725080	133	725653	19, 58
724601	156	725081	133		

OBSAH / INDEX / INHALT / СОДЕРЖАНИЕ

KÓD / ORDER CODE / BESTELL NR. / КОД	STRANA / PAGE / SEITE / СТРАНИЦА	KÓD / ORDER CODE / BESTELL NR. / КОД	STRANA / PAGE / SEITE / СТРАНИЦА	KÓD / ORDER CODE / BESTELL NR. / КОД	STRANA / PAGE / SEITE / СТРАНИЦА
725654	49	726550	194	726887	11, 77
725655	51	726659	189	726888	11, 77
725656	56	726661	185	726890	30
725680	59	726664	189	726891	30
725681	59	726723	208	726892	30
725690	51	726724	208	726893	30
725691	56	726725	208	726895	13, 93
725692	57	726729	208	726896	13, 93
725693	57	726734	70	726911	67
725694	57	726735	117	726912	67
725755	262	726736	116	726953	185
725756	262	726737	116	726955	190
725828	120	726757	157, 254	726956	188
725911	203	726775	47	726961	198, 205
725952	203	726801	67	726962	191
725953	203	726802	67	726963	190
725954	203	726803	67	726964	205
725970	201	726804	98	726965	188
725979	203	726814	254	726966	198
725980	117	726815	8, 80	726978	191
725997	201	726818	182	726983	170
725998	204	726819	182	726984	170
725999	207	726820	181	726985	170
726005	207	726821	181	726992	189
726006	207	726822	182	726993	198
726007	207	726823	181	726996	189
726008	34	726824	181	726999	151
726009	201	726825	181	727006/N	151
726010	201, 203, 204, 207	726857	164, 168, 172, 176	727009	119
726047	37	726858	164, 168, 172, 176	727013	215
726051	36	726859	164, 168, 172, 176	727110	72
726052	36	726860	164, 168, 172, 176	727112	72
726053	36	726861	176	727114	73
726057	37	726862	164	727115	65
726070	37	726864	164	727116	65
726071	36	726865	168	727120	73
726097	42	726866	176	727123	75
726098	42	726867	172	727125	88
726099	42	726870	13, 93	727126	88
726101	44	726871	13, 93	727127	66
726102	44	726872	13, 93	727128	66
726103	45	726873	13, 93	727129	88
726105	45	726875	31	727131	66
726110	43	726876	31	727132	66
726111	43	726877	32	727135	71
726541	217	726878	32	727136	53

OBSAH / INDEX / INHALT / СОДЕРЖАНИЕ

KÓD / ORDER CODE / BESTELL NR. / КОД	STRANA / PAGE / SEITE / СТРАНИЦА	KÓD / ORDER CODE / BESTELL NR. / КОД	STRANA / PAGE / SEITE / СТРАНИЦА	KÓD / ORDER CODE / BESTELL NR. / КОД	STRANA / PAGE / SEITE / СТРАНИЦА
727137	53	727390	39	728369	63
727139	53	727391	39	728372	51
727140	53	727431	33	728377	6
727141	54	727432	34	728378	7
727149	20, 52	727433	33	728379	68
727151	4, 52	727434	34	728380	64
727152	5	727435	46	728381	64
727155	5	727436	46	728382	68
727156	65	727445	35	728383	68
727157	84	727446	35	728384	3
727158	84	727447	35	728385	3
727159	22, 85	727450	35	728386	4
727160	22, 85	727451	41	728388	7
727161	85, 86	727452	41	728389	6
727162	85	727453	41	728390	22
727163	85	727455	46	728391	22
727164	84, 85	727920	244	728392	12, 86
727179	76	727921	244	728393	12, 86
727182	76	727923	245	728396	69
727183	76	727924	246	728397	69
727191	27	727925	247	728941	83
727192	27	727926	247	728942	83
727193	27	727927	247	728943	83
727195	27	727928	247	729310	101
727196	27	727929	247	729315	40
727197	27	727930	242		
727198	27	727931	241, 242		
727207	179	727936	245		
727235	179	727938	247		
727236	179	727939	243		
727296	217	727940	243		
727297	217	727942	248		
727316	63, 64	727943	248		
727319	65, 70	727947	250		
727326	118	727948	241		
727327	118	727950	250		
727335	105	727955	250		
727336	105	727956	246		
727337	105	728005	249		
727348	216	728218	59		
727379	163	728268	60		
727380	163	728269	60		
727381	177	728270	60		
727386	40	728366	63		
727387	40	728367	63		
727388	39	728368	63		

REJSTŘÍK / CROSS REFERENCE LIST / GEGENÜBERSTELLUNG HERSTELLER / СРАВНИТЕЛЬНАЯ ТАБЛИЦА ОРИГИНАЛЬНЫХ НОМЕРОВ

ZETOR

OE / OE NUMBER / OE NUMBER / OE	KÓD / ORDER CODE / BESTELL NR. / КОД	STRANA / PAGE / SEITE / СТРАНИЦА
15.351.039	726887	11, 77
15.351.049	726887	11, 77
16.351.039	726887	11, 77
16.351.049	726887	11, 77
16.351.129	720258	15, 102
16.351.139	720258	15, 102
19.351.903	27149	20, 52
19.351.908	724617	9, 79
19.351.909	724616	9, 79
53.351.049	728378	7
53.351.049	728388	7
53.351.050	728378	7
53.351.901	720258	15, 102
53.351.917	728389	6
53.351.946	728389	6
55.350.902	727152	5
55.350.904	727151	4, 52
5911-5717	722354	3

OE / OE NUMBER / OE NUMBER / OE	KÓD / ORDER CODE / BESTELL NR. / КОД	STRANA / PAGE / SEITE / СТРАНИЦА
5911-5718	722355	3
6011-5805	726888	11, 77
6011-5805/8	726888	11, 77
6711-5710	726888	11, 77
6711-5711	726872	13, 93
6711-5712	726873	13, 93
78.351.549	726887	11, 77
89-352-903	728386	4
89-352-904	728386	4
93-3254	720218	15, 102
93-5574	728392	12, 86
93-5575	728393	12, 86
93-5576	723063	14, 99
93-5577	725653	19, 58
93-5577	725652	19, 58
97-6716	728385	3
97-6717	728384	3

COBO

OE / OE NUMBER / OE NUMBER / OE	KÓD / ORDER CODE / BESTELL NR. / КОД	STRANA / PAGE / SEITE / СТРАНИЦА
1011301	720554	78
1013194	728390	22
1013199	728391	22
02.0999.0000	725202	25, 106
02.1000.0000	725207	25, 106
02.1156.0000	725203	25, 106
02.1156.0200	725209	25, 106
02.1157.0000	725208	25, 106
02.1157.0200	725210	25, 106
02.1335.0000	724615	17, 96
02.1335.0200	724619	17, 96
02.1339.0000	725201	107
02.1339.0200	725205	25, 106, 107
02.1340.0000	725204	107
02.1340.0200	725206	25, 106, 107
02.1373.0200	720577	134
02.1374.0200	720578	134
02.356.200.01	720592	91
02.394.000	723063	14, 99
02.430.000.01	720595	91

OE / OE NUMBER / OE NUMBER / OE	KÓD / ORDER CODE / BESTELL NR. / КОД	STRANA / PAGE / SEITE / СТРАНИЦА
02.728.000.01	720347	89
02.728.210.01	720348	89
02.748.000.01	725279	89
02.780.000.01	722972	90
03.0557.0000	727160	22, 85
03.0558.0000	727159	22, 85
03.0628.0000	727162	85
03.0629.0000	727163	85
03.0665.0000	724616	9, 79
03.0666.0000	724617	9, 79
03.0676.0000	727158	84
03.0677.0000	727157	84
03.0767.0000	724698	86
03.104.000.01	720554	78
03.387.000.01	727123	75
03.387.100.01	727124	75
03.483.000.01	727125	88
03.483.001	727126	88
05.0918.0000.01	727127	66
05.0919.0000.01	727128	66

REJSTŘÍK / CROSS REFERENCE LIST / GEGENÜBERSTELLUNG HERSTELLER / СРАВНИТЕЛЬНАЯ ТАБЛИЦА ОРИГИНАЛЬНЫХ НОМЕРОВ

COBO

OE / OE NUMBER / OE NUMBER / OE	KÓD / ORDER CODE / BESTELL NR. / КОД	STRANA / PAGE / SEITE / СТРАНИЦА
05.0922.0000.01	727131	66
05.0923.0000.01	727132	66
05.1098.0000	727136	53
05.1154.0000	727139	53
05.1155.0000	727140	53
05.1156.0000	727141	54
05.1193.0000	727151	4, 52
05.1316.0000	727152	5
05.1350.0000	721613	54
05.1392.0000	727155	5
05.160.000.01	727135	71
05.160.600	724889	71
05.1610.0000	727149	20, 52
05.376.000.01	722366	24
05.406.000.53	722364	23
05.420.000.03	722365	23

OE / OE NUMBER / OE NUMBER / OE	KÓD / ORDER CODE / BESTELL NR. / КОД	STRANA / PAGE / SEITE / СТРАНИЦА
05.439.000.01	727110	72
05.478.002	727156	65
05.479.000.01	727115	65
05.483.000.01	727116	65
05.487.000.01	727114	73
05.526.000.01	727120	73
05.619.000.01	724876	70
05.620.000.01	726734	70
25.1099.0000	727137	53
35.400.000.01	726875	31
35.404.000.01	726874	31
35.406.000.01	726876	31
35.408.000.01	726878	32
35.7006.0000.01	727391	39
35.7008.0000.01	727388	39
35.7010.0000.01	727391	39

HELLA

OE / OE NUMBER / OE NUMBER / OE	KÓD / ORDER CODE / BESTELL NR. / КОД	STRANA / PAGE / SEITE / СТРАНИЦА
1AB006213-001	728377	6
1AB006213-001	728389	6
1EA993975-051	726801	67
1EA993975-061	726802	67
2BE003014-251	727123	75
2BE003182-091	728942	83
2BE003182-101	728941	83
2BE003184-051	722235	83
2BE003184-061	722234	83
2BE003185-031	722304	82
2BE343130-001	726815	8, 80
2BE343130-411	724687	8, 79
2BE964169-071	721275	82
2DA964169-001	724358	105
2PS340001 - 001	722180	192
2PS963639 - 011	722181	192
2RL004958-111	721115	29
2RL007550-021	721120	29
2RL007550-021	721121	29
2RL007553-021	721122	29
2SA001259-751	721804	175

OE / OE NUMBER / OE NUMBER / OE	KÓD / ORDER CODE / BESTELL NR. / КОД	STRANA / PAGE / SEITE / СТРАНИЦА
2SB003014-151	727129	89
2SD002776-031	722298	100
2SD002776-241	722297	100
2SD003184-031	722139	92
2SD003184-041	722109	92
2SD343130-011	722229	16, 98
2SD343130-377	726804	98
2SD964169-111	724352	104
2SE002578-701	722226	95
2SE003184-011	722134	92
2SW003185-041	722772	100
2TA964169-061	724354	104
2VP003567-111	720248	148
2VP003567-121	720247	148
2VP340830-021	720514	140
2VP340830-031	720515	140
2VP340930-021	721160	139
2VP340930-031	721161	139
2VP340931-001	721166	138
2VP340931-011	721167	138
2VP343640-021	725077	133

REJSTŘÍK / CROSS REFERENCE LIST / GEGENÜBERSTELLUNG HERSTELLER / СРАВНИТЕЛЬНАЯ ТАБЛИЦА ОРИГИНАЛЬНЫХ НОМЕРОВ

HELLA

OE / OE NUMBER / OE NUMBER / OE	KÓD / ORDER CODE / BESTELL NR. / КОД	STRANA / PAGE / SEITE / СТРАНИЦА
2VP343640-031	725078	133
2VP343640-041	725079	133
2VP343640-051	725080	133
2XS005020-001	721589	173
2XS005020-011	721602	173
2XS005020-021	721616	173
2XS011744-011	720786	197
2XS011744-021	720785	197
9EL115003-055	727124	75
9EL118633-001	722773	100
9EL118700-001	722149	92
9EL118701-001	722140	92
9EL122689-021	720249	148

OE / OE NUMBER / OE NUMBER / OE	KÓD / ORDER CODE / BESTELL NR. / КОД	STRANA / PAGE / SEITE / СТРАНИЦА
9EL132215-001	721636	173
9EL137307-001	722300	100
9EL137308-001	722299	100
9EL146491-001	722227	95
9EL340829-001	720516	140
9EL340829-011	720517	140
9EL340829-021	721164	138, 139
9EL340829-031	721165	138, 139
9EL343142-001	725081	133
9EL343143-001	725082	133
9EL964526-001	724359	105
9EL964532-001	724355	104
9EL964536-001	724353	104

ASPÖCK

OE / OE NUMBER / OE NUMBER / OE	KÓD / ORDER CODE / BESTELL NR. / КОД	STRANA / PAGE / SEITE / СТРАНИЦА
12-1570-001	722628	144
12-1570-101	722627	144
13-0521-044	721760	122, 123, 125, 126, 127, 128, 129, 130, 131, 132
13-0523-044	721761	122, 123, 125, 126, 127, 128, 129, 130, 131, 132
13-5626-951	725506	124, 141, 142, 143, 144, 145, 146, 147
15-2122-104	725165	189
15-5609-107	726961	198, 205
18-8430-007	725563	126
18-8432-107	725564	126
18-8440-007	724863	124
18-8442-007	724864	124
18-8450-007	721755	129
18-8452-007	721759	129
18-8452-107	721757	129
18-8460-007	721198	125
18-8462-107	721197	125
18-8470-007	722009	127
18-8480-007	722016	128
18-8484-007	722022	130
18-8486-007	722020	130
18-8520-002	724842	145, 147
18-8522-002	724840	145, 146

OE / OE NUMBER / OE NUMBER / OE	KÓD / ORDER CODE / BESTELL NR. / КОД	STRANA / PAGE / SEITE / СТРАНИЦА
18-8550-002	722636	141
18-8560-002	722610	124, 143
18-8570-001	722622	144
18-8570-101	722621	144
21-2000-004	726978	191
21-2000-045	726962	191
21-2200-004	725145	189
21-3351-707	724123	196
24-3000-007	725560	126
24-3200-007	725561	126
24-3210-007	725562	126
24-4101-007	723979	124
24-4151-007	723981	124
24-4301-007	723971	124
24-4351-007	723980	124
24-5000-007	721754	129
24-5200-007	721758	129
24-5210-007	721756	129
24-6000-007	721194	125
24-6002-507	721196	125
24-6210-007	721195	125
24-7000-007	722011	127
24-7200-007	722010	127
24-7210-007	722007	127

REJSTŘÍK / CROSS REFERENCE LIST / GEGENÜBERSTELLUNG HERSTELLER / СРАВНИТЕЛЬНАЯ ТАБЛИЦА ОРИГИНАЛЬНЫХ НОМЕРОВ

ASPÖCK

OE / OE NUMBER / OE NUMBER / OE	KÓD / ORDER CODE / BESTELL NR. / КОД	STRANA / PAGE / SEITE / СТРАНИЦА	OE / OE NUMBER / OE NUMBER / OE	KÓD / ORDER CODE / BESTELL NR. / КОД	STRANA / PAGE / SEITE / СТРАНИЦА
24-8000-007	722015	128	31-3104-017	724203	196
24-8210-007	722014	128	31-3302-027	725523	180
24-8400-007	722019	130	31-3302-037	725505	180
24-8610-007	722017	130	31-3303-027	725522	180
25-2000-507	724831	145	31-3303-037	725504	180
25-2010-507	724847	147	31-3304-047	724114	195
25-2200-007	724833	145	31-3304-057	724112	195
25-2210-007	724835	146	31-3304-097	724167	195
25-2400-507	724823	145	31-3305-067	725521	180
25-2410-507	724846	147	31-3305-237	724148	196
25-2600-007	724832	145	31-3306-067	725520	180
25-2610-007	724836	146	31-3306-237	724147	196
25-5000-507	722615	141	31-3364-007	724131	195
25-5100-507	722623	141	31-3364-027	724155	195
25-5400-507	722607	141	31-3364-057	724162	195
25-5500-507	722632	141	31-5004-007	723984	161
25-6000-507	722608	142	31-5004-087	723982	161
25-6011-517	722604	143	31-5004-097	723985	161
25-6400-507	722609	142	31-5064-027	723986	161
25-6411-517	722602	143	31-5064-067	723987	161
25-7000-507	722617	144	31-6404-017	724019	193
25-7400-507	722616	144	31-6604-077	726953	185
26-3010-004	724195	215	31-6614-037	723992	185
31-2004-017	724051	190	31-6614-077	726661	185
31-2064-017	726955	190	31-6700-027	726993	198
31-2064-037	726963	190	31-6700-037	723150	198
31-2064-217	724120	190	31-6704-117	723150	198
31-2064-717	724052	190	31-6800-017	724021	205
31-2104-017	724050	191	31-6904-017	724018	186
31-2214-017	726956	188	31-6904-037	724688	186
31-2214-037	726965	188	31-7104-007	726966	198
31-2214-117	724044	188	31-7204-007	726964	205
31-2264-017	724045	188	31-7704-017	725540	186
31-2304-017	726992	189	31-7704-037	725539	186
31-2304-037	726996	189	31-7804-017	723969	193
31-2364-017	724049	189	31-7804-057	723970	193
31-2364-087	726659	189	38-8200-007	720080	60
31-2364-107	726664	189	39-6400-017	720083	60
31-3104-007	724204	196	68-5018-024	722529	186

